

Nancy Clanton, PE, FIES, FIALD, LC
LEED Fellow

Clanton & Associates, Inc.

www.clantonassociates.com

Trends in Lighting Technology



1. Typical Questions Asked about LEDs

Are LEDs really energy efficient?

Do LEDs last a long time?

Are LEDs cost effective?

What's the difference in quality?

How do I select the best application?

How do I select the right equipment?

What else?

LED Basics



Blue Light Pump



Directional



Energy Use

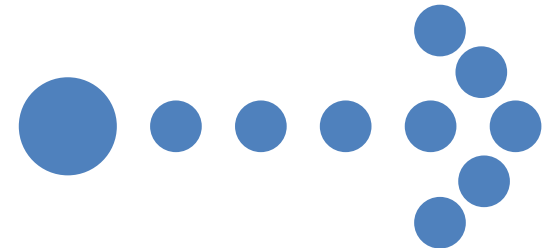
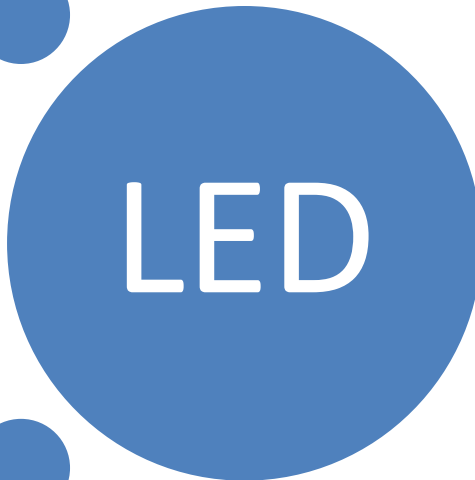

Light Emitting Diode

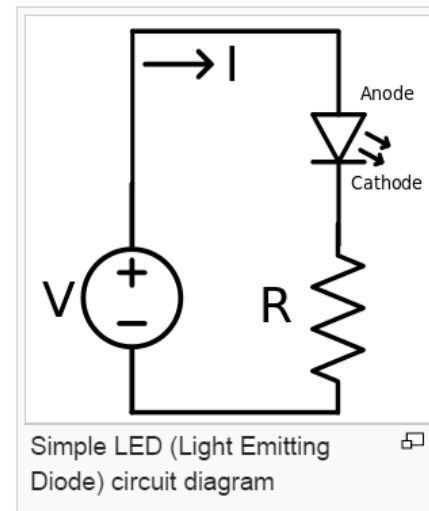

Creating White Light

<p>White Light</p> <p>Phosphors</p> <p>Blue or UV LED</p>	<p>White Light</p> <p>Color mixing optics</p> <p>Multi-colored LEDs</p>	<p>White Light</p> <p>Color mixing optics</p> <p>Colored and pcLEDs</p>
<p>PHOSPHOR-CONVERTED LED</p> <p>Phosphors are used to convert blue or near-ultraviolet light from the LED into white light</p>	<p>COLOR-MIXED LED</p> <p>Mixing the proper amount of light from red, green, and blue LEDs yields white light</p>	<p>HYBRID METHOD LED</p> <p>A hybrid approach uses both phosphor-converted and discrete monochromatic LEDs</p>

Blue pump + phosphor = white light

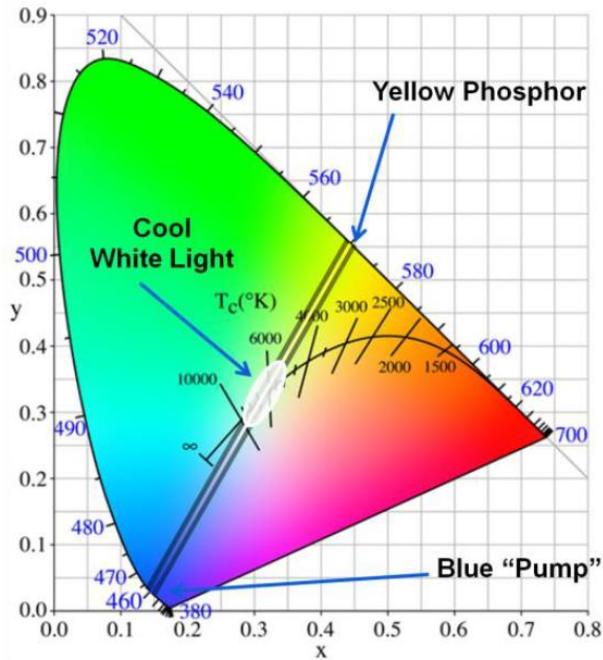

Figure 5. Blue pump with yellow phosphor produces cool white light.
Illustrations courtesy of Philips Lumileds Lighting Company.

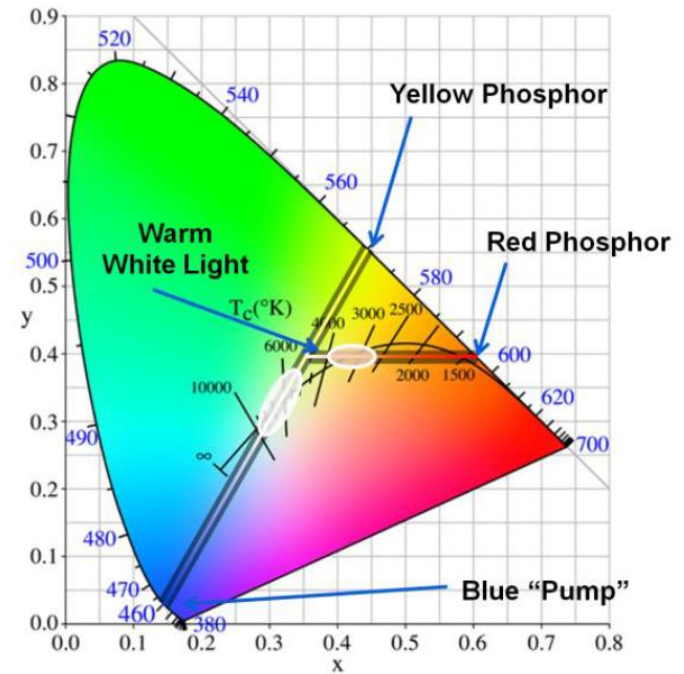
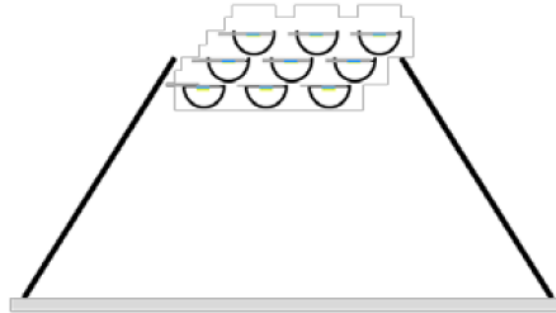

Figure 6. Blue pump with yellow + red phosphors produces warm white light.
Illustrations courtesy of Philips Lumileds Lighting Company.

Downlight Application

White LEDs +
Reflector &
Diffuser



Blue LEDs +
Reflector &
Phosphor Disc

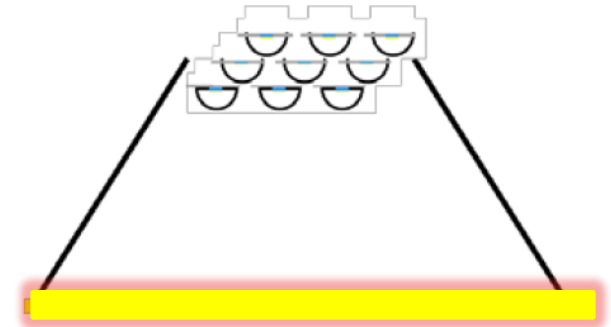

Remote Phosphor 20% more efficient

TLED – UC Davis CLTC Report

Luminaire efficacy and luminous output by product category³

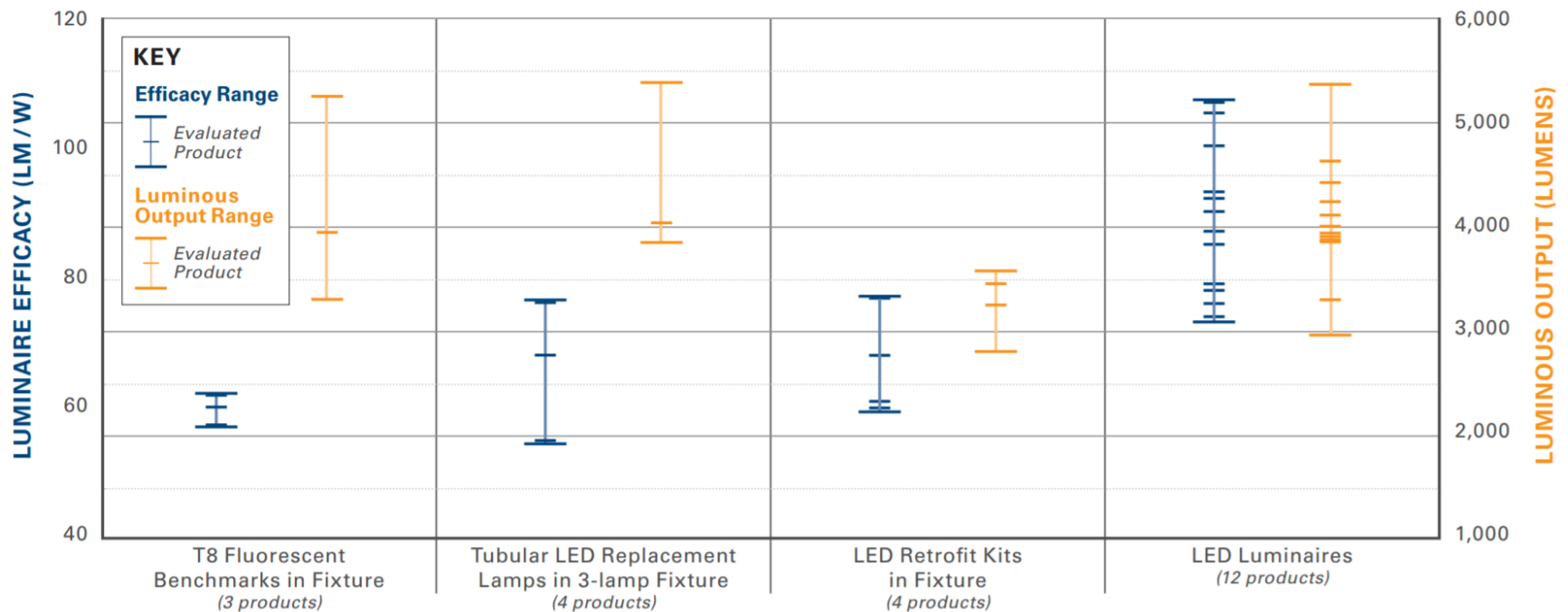

³ CALiPER Exploratory Study: Recessed Troffer Lighting, Prepared for the U.S. Department of Energy by the Pacific Northwest National Laboratory, PNNL-22348, 2013.

http://cltc.ucdavis.edu/sites/default/files/files/publication/LED_Retrofit_Options_Linear_Fluorescent_FINAL.pdf

TLED - UC Davis CLTC report

- LED replacement lamps typically require wiring modifications to the existing luminaire, increasing labor costs and raising safety concerns
- Installation and maintenance teams must observe safety protocols and pay careful attention to luminaire labeling, both during and after installation
- The performance characteristics and energy savings of tubular LED replacement products vary widely from product to product, even within the same product category
- Tubular LED replacement lamps often require un-shunted lamp-holders for successful operation; facility managers should keep this in mind during project planning and preparation
- Thermal performance should be analyzed in the specific troffer considered for retrofit, with attention paid to how the LED lamp manages heat
- As a directional source, LED replacement lamps require custom optics to achieve distribution patterns like those typical of omni-directional fluorescent lights

http://cltc.ucdavis.edu/sites/default/files/files/publication/LED_Retrofit_Options_Linear_Fluorescent_FINAL.pdf

Some LED Characteristics

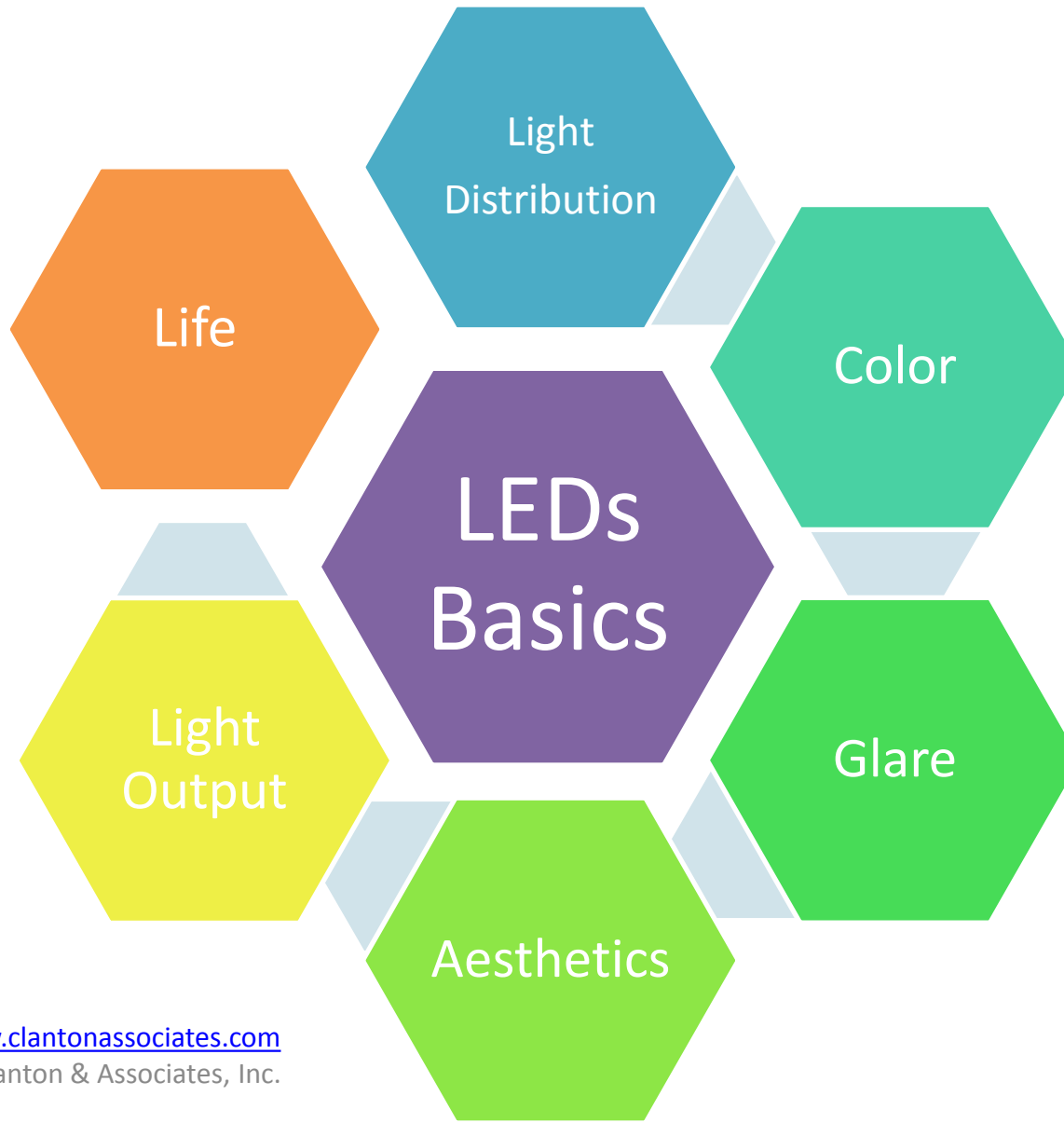

Light Distribution – *(LM-79 report for photometric .ies files)*



NGL exterior lighting judging 2012 <http://www.ngldc.org/>



US Embassy Innovation Center in Helsinki

Color – CRI (<70 exterior; <80 interior)

LM-79 and Energy Star



US Embassy Innovation Center in Helsinki

www.clantonassociates.com

© Clanton & Associates, Inc.

Color – CCT

LM-79 and Energy Star

Measures light color

- "Cool" colors (3500–5500 K)
- "Warm" colors (2700–3000 K)
- Use warm colors!!



Aspen Institute, Aspen Colorado

Life - Do LEDs last a long time? – *It depends on operating temperature*

- L70 (hours) = time to 70% lumen maintenance

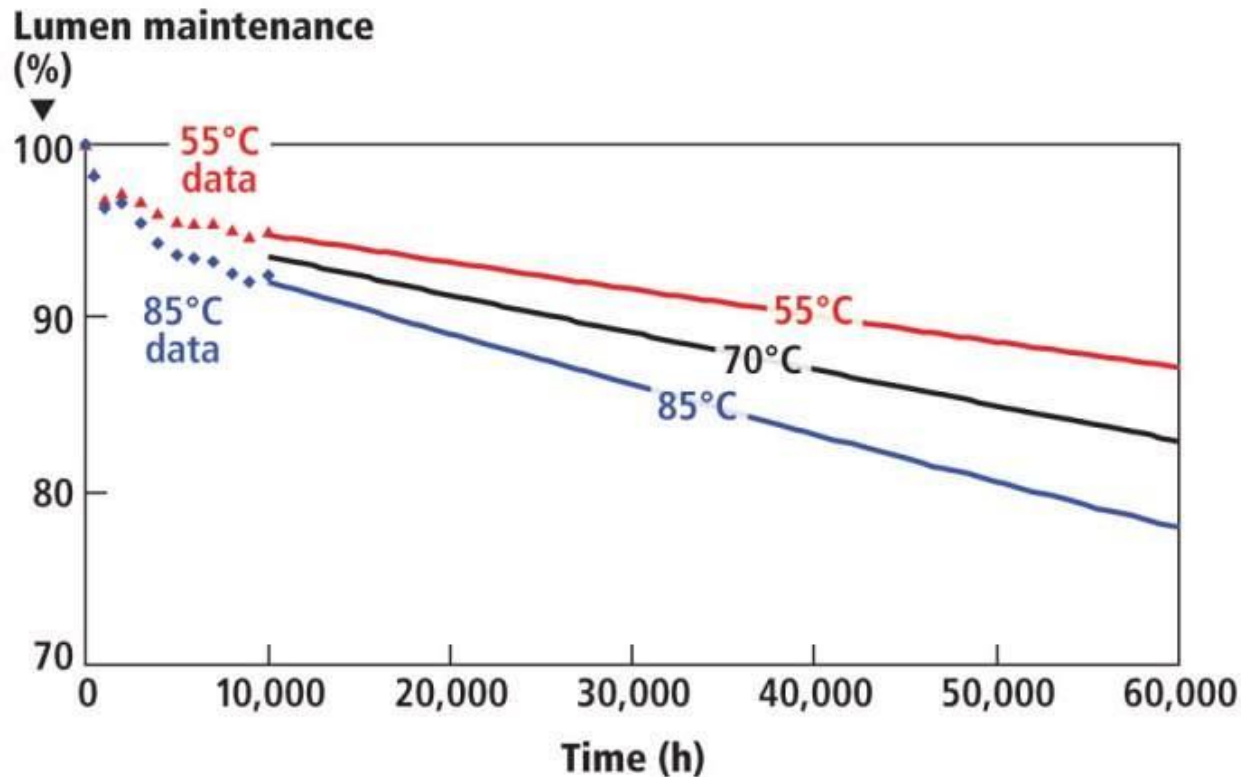

Glare

LM-79 photometric luminance

Exterior – TM-15 BUG

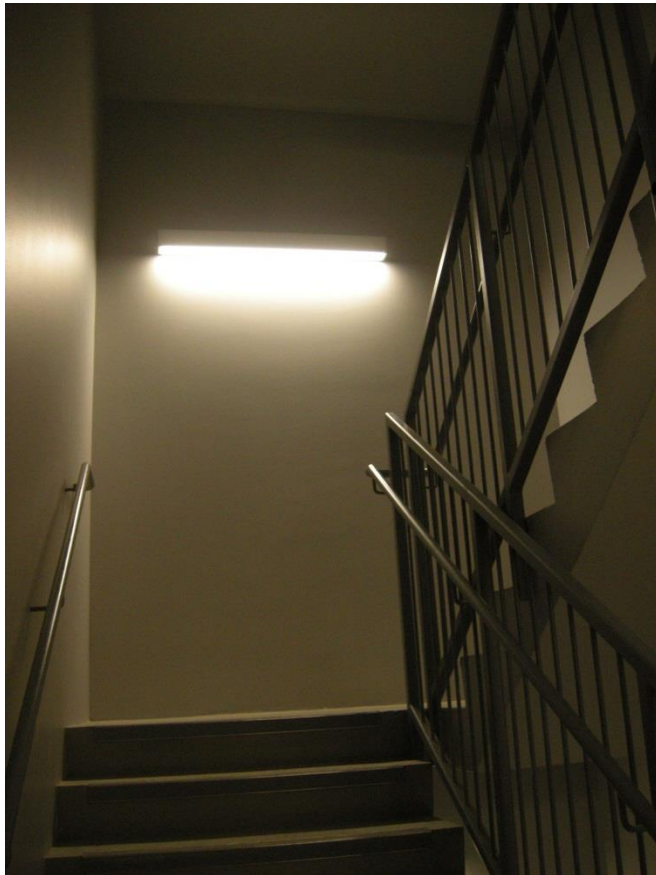

US Embassy Innovation Center in Helsinki



NGL exterior lighting judging 2012 <http://www.ngldc.org/>

Aesthetics



US Embassy Innovation Center in Helsinki

Light Source Replacement Issues

- Heat management issues
 - Base up lamps may overheat
 - IC rated luminaire
- Control system compatibility



USGBC Headquarters – Washington DC

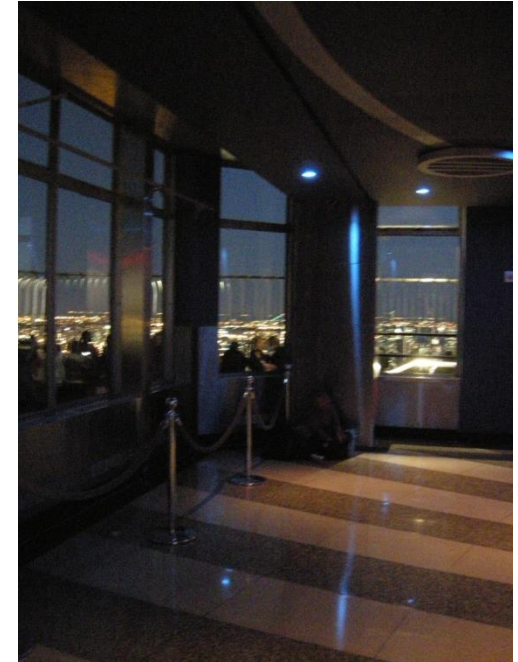

The Empire State Building – Clanton & Associates

Heat Management – Power Conversion of White Light Sources

Description	Incandescent* (60W)	Fluorescent* (Typical linear CW)	Metal Halide*	LED**
Visible Light	8%	21%	27%	15-25%
IR	73%	37%	17%	≈0%
UV	0%	0%	19%	0%
Total Radiant Energy	81%	58%	63%	15-25%
Heat (Conduction + Convection)	19%	42%	37%	75-85%
Total	100%	100%	100%	100%

* IESNA Handbook and Osram Sylvania

** Varies depending on LED efficacy

Source: DOE Solid State Lighting – Using Light Emitting Diodes www1.eere.energy.gov/buildings/ssl/m/comparing_lights.html

LED Retrofit Issues

- Caution: inserting LEDs into existing luminaires
- Recommendation: Replace entire luminaire with LED luminaire
- Power Quality – affecting existing infrastructure



Dimming and Power Quality Issues

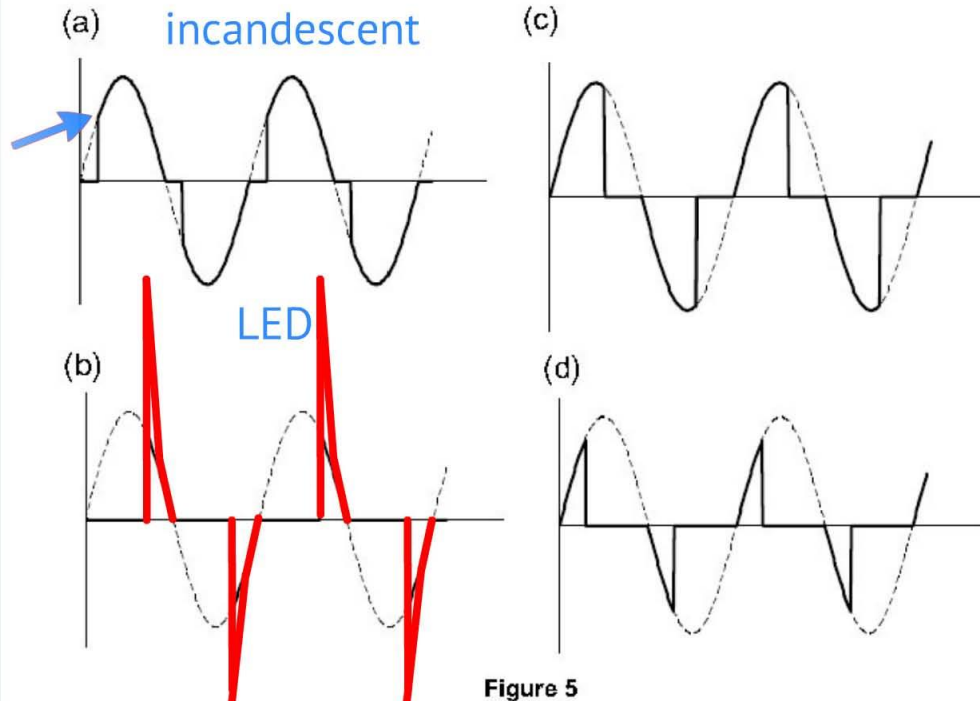

Example Voltage Waveforms Applied to the Lamp from Phase-Cut Dimmers:

- (a) leading edge, high light level;
- (b) leading edge, low light level;
- (c) trailing edge, high light level;
- (d) trailing edge, low light level.

Dashed line represents uncut line voltage, what would be applied if the switch were "on."

Repetitive Peak Current

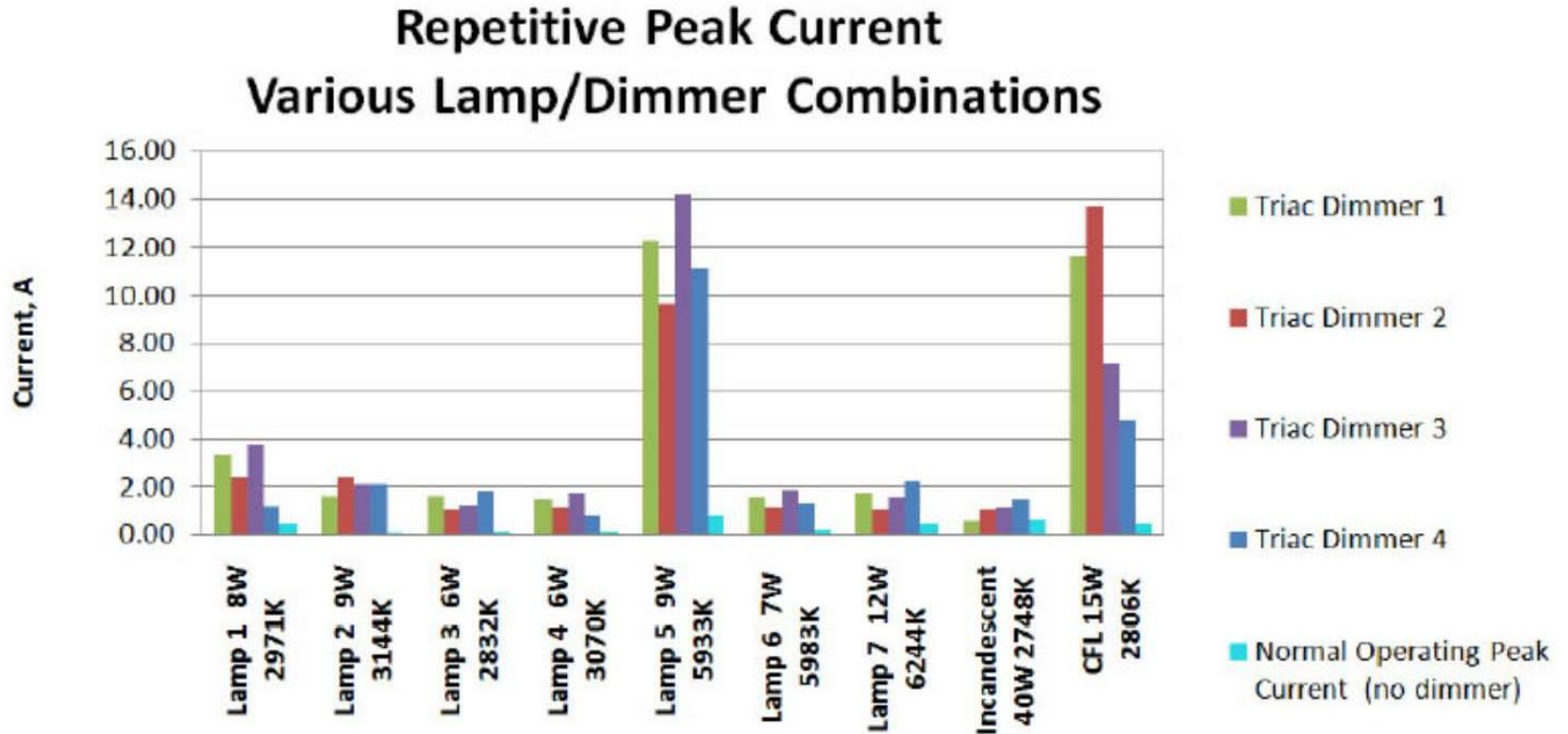

Figure 2. Repetitive peak current for various lamps and dimmers.

Source: Lighting Research Center

www.clantonassociates.com

© Clanton & Associates, Inc.

Equipment Coordination

- Light Sources
- Luminaires
- Drivers
- Controls

www.clantonassociates.com

© Clanton & Associates, Inc.



BEST Applications

- Close to the task application
 - Task
 - Grazing surfaces
- Directional
 - Accent
- Lower output



Encana – Denver, CO

Other Applications

- Ambient lighting
- Higher directional light output
- Full dimming range



Hospitality Applications



www.clantonassociates.com

© Clanton & Associates, Inc.









Correlated Color Temperature (CCT)



www.clantonassociates.com

© Clanton & Associates, Inc.

Correlated Color Temperature (CCT)

LM-79 and Energy Star

"Warm" colors
(2700–3000 K)

"Cool" colors
(3500–5500 K)

www.clantonassociates.com

© Clanton & Associates, Inc.



Color Rendering Index

LM-79 and Energy Star



COMPACT FLUORESCENT
50 CRI



STANDARD LED
80 CRI



LUX HIGH CRI
90+ CRI

<http://www.luxtg.com/color-rendering-index-cri/>

www.clantonassociates.com

© Clanton & Associates, Inc.

Spectral Distribution (IES TM-30)



Daylight

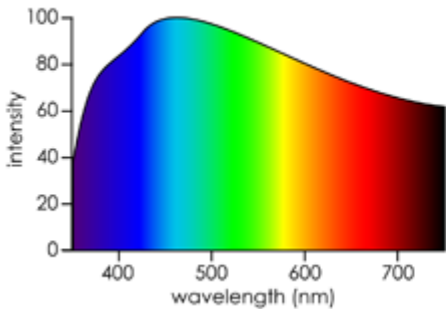

Incandescent

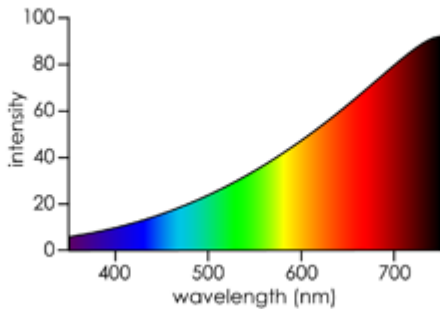

Fluorescent

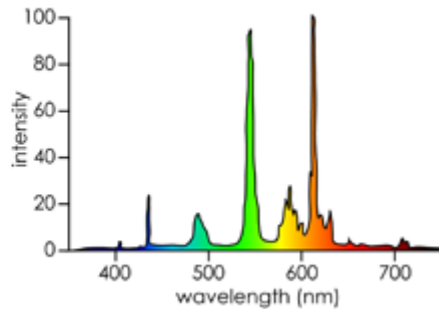

Warm White LED

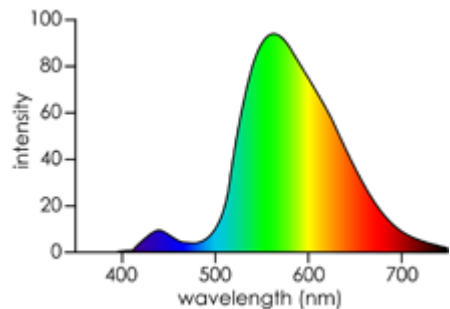

SPD graphs from GLARminy

www.clantonassociates.com

© Clanton & Associates, Inc

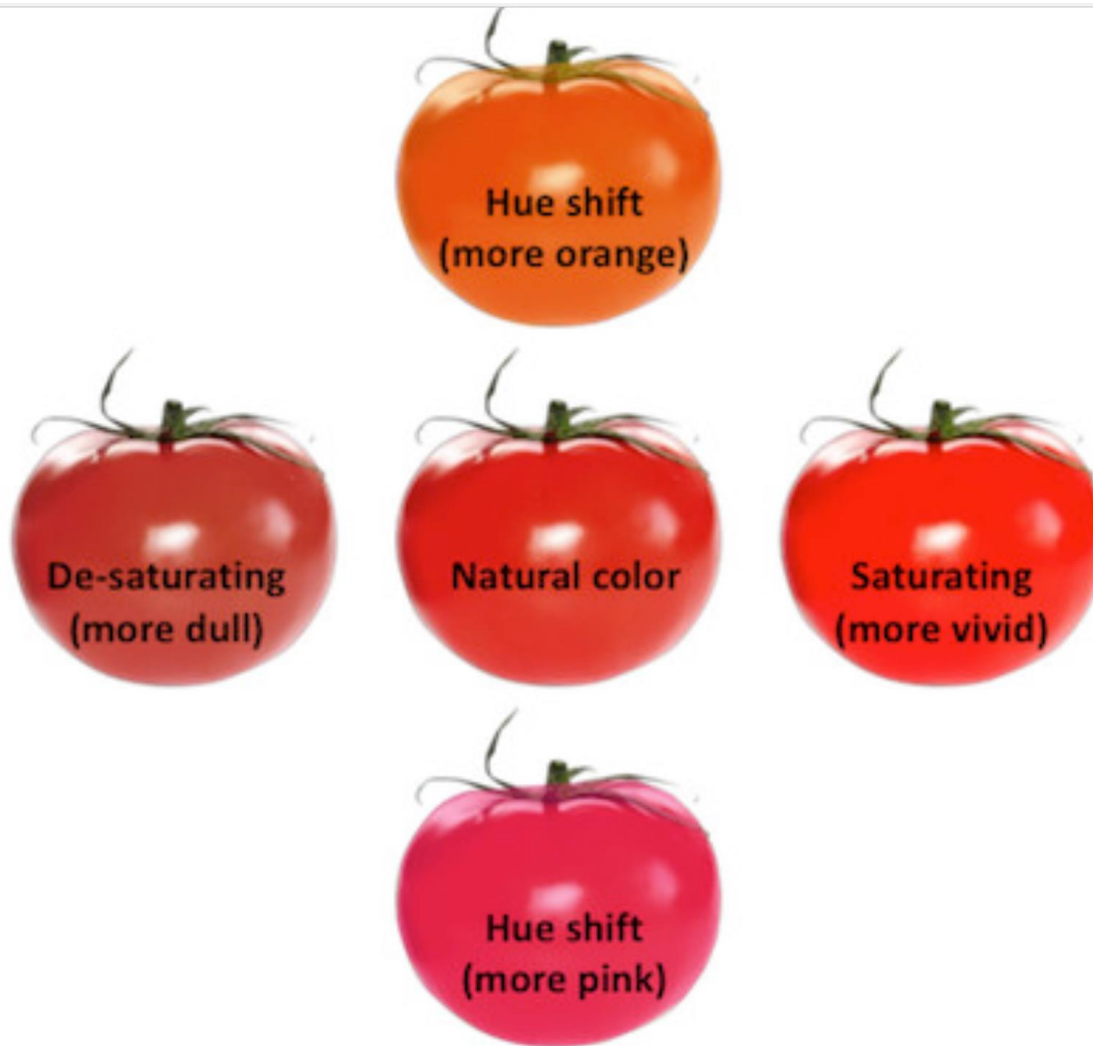

March 2016 - by Aurelien David, Soraa's Chief Scientist

www.clantonassociates.com

© Clanton & Associates, Inc.

IES TM-30-15 – Fidelity Index

- Similar to CRI but...
 - 99 Color Samples

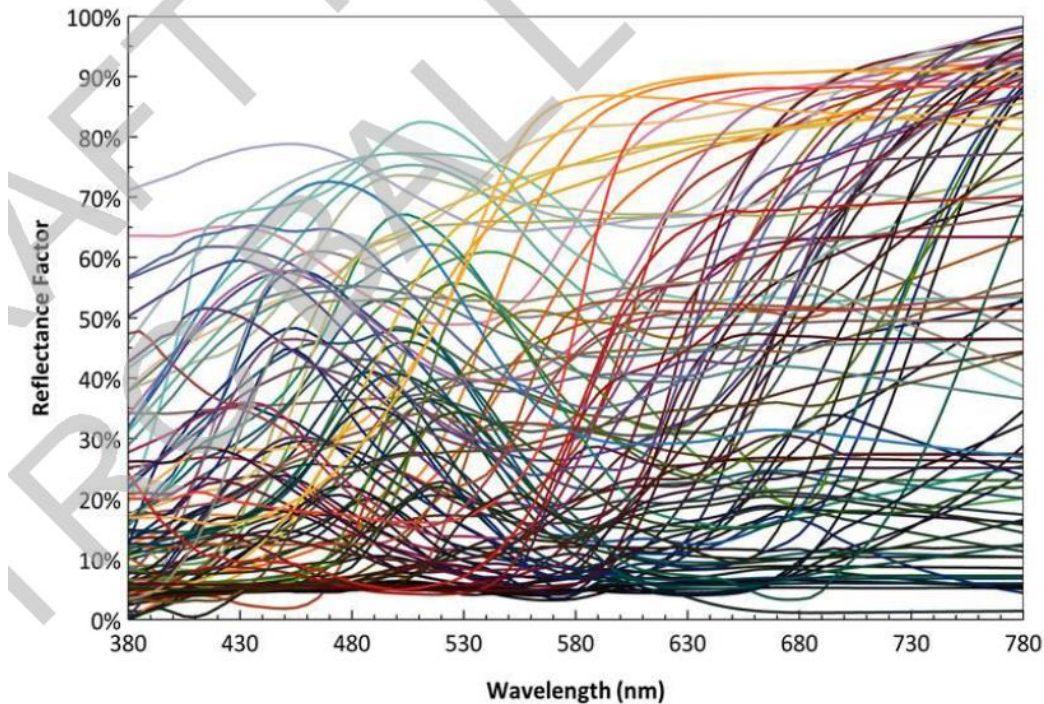

www.clantonassociates.com

© Clanton & Associates, Inc.

IES TM-30-15 – Gamut Index

- Greater than 100 = increased saturation
- Less than 100 = decreased saturation

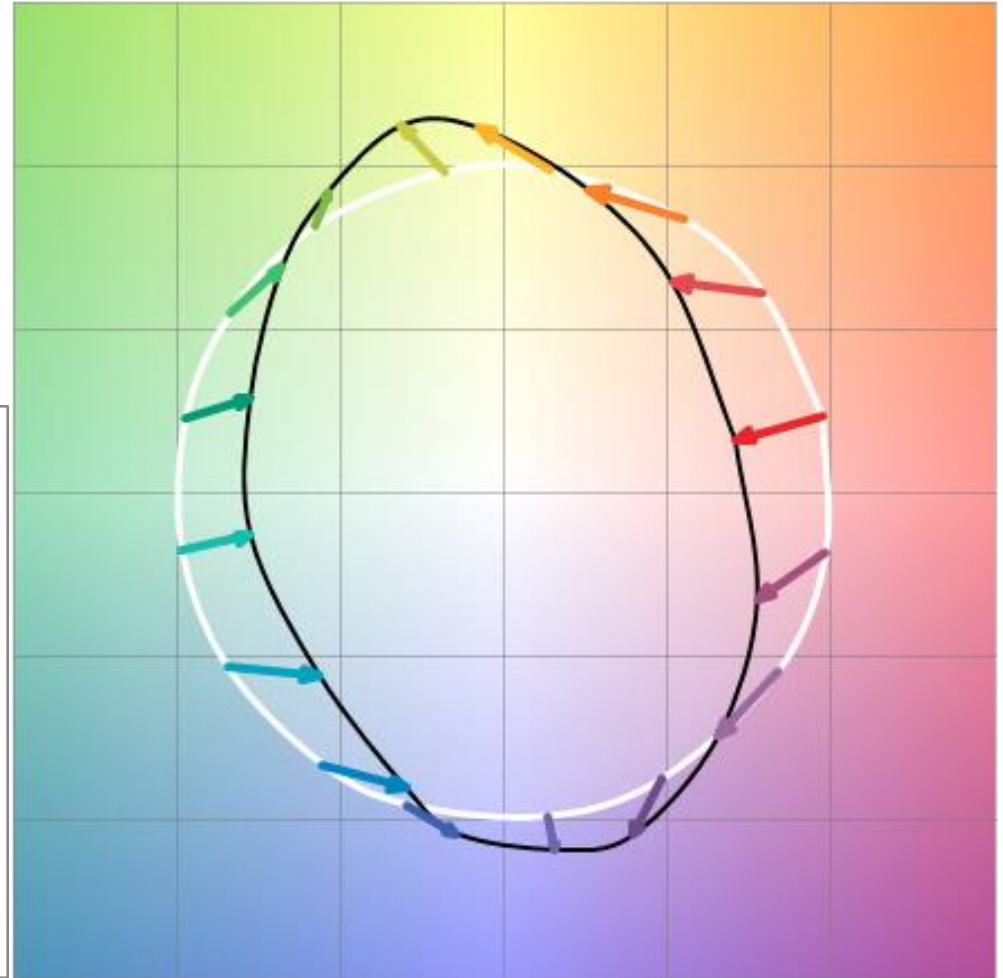
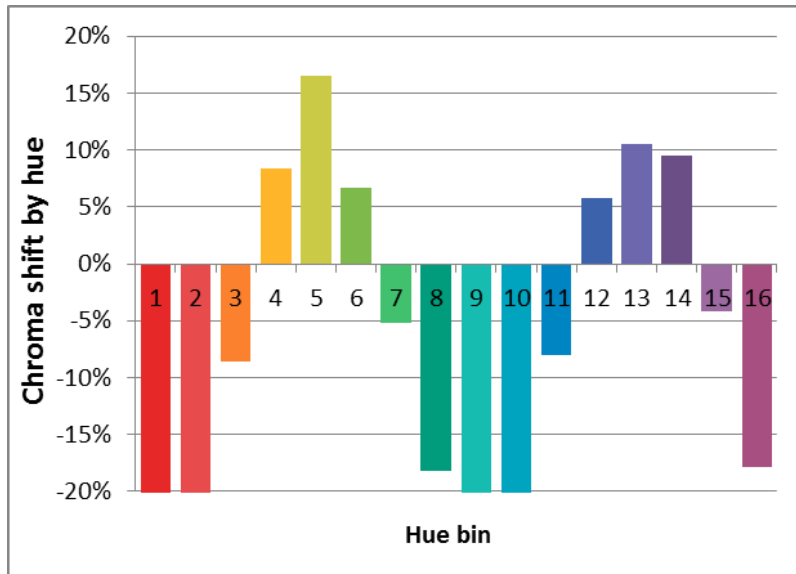

TM-30-15 – Two-Axis System

- Compare sources
 - Fidelity (accuracy)
 - Gamut (saturation)

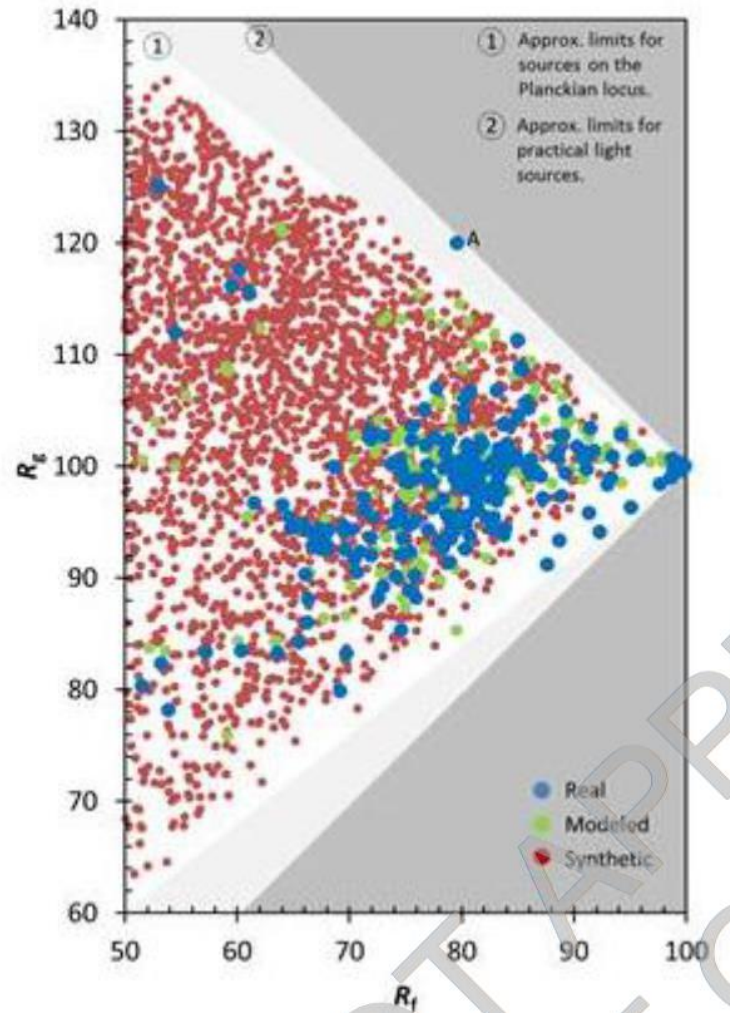
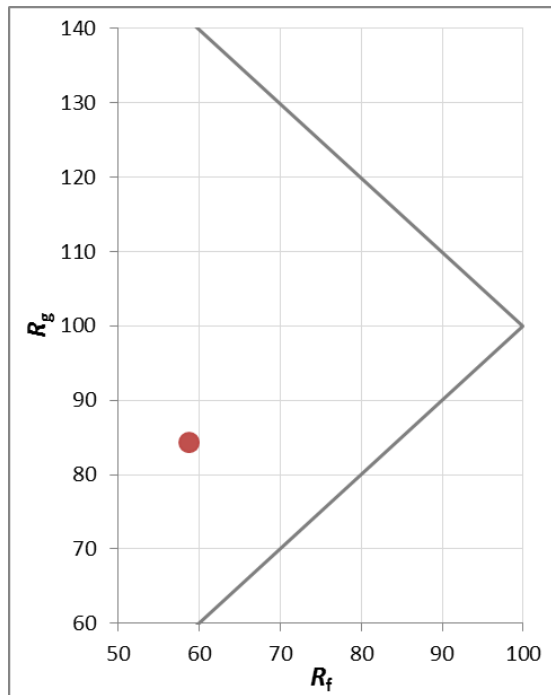

www.clantonassociates.com

© Clanton & Associates, Inc.



High saturation R_f 65 R_g 115



<https://www.ies.org/store/technical-memoranda/ies-method-for-evaluating-light-source-color-rendition/>

www.clantonassociates.com



Strong desaturation R_f 65 R_g 80



<https://www.ies.org/store/technical-memoranda/ies-method-for-evaluating-light-source-color-rendition/>

www.clantonassociates.com



Importance of Circadian Cycles

- Patterns of Light and Dark are key to “Entrainment”

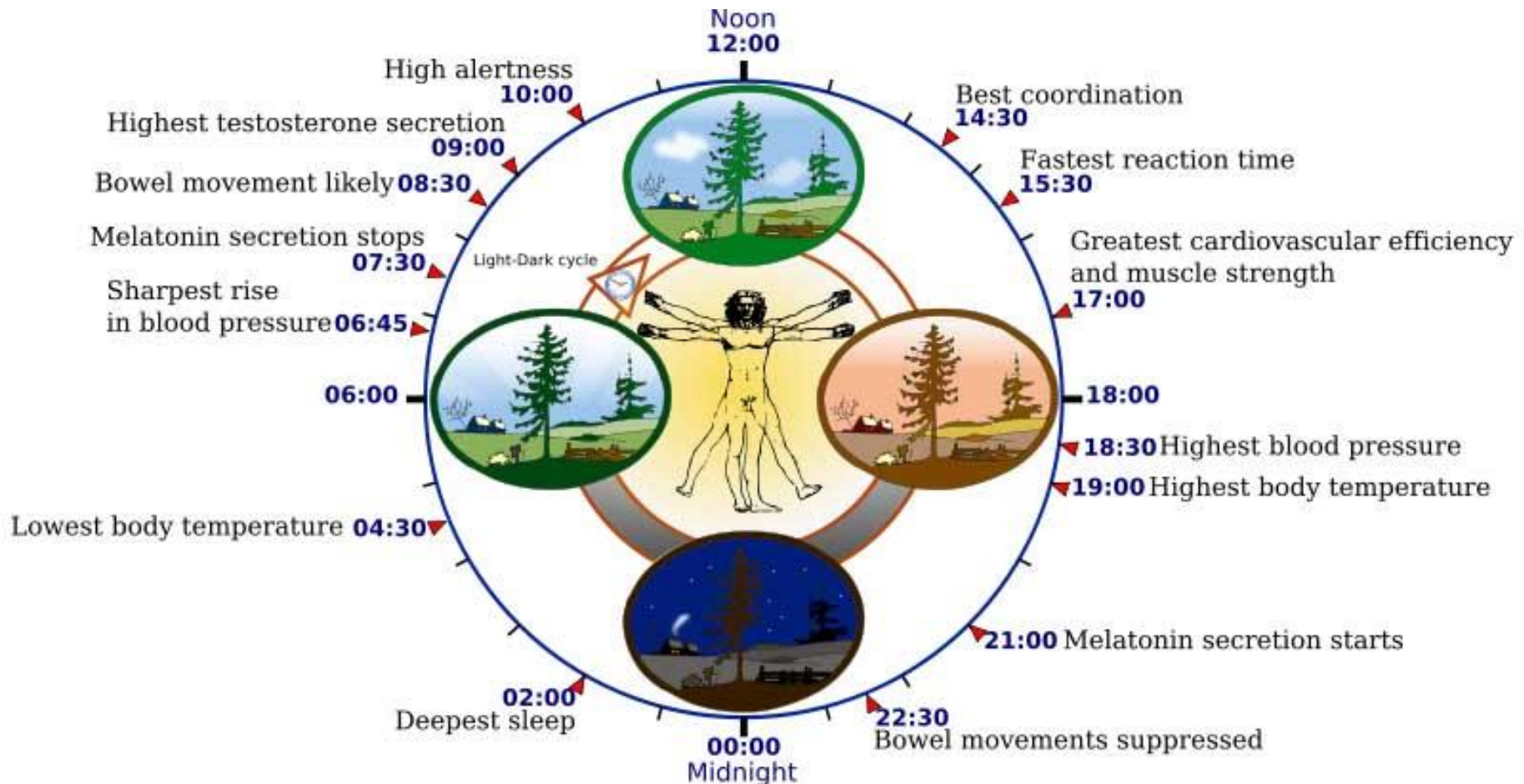

Sky glow mapping

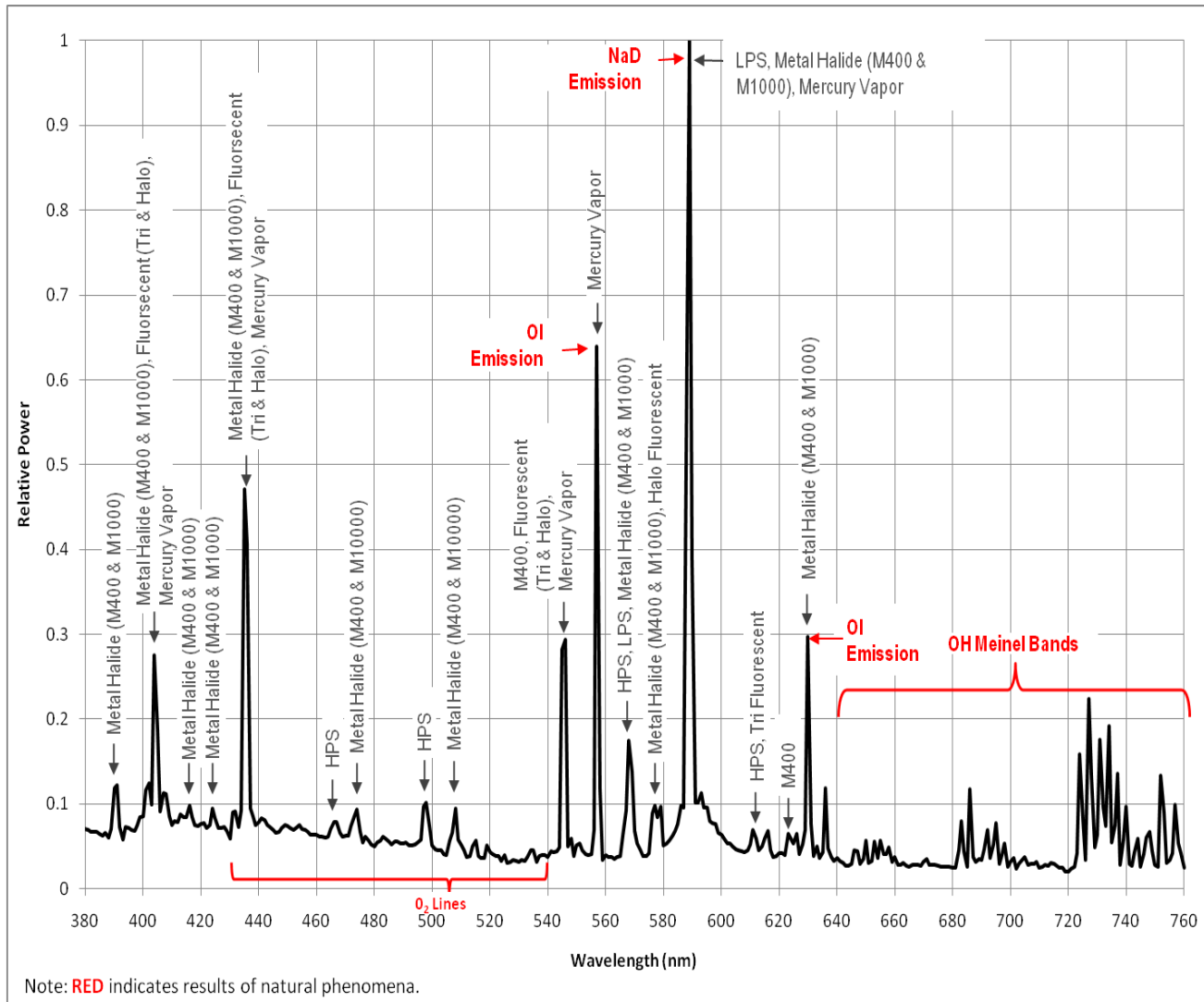

Ocular Action Spectra – Melanopic Lumen

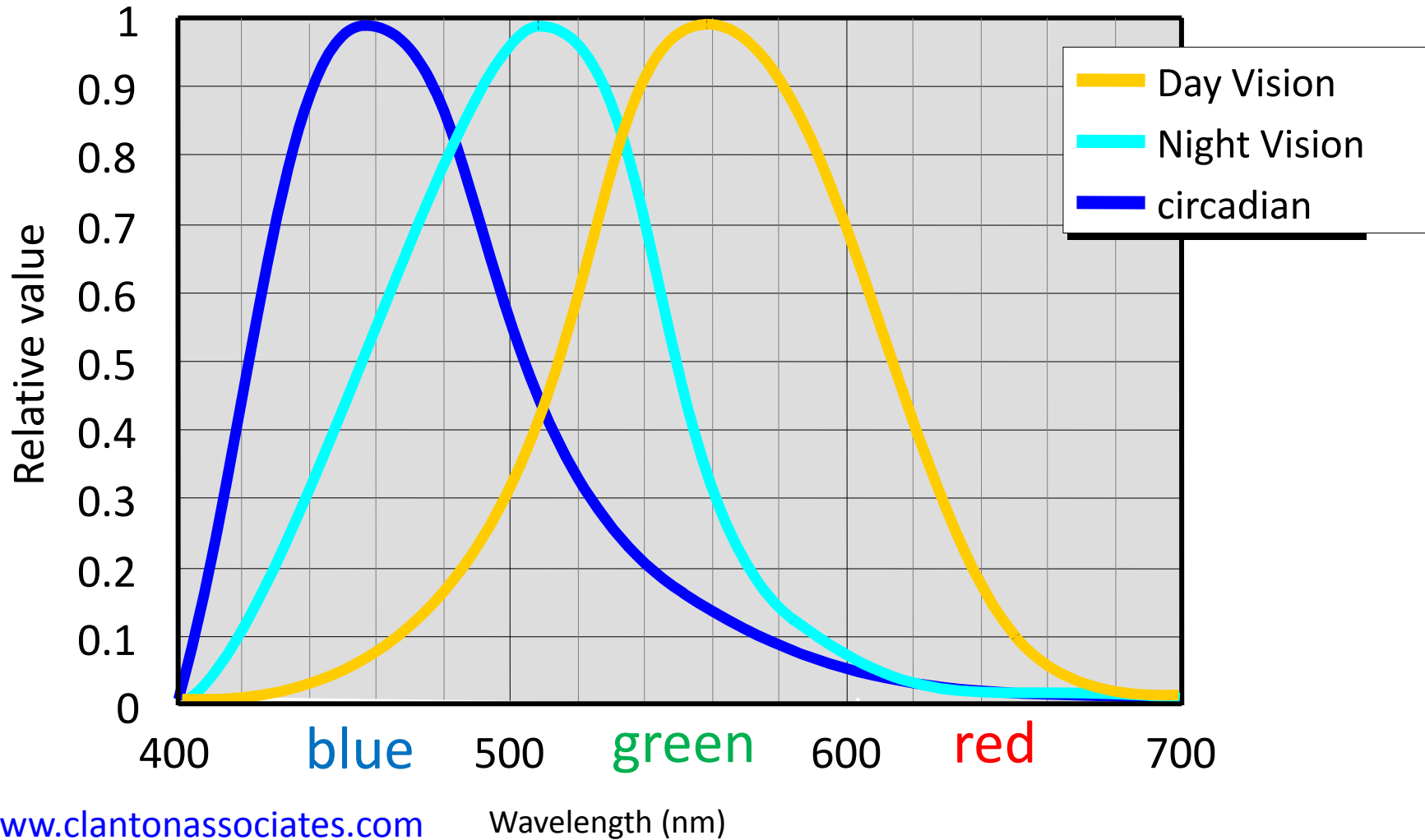

What metrics should we achieve ... Circadian Stimulus (CS), ???

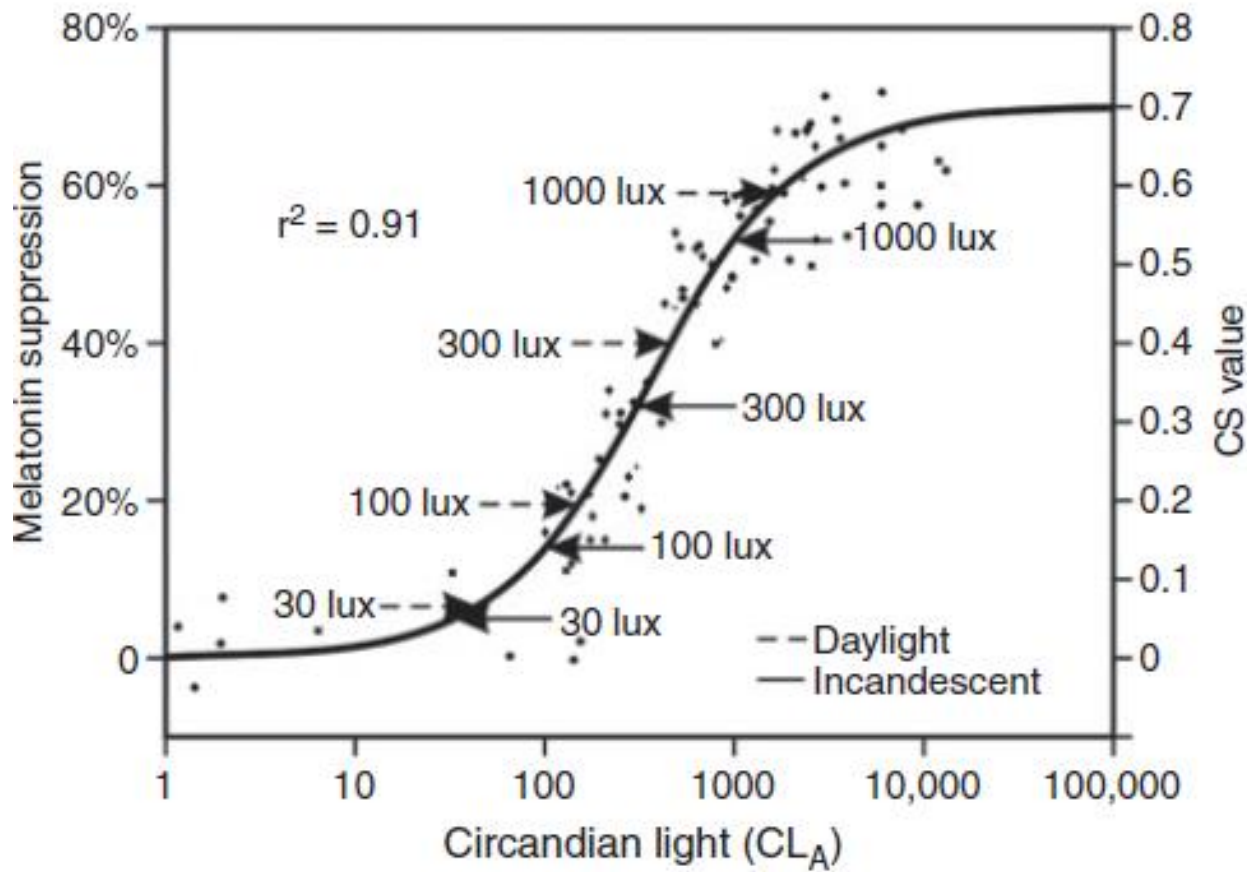

Source: Rea and Figueiro (2015)

www.clantonassociates.com

© Clanton & Associates, Inc.

Using the Circadian Stimulus calculator (LRC)

SOURCE	CS
Equal energy	0.576
D65	0.589
Incandescent (A-lamp)	0.523
Halogen 3277 K	0.553
CFL	0.473
RE 3500 K	0.535
Cool white	0.428
Design50	0.526
PS MH	0.447
Ceramic MH	0.492
HPS	0.377
LED 2700 K	0.499
LED 6500 K	0.563
LED 470nm	0.691
Red LED	0.01

Source: Light Research Center CS Calculator

http://www.lrc.rpi.edu/resources/CSCalculator_2017_05_05.xlsm

Is there a difference between genders?



Color Tuning per time of day



Is white tuning achieving the expected results?

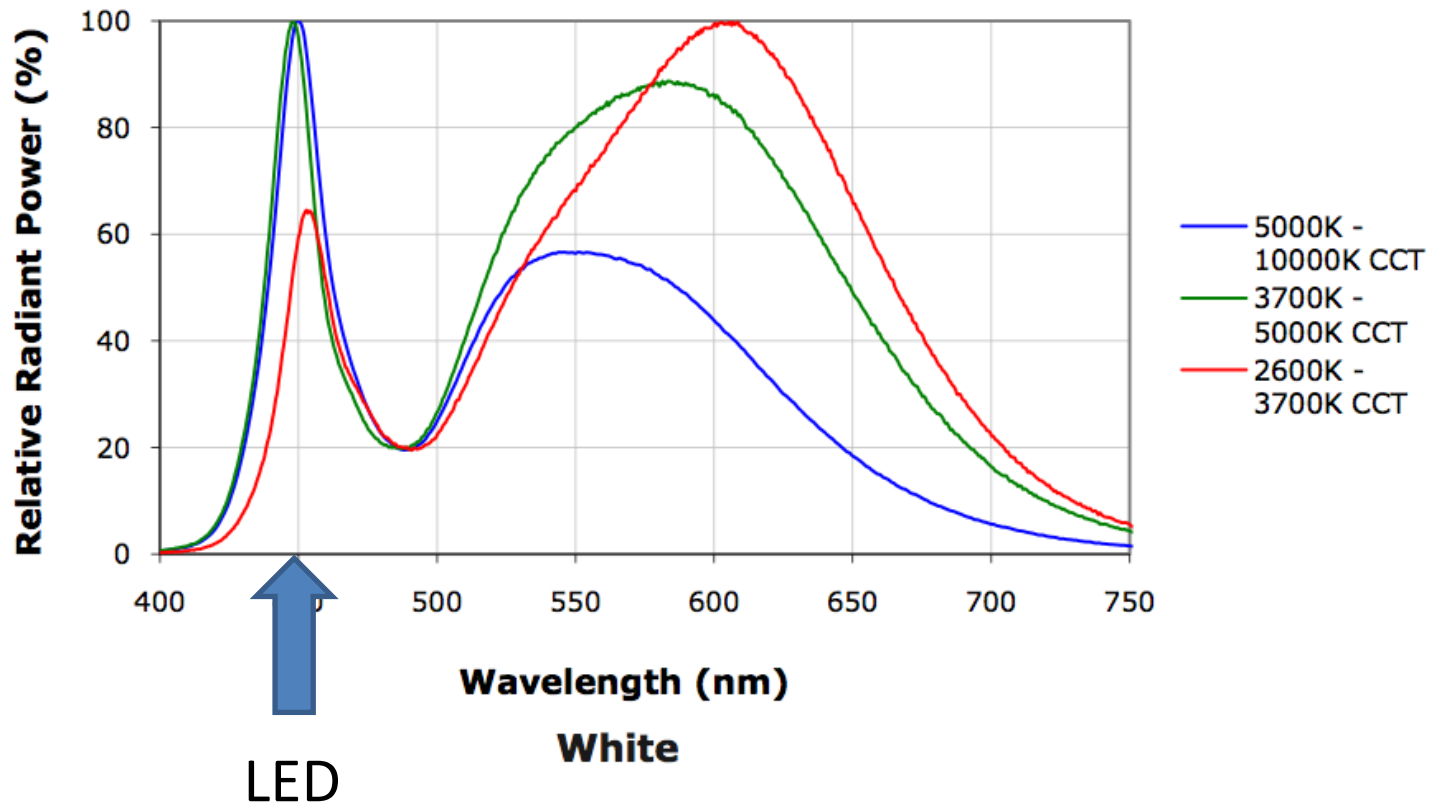

What are the unexpected consequences?

- Static environments?
 - Too much CS at the wrong time?
 - High blue content ... visual issues?
 - Not enough daylight and views?
-
- What is driving the design ... CS?



Residential DC Distribution?

Renewables Generate DC

Converts to AC

Powering native DC loads

Potential Energy Savings (14% - 25% with storage)

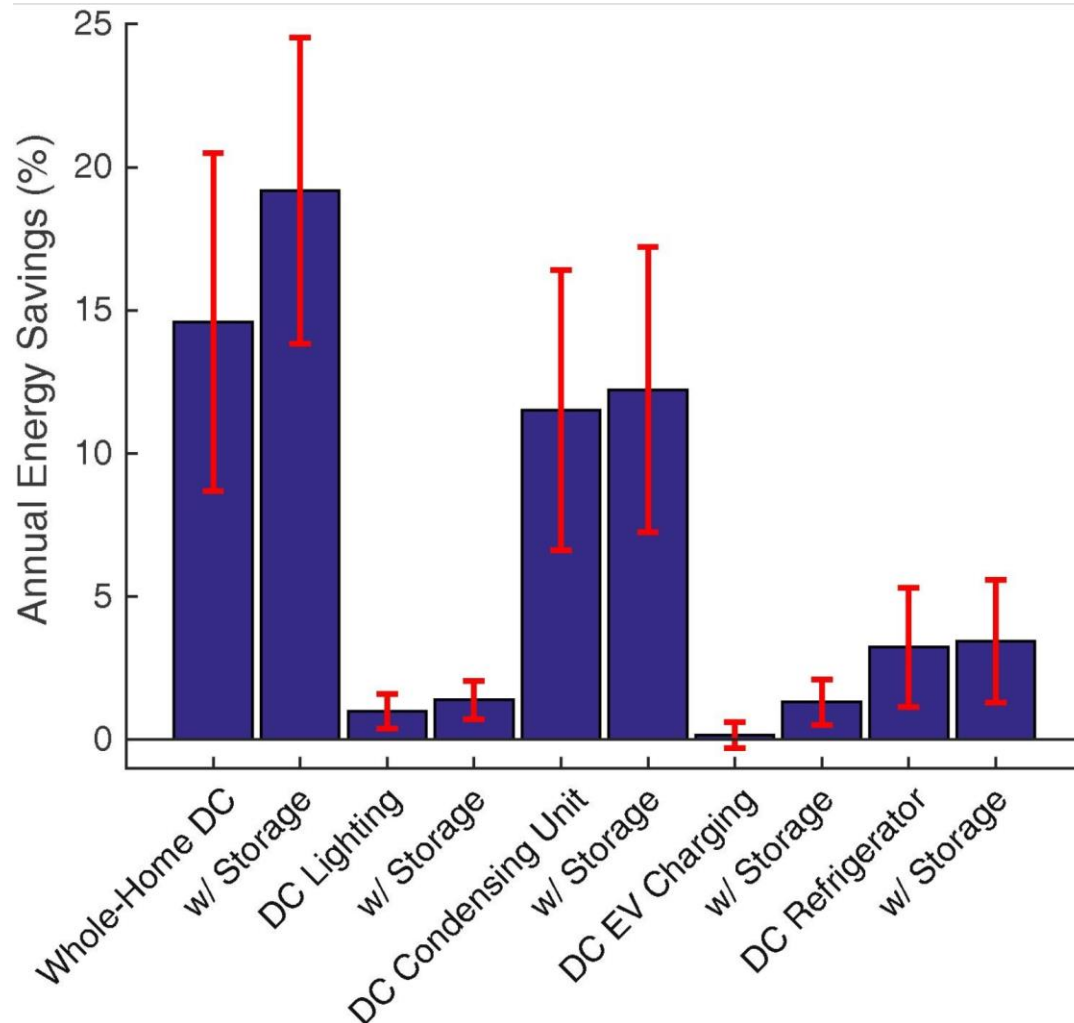

City of LA Building an e-Highway



<https://www.citylab.com/life/2014/09/los-angeles-is-building-an-e-highway/380914/>

www.clantonassociates.com
© Clanton & Associates, Inc.

Charge as you drive ...



www.citylab.com/life/2015/11/netherlands-dutch-solar-powered-bike-lane-cycling-solaroad/416601/

www.clantonassociates.com

© Clanton & Associates, Inc.

PV charging ...



www.citylab.com/life/2015/11/netherlands-dutch-solar-powered-bike-lane-cycling-solaroad/416601/

www.clantonassociates.com
© Clanton & Associates, Inc.

Controls – GPS Device to Lighting

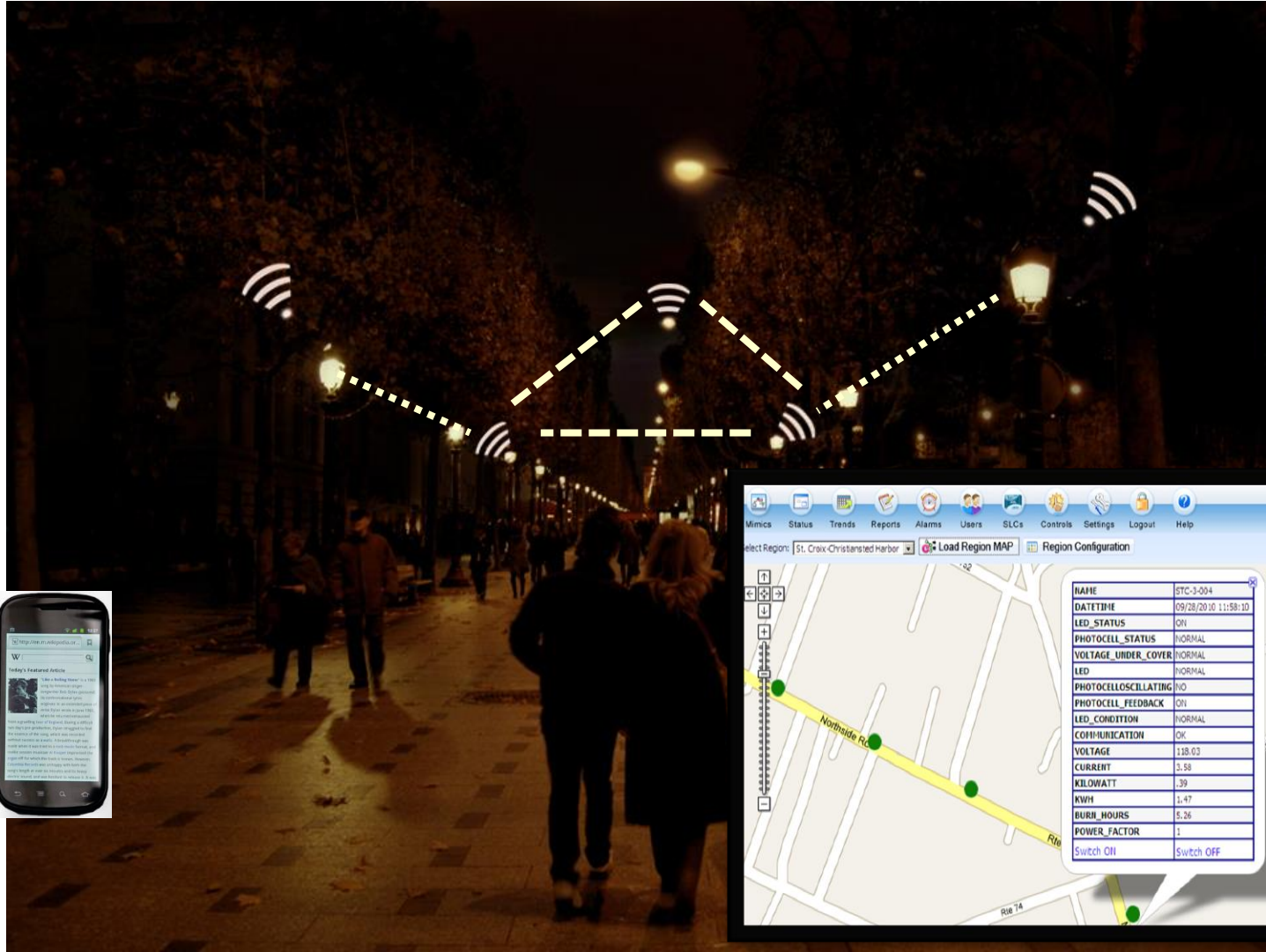

One Luminaire = Multiple Effects



Osram OmniPoint™

<https://www.youtube.com/watch?v=ueQ-10tQ80A>

Design Palette of OLED Technology



Rectangular & Flexible



Acuity Brands

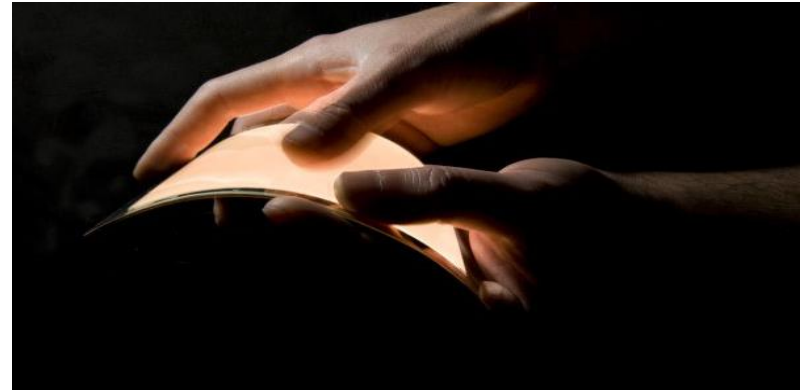

Acuity Brands

www.clantonassociates.com

© Clanton & Associates, Inc.

MIRRORS

LENS

REFLECTOR

Lasers (2X light output for same LED wattage)

www.clantonassociates.com

© Clanton & Associates, Inc.

Contact Information

Nancy Clanton, PE, FIES, FIALD,
LEED Fellow, RMI Fellow
Clanton & Associates, Inc.
4699 Nautilus Court South
Suite 102
Boulder, CO 80301

303-530-7229 (X101)

Nancy@Clantonassociates.com

www.clantonassociates.com

www.clantonassociates.com

© Clanton & Associates, Inc.

