

OLD TOWN HISTORIC DISTRICT DESIGN STANDARDS FORT COLLINS, COLORADO



page left intentionally blank

Credits

This project was paid for in part by a State Historical Fund Grant from History Colorado, the Colorado Historical Society. Project # 2013-M2-032

City Council

Karen Weitkunat – Mayor

Gerry Horak – Mayor Pro Tem

Bob Overbeck

Lisa Poppaw

Gino Campana

Wade Troxell

Ross Cunniff

Landmark Preservation Commission

Ron Sladek

Doug Ernest

Pat Tvede

Dave Lingle

Belinda Zink

Alexandra Wallace

Maren Bzdek

Meg Dunn

Kristin Gensmer

Planning and Zoning Board

Jennifer Carpenter

Jeffrey Schneider

Kristin Kirkpatrick

Gerald Hart

Emily Heinz

Jeff Hanson

Michael Hobbs

Historic Preservation Staff

Karen McWilliams

Josh Weinberg

Downtown Development Authority Staff

Matt Robenalt

Todd Dangerfield

Derek Getto



Prepared by:

Winter & Company

1265 Yellow Pine Avenue

Boulder, CO 80304

303.440.8445

www.winterandcompany.net

TABLE OF CONTENTS

INTRODUCTION

Overview	3
About This Document	4
What are Design Standards	4
Policies Underlying the Design Standards	5
Sustainability - Social, Economic and	
Environmental Benefits of Historic Preservation	7
The Development of Old Town Fort Collins	9

I. USING THE DESIGN GUIDELINES

Design Review System	15
Where the Design Standards Apply	16
Design Standards Organization	17

II.. PLANNING A PRESERVATION PROJECT

What Does Historic Preservation Mean	23
Planning a Preservation Project	24
Case Studies	29
Designing in Context	38
Historic Architectural Styles	39
Overarching Preservation Principles	40

III. DESIGN STANDARDS FOR THE

TREATMENT OF HISTORIC RESOURCES

Architectural Details	43
Materials and Finishes	47
Windows	50
Doors and Entries	55
Commercial Storefronts	57
Historic Roofs	59
Exposed Historic Foundations	59
Loading Docks	60
Color	60
Existing Additions	62
New Additions and Accessory Structures	62
Planning for Energy Efficiency	64
Accessibility	68
Phasing Preservation Improvements	68
Temporary Stabilization Treatments	69
Existing Historic Alterations	69

IV. DESIGN STANDARDS FOR ALL PROPERTIES

Awnings and Canopies	73
Street Layout	74
Outdoor Use Areas	74
Handrails and Enclosures	75
Art and Historic Properties	76
Site Lighting	76
Building Lighting	77
Service Areas	78
Surface Parking	78
Buffers	79
Building Equipment	79
Security Devices	80
Color	82
Archeological Resources	82

V. DESIGN STANDARDS FOR NEW CONSTRUCTION

Overview	85
Building Placement and Orientation	86
Architectural Character and Detail	87
Building Mass, Scale and Height	89
Building and Roof Forms	92
Entrances	93
Materials	94
Windows	95
Energy Efficiency in New Designs	97
Energy Efficiency in Building Massing	99
Environmental Performance in Building Elements	100
Solar and Wind Energy Devices	100

VI. DESIGN STANDARDS FOR SIGNS

Overview	103
Treatment of Historic Signs	104
Sign Installation on a Historic Building	105
Design of New and Modified Signs	106
Design of Specific Sign Types	107
Awning Sign	107
Interpretive Sign	107
Murals	108
Tenant Panel or Directory Sign	109
Projecting/Under-Canopy Sign	109
Flush Wall Sign	110
Window and Door Sign	111
Kiosks	112
Other Sign Types	112
Illumination	112

APPENDIX

Historic Architectural Styles	A-3
-------------------------------	-----

INTRODUCTION



Overview

Fort Collins is recognized for its rich collection of historic resources. They are enjoyed by residents, business owners and visitors as links to the city's heritage while also setting the stage for a vibrant future. Preserving these assets is essential to Fort Collins' well being.

A key collection of these historic resources is found in the Old Town Historic District which is a place with special meaning for Fort Collins. Once the core of business activity, the brick and stone facades provide a link with the past. The ornamental cornices, brackets, and lintels are records of the skilled craftsmen who worked to build Fort Collins at the turn of the century.

The community recognized the significance of the Old Town Historic District as an important cultural resource. They wished to preserve the inherent historic elements of buildings as a cultural record for future generations and to maintain the sense of place that existed. Responding to this sentiment the City Council designated the area an official locally designated historic district in 1979. Previously, in 1978, the Secretary of the Interior also entered a somewhat larger Old Town Fort Collins Historic District into the National Register of Historic Places.

The Landmark Preservation Commission and city staff have the responsibility to review the proposed changes in the area and determine their compliance with the design standards. The design standards are to be used by the Landmark Preservation Commission and city staff to review any changes to the exterior of buildings within the Old Town Historic District. They are also for designers and owners who are planning projects within the district.

Today, many of the historic resources found within the Old Town Historic District have been rehabilitated and the district is thriving. The document highlights the success stories of past projects and the positive impact they have had. While rehabilitation will continue in the district, additions and infill construction are also anticipated. The standards are intended to promote designs that respect the heritage of the area. They therefore encourage projects that contribute to the quality of the district.

The historic preservation design standards promote the community's vision for sustainable preservation. The standards also provide direction for rehabilitation, alteration, expansion and new construction projects involving locally-designated individual historic landmarks and properties in locally-designated historic districts elsewhere in Fort Collins. They also guide city staff and the Landmark Preservation Commission's evaluation of such projects, helping the city and property owners maintain the special qualities of Fort Collins' history.



Financial Assistance

See the following web site links for financial assistance programs that may be available for the rehabilitation of a historic resource:

- City of Fort Collins, Historic Preservation web site:
<http://www.fcgov.com/historicpreservation/>
- History Colorado web site to assist in rehabilitation projects:
<http://www.historycolorado.org>
- National Park Service web site for tax credit information to assist in rehabilitation projects:
<http://www.nps.gov/tps/tax-incentives.htm>

About this Document

Why Do We Preserve Historic Resources?

We preserve historic resources for these reasons:

- » To honor our diverse heritage
- » To support sound community planning and development
- » To maintain community character and support livability
- » To support economic, social and environmental sustainability in our community

Background

The *Old Town Historic District Design Standards* are an update to the *Design Guidelines for Historic Old Town Fort Collins, 1981*.

Note

In this document, “Old Town” refers to the area officially designated as the local historic district, in contrast to a more general reference to a larger portion of the downtown. See map on page 16.

WHAT ARE DESIGN STANDARDS?

Design standards are regulatory provisions that promote historic preservation best practices. They seek to manage change so the historic character of the district is respected while accommodating compatible improvements. They reflect the city’s goals to promote economic and sustainable development, enhance the image of the city and reuse historic resources.

An essential idea is to protect historic resources in the district from alteration or demolition that might damage the unique fabric created by buildings and sites that make up the Old Town Historic District.

The standards also promote key principles of urban design which focus on maintaining an attractive human-scaled pedestrian-oriented environment.

The design standards also provide a basis for making consistent decisions about the treatment of historic resources and new infill within the district. Designing a new building or addition to fit within the historic character of Old Town requires careful thought. Preservation in a historic district context does not mean that the area must be “frozen” in time, but it does mean that, when new construction occurs, it shall be in a manner that reinforces the basic visual characteristics of the historic district. In addition, the standards serve as educational and planning tools for property owners and their design professionals who seek to make improvements.

While the design standards are written for use by the layperson to plan improvements, property owners are strongly encouraged to enlist the assistance of qualified design and planning professionals, including architects and preservation consultants.

Background

POLICIES UNDERLYING THE DESIGN STANDARDS

Several regulations and policy documents establish the foundation for the standards, including:

City Plan Fort Collins, Historic Preservation

Principle LIV 16: The quality of life in Fort Collins will be enhanced by the preservation of historic resources and inclusion of heritage in the daily life and development of the community.

Policy LIV 16.1 – Survey, Identify, and Prioritize Historic Resources. Determine what historic resources are within the Growth Management Area, how significant these resources are, the nature and degree of threat to their preservation, and methods for their protection.

Policy LIV 16.2 – Increase Awareness. Increase awareness, understanding of, and appreciation for the value of historic preservation in contributing to the quality of life in Fort Collins.

Policy LIV 16.3 – Utilize Incentives. Use incentives to encourage private sector preservation and rehabilitation of historic resources.

Policy LIV 16.4 – Utilize Planning and Regulations. Recognize the contribution of historic resources to the quality of life in Fort Collins through ongoing planning efforts and enforcement regulations.

Policy LIV 16.5 – Encourage Landmark Designation. Actively encourage property owners to designate their properties as historic landmarks.

Policy LIV 16.6 – Integrate Historic Structures. Explore opportunities to incorporate existing structures of historic value into new development and redevelopment activities.

Principle LIV 17: Historically and architecturally significant buildings Downtown and throughout the community will be valued and preserved.

Policy LIV 17.1 – Preserve Historic Buildings. Preserve historically significant buildings, sites and structures throughout Downtown and the community. Ensure that new building design respects the existing historic and architectural character of the surrounding district by using compatible building materials, colors, scale, mass, and design detailing of structures.

Policy LIV 17.2 – Encourage Adaptive Reuse. In order to capture the resources and energy embodied in existing buildings, support and encourage the reuse, and adaptation of historically significant and architecturally important structures, including but not limited to Downtown buildings, historic homes, etc.

Policy LIV 17.3– Ensure Congruent Energy Efficiency. Ensure that energy efficient upgrades contribute to or do not lessen the integrity of historic structures. Consider attractive means of achieving efficiency such as installing storm windows.

Land Use Code Section 3.4.7 Historic and Cultural Resources

Section 3.4.7 provides standards for preservation and treatment of historic properties and their incorpora-

tion into new developments. It provides a good basis for design standards and guidelines as it sets the broad principles for the treatment of historic resources, but gives only very limited guidance or direction for rehabilitation of historic properties themselves.

Code of the City of Fort Collins, Chapter 14 Landmark Preservation

This section of the code sets forth the following declaration of policy for Historic Preservation within the City:

(a) It is hereby declared as a matter of public policy that the protection, enhancement and perpetuation of sites, structures, objects and districts of historical, architectural or geographic significance, located within the City, are a public necessity and are required in the interest of the prosperity, civic pride and general welfare of the people.

(b) It is the opinion of the city council that the economic, cultural and aesthetic standing of this City cannot be maintained or enhanced by disregarding the historical, architectural and geographical heritage of the City and by ignoring the destruction or defacement of such cultural assets.

It also identifies:

- › standards for determining eligibility,
- › designation procedures,
- › construction, alteration and demolition activity, and a
- › landmark rehabilitation program

THE SECRETARY OF THE INTERIOR'S STANDARDS FOR REHABILITATION

The City of Fort Collins requires rehabilitation projects to be in conformance with the *Secretary of the Interior's Standards and Guidelines for Rehabilitating Historic Buildings*.

The *Secretary of the Interior's Standards for Rehabilitation* are general standards established by the National Park Service for historic properties. It is the intent of this document to be compatible with The Secretary of the Interior's Standards while expanding on the basic rehabilitation principles as they apply in Fort Collins.

Standards for Rehabilitation:

"1. A property shall be used for its historic purpose or be placed in a new use that requires minimal change to the defining characteristics of the building and its site and environment.

2. The historic character of a property shall be retained and preserved. The removal of historic materials or alteration of features and spaces that characterize a property shall be avoided.

3. Each property shall be recognized as a physical record of its time, place, and use. Changes that create a false sense of historical development, such as adding conjectural features or architectural elements from other buildings, shall not be undertaken.

4. Most properties change over time; those changes that have acquired historic significance in their own right shall be retained and preserved.

5. Distinctive features, finishes, materials and construction techniques or examples of craftsmanship that characterize a historic property shall be preserved.

6. Deteriorated historic features shall be repaired rather than replaced. Where the severity of deterioration requires replacement of a distinctive feature, the new feature shall match the old in design, color, texture, and other visual qualities and, where feasible, materials. Replacement of missing features shall be substantiated by documentary, physical, or pictorial evidence.

7. Chemical or physical treatments, such as sandblasting, that cause damage to historic materials shall not be used. The surface cleaning of structures, if appropriate, shall be undertaken using the gentlest means possible.

8. Archeological resources affected by a project shall be protected and preserved. If such resources must be disturbed, mitigation measures shall be undertaken.

9. New additions, exterior alterations, or related new construction shall not destroy historic materials, features and spatial relationships that characterize the property. The new work shall be differentiated from the old and shall be compatible with the historic materials massing, size, scale, and architectural features to protect the historic integrity of the property and its environment.

10. New additions and adjacent or related new construction shall be undertaken in such a manner that if removed in the future, the essential form and integrity of the historic property and its environment would be unimpaired."

PRESERVATION BRIEFS & TECH NOTES

The Cultural Resources Department of the National Park Service, U.S. Department of the Interior, publishes a series of technical reports regarding proper preservation techniques. This series, *Preservation Briefs and Tech Notes*, is a mainstay for many preservationists in the field. When considering a preservation project, these resources should be consulted.

For More Information

For more information on national treatments underlying the preservation standards, see *The Secretary of the Interior's Standards for Rehabilitation*:

http://www.nps.gov/history/hps/tps/standguide/rehab/rehab_index.htm

For More Information:

See the following web links to National Park Service *Preservation Briefs and Tech Notes*:

<http://www.nps.gov/tps/how-to-preserve/briefs.htm>

<http://www.nps.gov/tps/how-to-preserve/tech-notes.htm>

Historic Preservation and Sustainability

SUSTAINABILITY - SOCIAL, ECONOMIC AND ENVIRONMENTAL BENEFITS OF HISTORIC PRESERVATION

Preserving and enhancing historic places promotes the three basic components of sustainability. These are: (1) Cultural/Social Sustainability, (2) Environmental Sustainability and (3) Economic Sustainability. Each of the components is described in greater detail in the following pages.



Preserving historic places promotes the three basic categories of sustainability.

Cultural/Social Component of Sustainability

This component relates to the maintenance of the community's cultural traditions and social fabric. Preserving historic places and patterns promotes cultural and social sustainability by supporting everyday connections between residents and the cultural heritage of the community. These connections are reinforced by the physical characteristics of historic places, which often directly support environmental sustainability.

Historic properties in the district provide direct links to the past. These links convey information about earlier ways of life that help build an ongoing sense of identity within the community. Residents anchored in this sense of identity may be more involved in civic activities and overall community sustainability efforts.

The historic development pattern of the district promotes social interaction that supports a high quality of life and helps build a sense of community. The area is compact and walkable, providing for impromptu mixing of different cultural and economic groups. Direct connections to the public realm provide opportunities for community interaction. This physical pattern, combined with the inherent cultural connections, provides significant support for the community's overall sustainability effort.

Environmental Component of Sustainability

This is the most often cited component of sustainability. It relates to maintenance of the natural environment and the systems that support human development. Rehabilitation of historic resources is an important part of environmental sustainability and green building initiatives. It directly supports environmental sustainability through conservation of embodied energy, adaptability, and other factors that keep historic buildings in use over long periods of time.

Inherent Energy

Typically historic buildings were built with energy efficiency in mind. Construction methods focused on durability and maintenance, resulting in individual building features that can be repaired if damaged, thus minimizing the need for replacement materials. Buildings were also built to respond to local climate conditions, integrating passive and active strategies for year-round interior climate control, which further increase energy efficiency. Passive strategies typically include building orientation for sun and breezes. Active strategies typically include operable awnings, and double-hung and transom windows.

Embodied Energy

Embodied energy is defined as the amount of energy used to create and maintain the original building and its components. Preserving a historic structure retains this energy. Re-using a building also preserves the energy and resources invested in its construction, and reduces the need for producing new construction materials, which require more energy to produce. Studies confirm that the loss of embodied energy by demoli-

Historic Preservation and Sustainability

By preserving existing buildings and guiding compatible redevelopment, the *Design Standards* promote the three key elements of community sustainability:

- » **Cultural/Social Sustainability.** Preserving historic places and patterns promotes cultural and social sustainability by supporting everyday connections between residents and the cultural heritage of the community. It also enhances livability in the community.
- » **Environmental Sustainability.** Rehabilitation of historic resources conserves energy that is embodied in the construction of existing structures. It also reduces impacts on landfill from demolition and reduces the need to fabricate new materials.
- » **Economic Sustainability.** The economic benefits of protecting historic resources include higher property values, job creation and increased heritage tourism.

For More Information:

See web link to National Park Service Sustainability information:

<http://www.nps.gov/tps/sustainability.htm>

tion takes three decades or more to recoup, even with the reduced operating energy costs in a replacement building.

Building Materials

Many of the historic building materials used in the district contribute to environmental sustainability through local sourcing and long life cycles. Buildings constructed with wood and masonry were built for longevity and ongoing repair. Today, new structures utilize a significant percentage of manufactured materials. These materials are often less sustainable and require extraction of raw, non-renewable materials. High levels of energy are involved in production, and the new materials may also have an inherently short lifespan.

The sustainable nature of historic building materials is best illustrated by a window: older windows were built with well seasoned wood from durable, weather resistant old growth forests. A historic window can be repaired by re-glazing as well as patching and splicing the wood elements. Many contemporary windows cannot be repaired and must be replaced entirely. Repairing, weather-stripping and insulating an original window is generally as energy efficient and much less expensive than replacement.

Landfill Impacts

According to the Environmental Protection Agency, building debris constitutes around a third of all waste generated in the country. The amount of waste is reduced significantly when historic structures are retained rather than demolished.

Economic Component of Sustainability

This component of sustainability relates to the economic balance and health of the community. The economic benefits of protecting historic resources are well documented across the nation. These include higher property values, job creation in rehabilitation industries, and increased heritage tourism. Quality of life improvements associated with living in historic districts may also help communities recruit desirable businesses.

Historic Rehabilitation Projects

Historic rehabilitation projects generate both direct and indirect economic benefits. Direct benefits result from the actual purchases of labor and materials, while material manufacture and transport results in indirect benefits. Preservation projects are generally more labor intensive, with up to 70% of the total project budget being spent on labor, as opposed to 50% when compared to new construction. Expenditure on local labor and materials benefits the community's economy.

For More Information:

See the following web link to *Preservation Brief 3: Improving Energy Efficiency in Historic Buildings*:

<http://www.nps.gov/tps/how-to-preserve/briefs/3-improve-energy-efficiency.htm>

The Development of Old Town Fort Collins

HISTORY

The opening of the Overland Stage Line between Denver and Wyoming, in the early 1860s, necessitated the construction of military forts to protect coaches and immigrant trains from the threat of Indian attacks. Entering the Cache La Poudre River Valley in 1862, the 9th Kansas Volunteer Cavalry set up camp in the vicinity of Laporte, Colorado. In 1864, due to severe flooding of the Cache La Poudre and a series of military command changes, the outpost, known as Camp Collins, was moved to the area just southeast of the old Fort Collins Power Plant.

The founding of the military post attracted citizens wishing to open mercantile establishments and thereby capitalize on trading with the nearby soldiers. Joseph Mason was the first to obtain permission from the War Department to build a store on the four-mile-square military reservation. His structure was erected in 1865 on land that later became the Linden/Jefferson intersection. Called “Old Grout,” it served as a settler’s store, church, post office, community center, and later as the county offices and courthouse. Old Town claims the site as the foundation for the City of Fort Collins. Two other notable structures built in the area include Auntie Stone’s cabin/hotel and a flour mill.

The establishment of this commercial district necessitated the platting of the town’s first streets. In 1867-1868, Jack Dow and Norman H. Meldrum surveyed the area and set up streets that ran parallel to the major

environmental landmark, the Cache La Poudre River. However, the influx of proprietors to Fort Collins, and specifically the Old Town area, was certainly not a stampede because when the fort closed in 1866, there were scarcely a dozen civilians in town. The subsequent departure of the soldiers put the town’s future in question. The town and its business district languished until the mid-1870s.

In retrospect, the prosperity of the town was assured in an incident, called by Ansel Watrous in his History of Larimer County, “perhaps the most notable event in the early history of Fort Collins.” In the fall of 1872 the agricultural colony was established.

General R. A. Cameron, originator of the Union Colony in Greeley, spearheaded the drive for Fort Collins’s Agricultural Colony. The purpose of the new commune was for it to be the crop-raising group for the settlers at the Union Colony. Working with the earlier settlers of Fort Collins, the officers of the new colony organized the Larimer County Land Improvement Company. The goal of the company was to encourage settlement of the Fort Collins area. Within two months of their arrival, the company had acquired enough land for their surveyor to come in and plat new city streets. For this job they chose a young New Yorker, Franklin C. Avery, who had also platted the Union Colony. Mr. Avery, utilizing the latest techniques in city planning, laid the streets according to the cardinal points of the

compass, rather than along the environmental dictates that guided Dow and Meldrum. By including most of the original surveyed area of Fort Collins, Avery created the distinct triangular shaped lots and streets that characterize Old Town.

Spring of 1873 saw an influx of population, and many new business buildings were erected in Old Town. During that year 68 frame buildings were constructed in Fort Collins, with a majority in the Old Town area, but gusty autumn winds blew several down. The ones that remained were later removed to build the more sturdy brick buildings that stand today. Near harvest time of the same year a plague of grasshoppers descended upon the crops and devoured them. The businesses of the community suffered along with the farmers, as the grasshoppers made repeat performances in 1874 and 1875. Many families and businesses in Old Town left, Ansel Watrous wrote, “Building was practically at a standstill and business of all kinds was in the dumps.”

The arrival of the Colorado Central Railroad in 1877 began a new era of prosperity for Fort Collins, and in particular for Old Town, as the Terminal was in close proximity to the business district. Investments in housing and business buildings rose, as did the spirit of the people who lived and worked in Old Town. The following year saw the building of some substantial brick business blocks in Old Town, and a promise of more to come.

The decades of the 1880s and nineties saw the addition of ornately decorated buildings like the Miller Block and the Linden Hotel. Other distinctive buildings, like the City Hall /Fire Station, added uniqueness to this area. In 1887 electric lights and the town's first telephone enhanced Old Town's status as the mercantile center for Fort Collins. In 1897 the Avery Building provided the link between Old Town and New Town. An early competition developed between the business people in Old Town and those with businesses near the intersection of College and Mountain. The new Avery Building was a bridge that joined these two shopping areas together. But the competition between the two areas was to remain strong throughout the next century.



Miller Block (1889)

The new century, however, brought other problems to Old Town. The Post Office, with its accompanying pedestrian traffic and long an institution in one building or another in the triangle, moved to the corner of Oak and College. Mr. Avery crossed Mountain Avenue to



1889 Bird's Eye view of Old Town



Old Town (1900)



Linden Hotel (1908)

build yet another structure for his rapidly expanding First National Bank.

By the 1900s Fort Collins was the well-settled home of Colorado's first land-grant college, the possessor of a notable in-town railway transit system, and a very popular spot in northern Colorado for urbanite and farmer alike. On the direct railroad line between Denver and Cheyenne, the passenger depot on Jefferson Street in Old Town welcomed contented old-timers of the community and diverse newcomers: academic, agricultural, and financial. Fort Collins' residents were served well by Old Town, whose offerings ranged from commodities and services found in eastern cities to items more commonly located in agricultural communities. These ranged from hotel accommodations, banks and restaurants to hardware stores, feed, coal and hay shops.

The major retail businesses left the interior of the triangle to locate along College Avenue frontage in the early 1920s in response to the advent of an auto-oriented population. Other, smaller businesses soon thought it was more advantageous to move along College Avenue.

After World War II the area was beginning to show signs of aging and decay. During the 1950s and 1960s, Old Town became home to social services organizations, automobile maintenance facilities, and some limited retail. It also housed a collection of taverns and some low-cost housing.

Revitalization began in the 1980s, with individual investors who saw opportunities in rehabilitating the historic structures in the area. The Secretary of the Interior listed the Old Town Historic District in the National Register in 1978. This included all of the land area that was later (1979) designated as the local historic district,



To preserve the historic building fabric and to provide dining, retail and entertainment uses was a goal of the 1985 redevelopment plan.



Illustrative plan from the 1985 redevelopment plan set a vision for Old Town.

but also extended farther north to include the original fort site. This made federal income tax credits available for the certified rehabilitation of historic structures in the area. With the city's designation of the local historic district in 1979, a formal design review process was established to assure that historic buildings would be preserved and that new construction would be compatible with the historic context.

Individual investment efforts attracted more investment, and in 1985 Old Town Associates proposed a redevelopment plan that included rehabilitation of several historic buildings, erection of new infill buildings and construction of a pedestrian area for a portion of Linden Street. Revitalization continued through the turn of the twenty-first century, with substantial participation of the City of Fort Collins and the Downtown Development Authority. By 2013, the Old Town Historic District was well-established as a center for

dining, retail and entertainment as well as housing and professional offices.

Fort Collins' Old Town is a reminder of its early pioneer settlement. It was established by people who purchased lands from a real estate company in order to ward off the loneliness of the prairies, to profit by the experience and expertise of their new neighbors, and to furnish their families with social amenities that were long in coming to communities situated farther east on the Great Plains. Old Town demonstrates how these people settled a new area and used local materials to decorate it with styles current in the East, creating a substantial, as well as unique, latter nineteenth-century American community.

Historic Development Patterns

Old Town retains many framework elements from its early history; other features have changed over time. The fact that it has remained dynamic is a part of its heritage. For this reason, remaining resources which help to interpret that span of human occupation and use are valued.

While a row of historic buildings may be easily understood as defining a particular span of time, other features are more subtle but still continue to influence patterns of development.

The aerial image shown on the next page underscores the value of the features that still survive because they provide a hint to the early character.

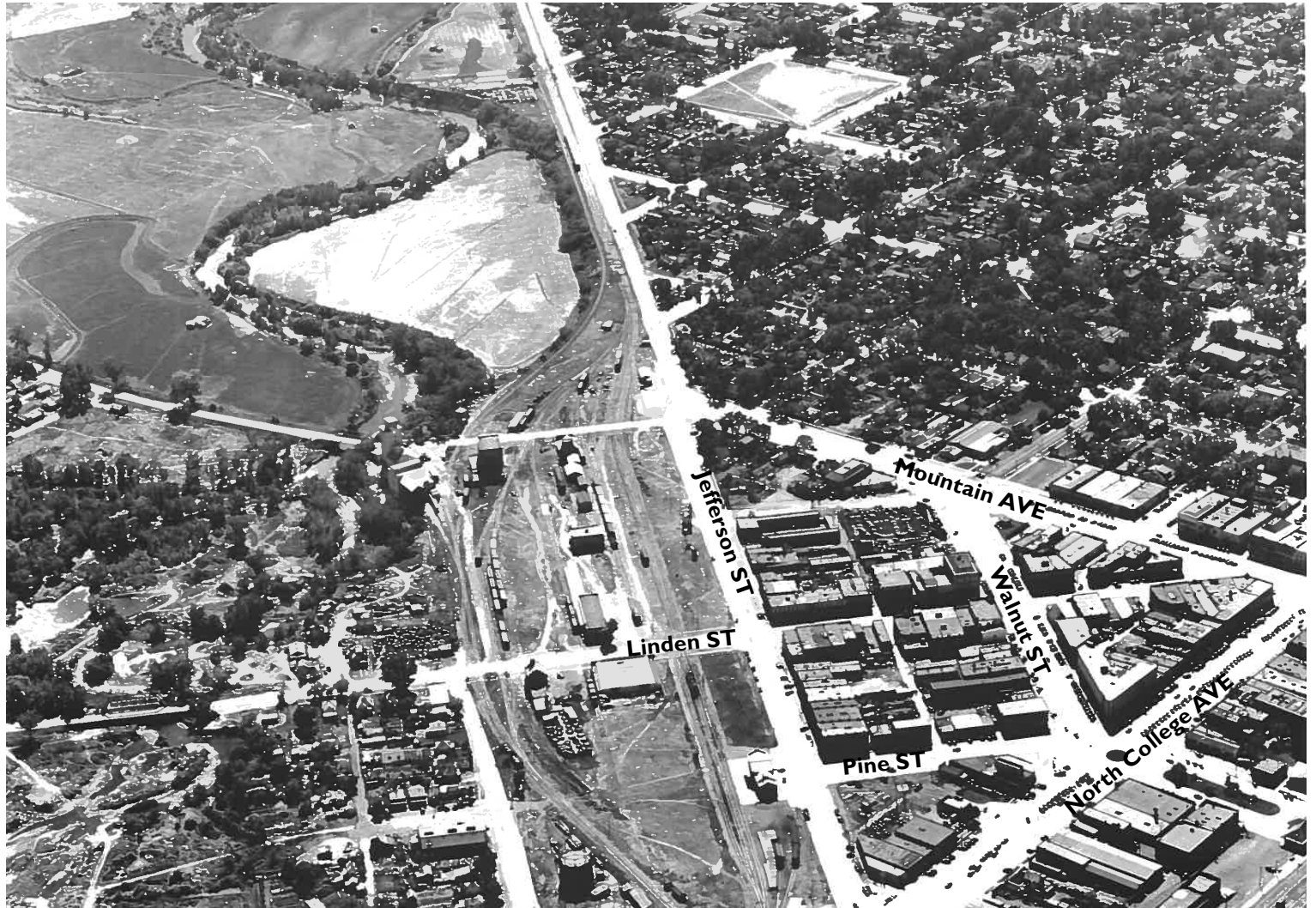

Circa 1920's image of Old Town Fort Collins Historic District. Streets that run at an angle to the standard grid pattern of the rest of town give the Old Town Historic District a distinct triangular shape that is clearly visible. The River District is visible in this image as well. (Aerial image looking south east.)

I
USING THE DESIGN STANDARDS



Design Review System

The Landmarks Preservation Commission and City staff shall take these factors into consideration when reviewing proposed work:

- › The significance of the property
- › The context, with respect to other historic properties
- › The location of any key, character-defining features
- › The condition of those features
- › The landmark status
- › Eligibility status of the property

In addition, there are many cases in which the standards state that one particular solution is preferred, such as for the replacement of a damaged or missing feature, but the text further notes that some alternatives may be considered if the preferred approach is not feasible. In determining such feasibility, the city will also consider:

- › The reasonable availability of the preferred material
- › The skill required to execute the preferred approach
- › The quality, appearance and character of alternative solutions, such as new materials.

TERMS RELATED TO COMPLIANCE

When applying design standards, the City has the ability to balance a combination of objectives and intent statements that appear throughout the document, in the interest of helping to achieve the most appropriate design for each project. Because of this, and the fact that the design standards are also written to serve an educational role as well as a regulatory one, the language sometimes appears more conversational than that in the body of the City Code. To clarify how some terms are used, these definitions shall apply:

Standard

In this document the term “standard” is a criterion with which the City will require compliance when it is found applicable to the specific land-use activity.

Shall

Where the term “shall” is used, compliance is specifically required, when the statement is applicable to the proposed project.

Where the Design Standards Apply

The design standards apply to all properties within the Old Town Historic District. They also apply as guidelines to eligible and designated properties within the River Downtown Redevelopment Zone District. These areas and properties are identified on the map below.



Design Standards Organization

DESIGN REVIEW TRACKS

The design standards chapters are grouped into three “tracks” for purposes of design review. Staff will determine which track a project will follow. (See the chart on the following page.) These are:

- › Preservation Track
- › New Building Track
- › Other Improvements Track

Follow these steps to get started:

Step 1 What Type of Improvement?

Determine the nature of the improvements that are planned. There are three categories:

Existing Building

If improvements are planned to an existing building, determine if it has historic significance or not. This will influence which review track applies.

New Building

Will the planned improvements include construction of a new building? If so, then the “New Construction Track” applies. This includes a new structure to be erected on a vacant lot; adding a new structure to a lot with an existing building on it; or providing an addition to an existing noncontributing building where one already exists.

Other Work

Site improvements, signs and other miscellaneous projects follow this third track.

Step 2 What Type of Existing Building?

All existing structures in the Old Town Historic District are classified with respect to their historic significance, using criteria established by the National Park Service. The City will work with the property owner to confirm the status of historic significance. Two classifications are used:

Contributing Property

A “contributing” property is one determined to be historically significant. It is so because it was present during the period of significance and possesses sufficient integrity to convey its history, or is capable of yielding important information about that period.

Note that some properties may have experienced some degree of alteration from their historic designs. These alterations may include window replacement, cornice removal, a porch enclosure or covering of a building’s historic materials. Nonetheless, these altered properties retain sufficient building fabric to still be considered contributors. For all contributing properties, the Preservation Track shall apply.

Noncontributing Property

The classification of “noncontributing” applies to existing buildings that do not possess sufficient significance and/or exterior integrity necessary for designation, and are considered noncontributing to a district. The New Construction Track applies to these properties, except as noted below.

Noncontributing, but Restorable

In some cases, an older noncontributing property which has been substantially altered could be restored with a sufficient degree of care, such that it may be re-classified as a contributing property once improvements are completed. An owner may elect to take such an approach; the city will work with the owner to determine if this is appropriate. For this special condition, the Preservation Track will apply. This option is not mandatory and is up to the building owner.

WHICH TRACK APPLIES?

The standards are organized into groups of chapters that represent “tracks” for different types of improvements. This chart defines the track that will apply to a specific proposal.

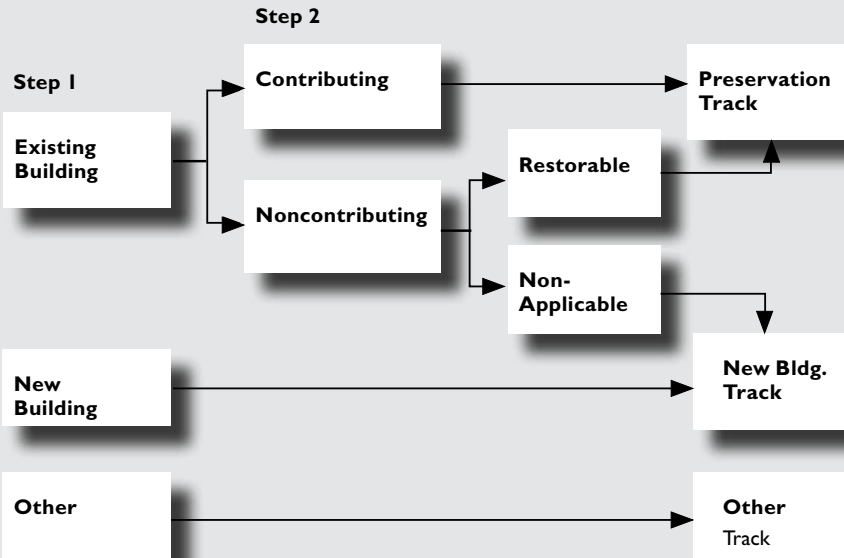

WHICH CHAPTERS APPLY?

Use this chart to determine which chapters of the design standards apply to a proposed improvement project. Some projects will include work in more than one track; in this case a combination of chapters will apply.

TYPE OF WORK		SECTION TO USE:						
		Introduction	I. Using the Design Standards	II. Planning a Preservation Project	III. Design Standards for the Treatment of Historic Resources	IV. Design Standards for All Properties	V. Design Standards for New Construction	VI. Design Standards for Signs
Preservation Track	Rehabilitate a contributing property	✓	✓	✓	✓	✓	(I)	(I)
	Restore a noncontributing property	✓	✓	✓	✓	✓	(I)	(I)
New Building Track	Improve a noncontributing property	✓	✓			✓	✓	(I)
	Construct a new building	✓	✓			✓	✓	(I)
Other Track	Signs	✓	✓	(I)	(I)		(I)	✓
	Site Work	✓	✓	(I)	(I)	(I)	✓	
	Miscellaneous	✓	✓			✓		

(I) Standards may apply to some projects in this category.

DESIGN STANDARDS FORMAT

The historic preservation standards are presented in a standardized format as illustrated below.

A → Windows

Historic windows help convey the significance of historic structures, and shall be preserved. They can be repaired by re-glazing and patching and splicing elements such as muntins, the frame, sill and casing. Repair and weatherization also is more energy efficient, and less expensive than replacement. If an original window cannot be repaired, new replacement windows shall be in character with the historic building.

B →

C → I.1 Maintain and repair historic windows.

» Preserve historic window features including the frame, sash, muntins, mullions, glazing, sills, heads, jambs, moldings, operation and groupings of windows.

D →

- » Repair and maintain windows regularly, including trim, glazing putty and glass panes.
- » Repair, rather than replace, frames and sashes.
- » Restore altered window openings to their historic configuration.

E →



Key

A Design Topic Heading

B Intent Statement: This explains the desired outcome for the specific design element and provides a basis for the design standards that follow.

C Design Standard: This describes a desired outcome related to the intent statement.

D Additional Information: This provides a bullet list of examples of how, or how not to, comply with the standard.

E Illustration(s): These provide photos and/or diagrams to illustrate related conditions or possible approaches. They may illustrate permitted or prohibited solutions as described at right.

Sidebars

These provide additional information that will be helpful in understanding the standard. In some cases a sidebar includes links that direct the user to additional material; this may be technical information about a rehabilitation procedure or other helpful information.

Permitted and Prohibited Solutions

In many cases, images and diagrams in the historic preservation standards are marked to indicate whether they represent permitted or prohibited solutions



A check mark indicates permitted solutions.



An X mark indicates solutions that are prohibited.



II

PLANNING A PRESERVATION PROJECT

What Does Historic Preservation Mean?

Historic preservation means keeping historic properties and places in active use while accommodating appropriate improvements to sustain their viability and character. It also means keeping historic resources for the benefit of future generations. That is, while maintaining properties in active use is the immediate objective, this is in part a means of assuring that these resources will be available for others to enjoy in the future.

Historic preservation does not mean necessarily freezing properties or districts in time. Historic preservation seeks to manage change to preserve authenticity and historic craftsmanship while adapting to existing and future needs.

This section summarizes important steps and approaches to consider when planning a preservation project

- › Planning a Preservation Project
- › Case Studies
- › Designing in Context
- › Historic Building Styles

When planning a preservation project, it is important to determine historic significance, assess integrity and determine program requirements prior to outlining a treatment strategy that will inform the overall project scope.

ACCEPTED TREATMENTS FOR HISTORIC RESOURCES

The following list describes permitted treatments for historic resources that may be considered when planning a preservation project. Much of the language addresses buildings; however, sites, objects and structures are also relevant.

Preservation

“Preservation” is the act of applying measures to sustain the existing form, integrity and material of a building. Work focuses on keeping a property in good working condition with proactive maintenance. While the term “preservation” is used broadly to mean keeping a historic property’s significant features, it is also used in this more specific, technical form in this document.

Restoration

“Restoration” is the act or process of accurately depicting the form, features and character of a property as it appeared in a particular time period. Features from later periods must be removed for an accurate restoration and to use the Restoration Treatment. This may apply to an entire building, or to restoring a particular missing feature.

Reconstruction

“Reconstruction” is the act or process of depicting, by means of new construction, the form, features and detailing of a non-surviving site, landscape, building, structure or object for the purpose of replicating its appearance at a specific time and in its historic location. This has limited application, in terms of an entire building, but may apply to a missing feature on a building.

Rehabilitation

“Rehabilitation” is the process of returning a property to a state that makes a contemporary use possible while still preserving those portions or features of the property which are significant to its historical, architectural and cultural values. Rehabilitation may include a change in use of the building or the construction of an addition. This term is the broadest of the permitted treatments and applies to most work on historic properties.

Combining Treatments

For many projects a “rehabilitation” approach will be the overall strategy, because this term reflects the broadest, most flexible of the approaches. Within that, however, there may be a combination of treatments used as they relate to specific building components. For example, a surviving cornice may be preserved, a storefront base that has been altered may be restored, and a missing kickplate may be reconstructed.

Planning a Preservation Project

A successful preservation project shall consider the significance of the historic resources, its key features, and the project's program requirements. The tables and diagrams presented here and on the following pages provide overall guidance for planning a preservation project.

STEPS TO CONSIDER FOR A SUCCESSFUL PRESERVATION PROJECT.

Follow the steps below when planning a preservation project.

Step 1. Review reasons for significance: The reasons for significance will influence the degree of rigor with which the standards are applied, because it affects which features will be determined to be key to preserve. Identifying the building's period of significance is an important first step.



Step 2. Identify key features: A historic property has integrity. It has a sufficient percentage of key character-defining features and characteristics from its period of significance which remain intact.



Step 3. Identify program requirements for the desired project: The functional requirements for the property drive the work to be considered. If the existing use will be maintained, then preservation will be the focus. If changes in use are planned, then some degree of compatible alterations may be needed.

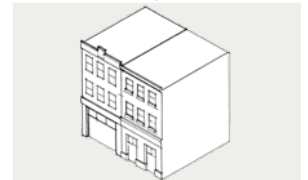

Step 4. Implement a treatment strategy: A permitted treatment strategy will emerge once historic significance, integrity and program requirements have been determined. A preservation project may include a range of activities, such as maintenance of existing historic elements, repair of deteriorated materials, the replacement of missing features and construction of a new addition.

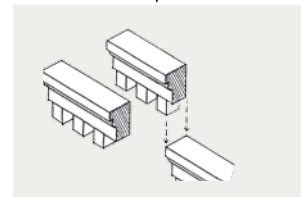

PREFERRED SEQUENCE OF ACTIONS

Selecting an appropriate treatment for a character-defining feature is important. The method that requires the least intervention is always preferred. By following this tenet, the highest degree of integrity will be maintained. The following treatment options appear in order of preference. When making a selection, follow this sequence:

Step 1. Preserve: If a feature is intact and in good condition, maintain it as such.



Step 2. Repair: If the feature is deteriorated or damaged, repair it to its historic condition.



Step 3. Replace: If it is not feasible to repair the feature, then replace it in kind, (e.g., materials, detail, finish). Replace only that portion which is beyond repair.



Step 4. Reconstruct: If the feature is missing entirely, reconstruct it from appropriate evidence. If a portion of a feature is missing, it can also be reconstructed.



Step 5. Compatible Alterations: If a new feature (one that did not exist previously) or an addition is necessary, design it in such a way as to minimize the impact on historic features. It is also important to distinguish a new feature on a historic building from the historic features, in subtle ways.

For More Information

For more information regarding the treatments for a historic resource please visit the National Park Service web site:

<http://www.nps.gov/history/hps/tps/standguide/index.htm>



If a feature is deteriorated or damaged, repair it to its historic condition.

WHICH AREAS ARE THE MOST SENSITIVE TO PRESERVE?

For most historic resources in the Old Town Historic District, the front wall is the most important to preserve intact. Alterations are rarely permitted. Many side walls are also important to preserve where they are highly visible from the street. By contrast, portions of a side wall not as visible may be less sensitive to change. The rear wall is sometimes the least important (excepting free-standing landmarks, those along improved alleys or certain civic and industrial buildings), and alterations can occur more easily without causing negative effects to the historic significance of the property.

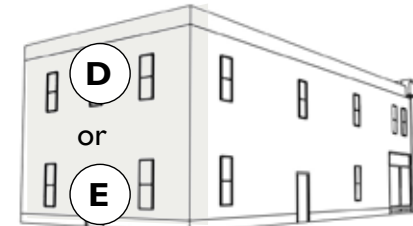
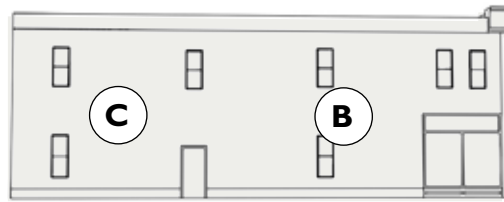
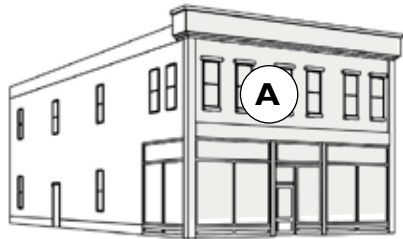

Location A. Primary Façade: Preservation and repair of features in place is the priority. This is especially important at the street level and in locations where the feature is highly visible.

Location B. Secondary Wall, Which Is Highly Visible: Some flexibility in treatment may be considered with a compatible replacement or alteration.

Location C. Secondary Wall, Which Is Not Highly Visible: Preservation is still preferred; however, a compatible replacement or alteration may be acceptable when it is not visible to the public. More flexibility in treatment may be considered.

Location D. Highly Visible Rear Wall: This applies to many cultural buildings of historic significance, such as civic buildings, improved alleys and other landmarks that are viewed “in the round” or border a public space such as a park. Preservation and repair in place is the priority.

Location E. Rear Wall That Is Not Highly Visible: A compatible replacement or alteration may be acceptable when it is not visible to the public. A higher level of flexibility in treatment may be considered.

DEVELOPING A PRESERVATION STRATEGY

The standards discuss a range of preservation options, including reconstruction and replacement of features in various ways. When applied to a building that is already altered, which would be the best approach? This diagram outlines the approaches to consider in making that decision.

ALTERED HISTORIC COMMERCIAL FACADE

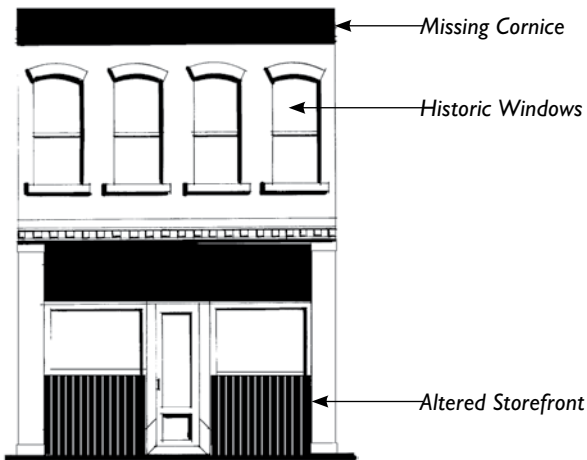

The starting condition.

Approach 1:

Accurate Restoration



When should I use this treatment?

- » The building is highly significant.
- » There is good historical information about the design.
- » The needed materials and craftsmen are available.
- » The context has many intact historic buildings.
- » To receive the most financial assistance.

Approach 2:

Rehabilitation (simplified historic interpretation)



When should I use this treatment?

- » The building is part of the fabric of the district.
- » There is less information available about the historic design.
- » A phased project is planned.
- » To receive some financial assistance.

Approach 3:

Rehabilitation (contemporary interpretation)



When should I use this treatment?

- » There is substantial alteration, making other options difficult.
- » There is less information about the historic design.
- » The context (the block lacks a substantial number of historic structures that retain integrity) has more variety.
- » Financial assistance is not a priority.

BEALS & REED BLOCK Address: 160 North College Avenue



Historic building remodel.



Interim improvements to the building included removing the canopy, providing a new sign and painting the stucco covering.

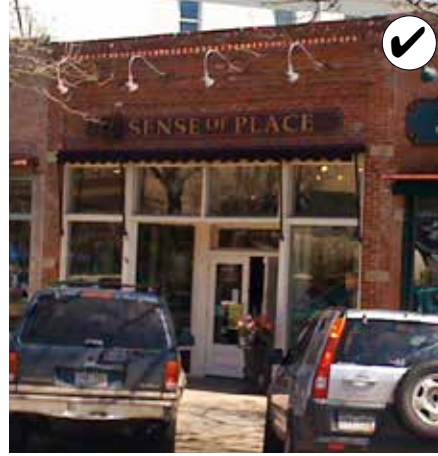

A later rehabilitation effort included removing the stucco, reconstructing the cornice and installing a new storefront system.

PHASING PRESERVATION PROJECTS

In some cases, a property owner may wish to make interim improvements, rather than execute a complete rehabilitation of a historic property. This work shall be planned such that it establishes a foundation for future improvements that will further assure continued use of the property and retain its historic significance. For example, a simplified cornice element may be installed on a commercial storefront, in lieu of reconstructing the historic design, with the intent that an accurate reconstruction would occur later.

Plan interim improvements to retain opportunities for future rehabilitation work that will enhance the integrity of a historic property.

- › Preserve key character-defining features while making interim improvements.
- › Interim improvements that would foreclose opportunities for more extensive rehabilitation in the future are not permitted.

Case Studies

CASE STUDIES

Numerous rehabilitation projects have been successfully completed since the adoption of the design standards. Some examples appear in this section. They include “before and after” pairings. Some of these include photographs from the early years when this was the center of commerce. Then, images from the 1970s and 1980s document interim conditions, when many buildings had been altered. Finally, more recent photographs, generally from 2013, illustrate the progressive rehabilitation and continuing revitalization of the area.

These case studies demonstrate the benefits of the on-going stewardship of the historic resources in the district, and of the positive effects that local historic district designation has had. They further demonstrate successful solutions for many of the design topics addressed in this standards document.

WALNUT STREET BLOCK Address: 200 block of Walnut Street, north side



In the upper photos (ca. 1981), storefronts have been altered, upper story windows have been reduced in size and new materials obscure historic masonry.

In the lower photo, windows and storefronts are restored, and historic brick facades are revealed.

EVERY BLOCK Address: 100 block of North College, 100 block of Linden Street

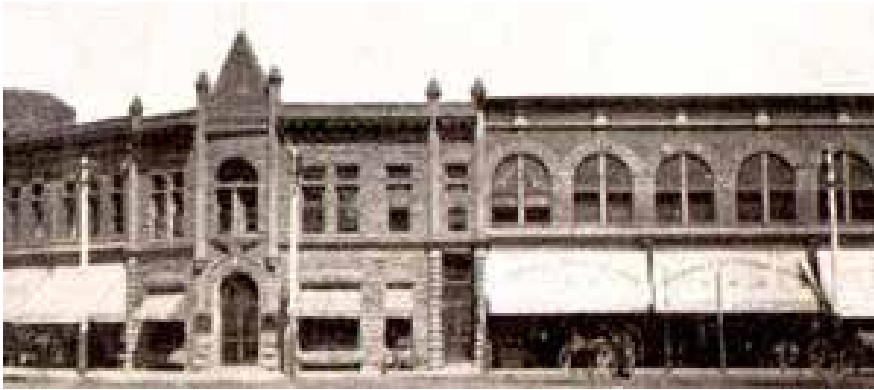

An early image of the Avery Block exhibits a distinctive line of ground level storefronts.



In 1981, storefronts had been altered, and the distinctive mid-belt cornice line was obscured.



In 2013, a reconstructed cornice reestablished a distinctive horizontal feature, and awning once more reflect the dimensions of each storefront bay.

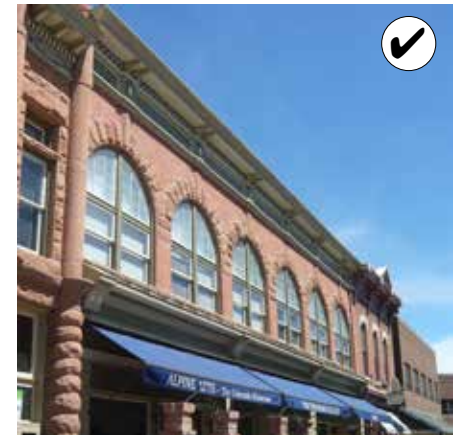
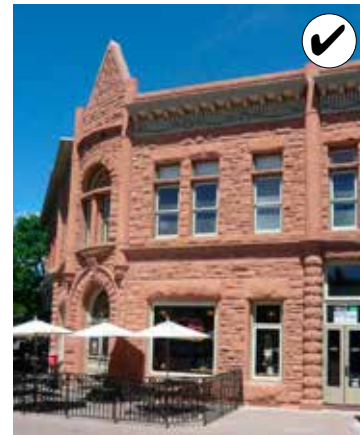

ANTLERS BLOCK Address: 200 block of Linden Street, east side



An early view of the Antlers hotel and associated buildings in its block demonstrates a variety in building heights, but a sense of continuity is established by the horizontal alignment of storefront level moldings and second story cornices.



In 1981, many historic features remain, but minor alterations have occurred, and some details are obscured by monochromatic paint schemes.



One of the buildings has been rehabilitated in this image and modifications have occurred on other buildings.



After rehabilitation (photo: 2013), buildings have been adapted to new uses while the key, character-defining features that contribute to their historic significance have been preserved.

LINDEN STREET Address: 200 block of Linden Street, west side



The northern end of the Linden Street block in 1980 appears with several storefronts missing, and a monochromatic paint scheme diminishes one's perception of the distinctive architectural details.



After rehabilitation in the mid-1980s, many storefronts have been reconstructed. Architectural details are highlighted with contrasting color schemes. The left-most storefront remains altered, but other features on this facade have been preserved.



In 2013, awnings and signs have been added, and color schemes have changed. This demonstrates the ongoing adaptive use of these properties, while preserving their historic significance.



A close-up view of the storefront at 252 Linden, in 1980 shows the missing storefront.

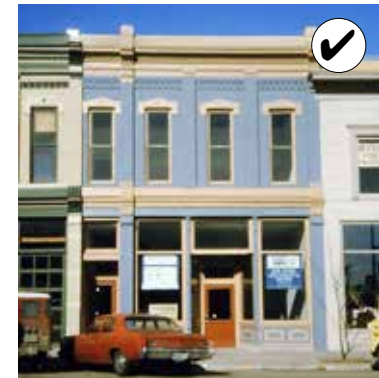

In the mid-1980s, after the storefront has been reconstructed.

THE MCPHERSON BLOCK Address: 100 block of Linden Street, west side



Ca. 1980, Black's Glass, with a missing mid-belt molding, and historic storefront altered. The transom also is covered, changing the proportions of the ground level.



In 2013, storefronts and the mid-belt molding are reconstructed.

OLD FIRE STATION AND CITY HALL Address: 200 block Walnut Street, north side



The old city hall and fire station occupied two buildings side-by-side on Walnut Street. A distinctive arch identified the door for fire engines.

Lower left:
Shortly after rehabilitation, reconstructed cornices and storefront are visible. A more contemporary storefront, using dark metal components, is used in the historic fire engine entry, to signify that this is a later alteration. The tower also is reconstructed.

Lower right:
In 2012, awnings and signs have changed, but the key features of the building remain intact, demonstrating the continuing use of this historic resource.



In 1980, the two buildings appear as one metal clad facade. The storefront for city hall has been removed, and the doorway for fire engines has been widened.



At the beginning of rehabilitation in the early 1980s, damage to the historic masonry is visible. The hose tower also is missing.



J.L.HOHNSTEIN BLOCK Address: 220 East Mountain Avenue



An early view of the Hohnstein block documents the tall first floor and the distinctive masonry arch details on the upper floor.



In 1980, metal cladding obscures most of the key character-defining features of the building front.

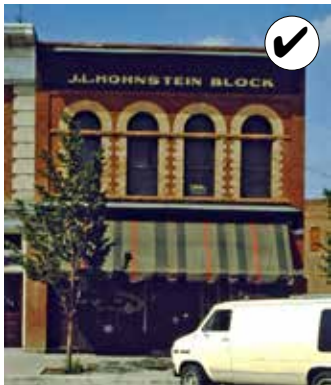

In the early 1980s, the initial rehabilitation revealed key features of the facade.



Almost 30 years later, in 2013, the building continues to be in active service. An outdoor dining area reflects a new use, but is designed to remain visually subordinate to the historic building. Note the historic sign on the side wall.

MILLER BLOCK Address: 11 Old Town Square



In this early photo, the Miller building stands as a signature building at Linden and Walnut streets; diagonally from the Linden Hotel.



In 1979, wood paneling obscures historic storefronts.



Shortly after construction of the plaza in Old Town Square, (ca. 1985), new awnings define the dimensions of individual storefront bays.



In 2013, key features remain preserved. Different awning colors distinguish individual businesses while retaining the overall visual continuity of the building.

THE LINDEN HOTEL Address: 201 Linden Street



In this early photo, the Linden Hotel stands as the signature building at the corner of Linden and Walnut Streets



In 1980s, historic masonry is covered with a cementitious plaster and the storefronts have been altered. Some upper story windows have been blocked up.



Again in the early 1980s, the Linden in an altered state. The Salvation Army and Reed and Dauth buildings are to the right.



In 2013, the Linden is once more the icon for Old Town Fort Collins.

Designing in Context

District-wide



A fundamental principle of the design standards is that projects shall be planned to be compatible with the context. This is especially relevant to the design of an addition or new building.

Levels of Context Consideration

Context shall be considered at these levels:

- › District-wide – in terms of the qualitative features, such as the orientation of the street, alley, street wall, buildings and features
- › The block – which focuses on the collection of buildings, sites and structures in the area
- › Immediate surroundings – properties adjacent to, facing or overlooking a specific site

Note: The contexts are highlighted in white and the mock project area is identified with a heavy black line.

Block



Immediate Surroundings



Historic Architectural Styles

The Architectural Style descriptions will assist the City in determining which features are key to a property's significance. Note that styles are rarely "pure" in form, and a wide range exists within individual styles. Please see the Appendix for a description of the Architectural Styles found in the Old Town Historic District.

The majority of the buildings styles found in the Old Town Historic District are shown here.



Nineteenth-Century Commercial, Italianate architectural style that is fifty feet or more with multiple entrances.

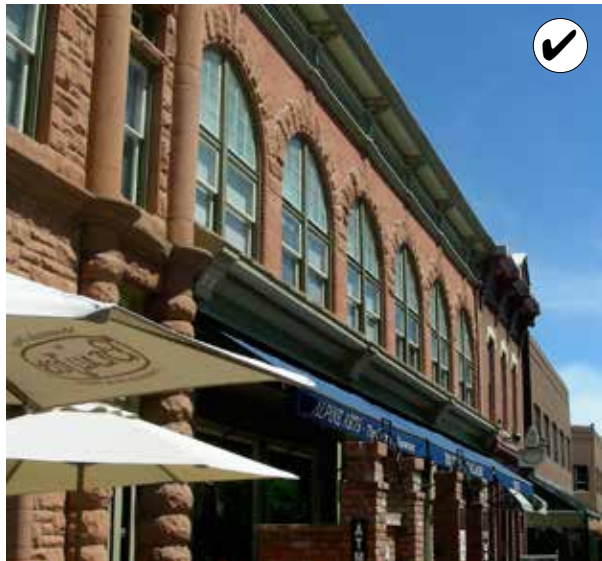

Nineteenth-Century Commercial, Richardsonian Romanesque architectural style



Early Twentieth - Century Commercial, single storefront.

Historic Architectural Styles

Information about Fort Collins's historic architectural styles is available from a number of sources, including:

- › *The City of Fort Collins Historic Preservation Division*
- › *City of Fort Collins, Central Business District Development and Residential Architecture, Historic Contexts, November 1992*
- › *A Cultural Resources Inventory of The Old Fort Site, Fort Collins, Colorado, June 2002*
- › See History Colorado web link at:

<http://www.historycolorado.org/archaeologists/colorados-historic-architecture-engineering-web-guide>

See also the following reference book:

- › *What Style is it? A Guide to American Architecture.* John C. Poppeliers, S. Allen Chambers, Jr., Nancy B Schwartz. Historic Building Survey, National Park Service, US Department of the Interior. 1983
- › *Visual Dictionary of Architecture.* Francis D.K. Ching. John Wiley & Sons, Inc. 1995
- › *A Field Guide to American Houses.* Virginia & Lee McAlester. New York, Alfred A. Knopf. 1984

Overarching Preservation Principles



Protect and maintain significant features and stylistic elements.

The following design principles apply to all historic properties and will be used when evaluating the appropriateness of related work:

2.1 Respect the historic character of a property.

- › The basic form and materials of a building, as well as architectural details, are a part of the historic character.
- › Don't try to change the style of a historic resource or make it look older than its actual age.
- › Confusing the character by mixing elements of different styles or periods can adversely affect the historic significance of the property.

2.2 Seek uses that are compatible with the historic character of the property.

- › Converting a building to a new use different from the historic use is considered to be an "adaptive reuse," and is a sound strategy for keeping an old building in service. For example, converting a residential structure to offices is an adaptive use. A good adaptive use project retains the historic character of the building while accommodating a new function.
- › Every effort shall be made to provide a compatible use for the building that will require minimal alteration to the building and its site.

- › Changes in use requiring the least alteration to significant elements are preferred. In most cases designs can be developed that respect the historic integrity of the building while also accommodating new functions.

2.3 Protect and maintain significant features and stylistic elements.

- › Distinctive stylistic features and other examples of skilled craftsmanship shall be preserved. The best preservation procedure is to maintain historic features from the outset to prevent the need for repair later. Appropriate maintenance includes rust removal, caulking and repainting.
- › These features shall not be removed.

2.4 Repair deteriorated historic features and replace only those elements that cannot be repaired.

- › When necessary, upgrade existing materials, using recognized preservation methods. If disassembly is necessary for repair or restoration, use methods that minimize damage to historic materials and facilitate reassembly.



III
DESIGN STANDARDS FOR THE
TREATMENT OF HISTORIC RESOURCES

Design Standards for the Treatment of Historic Resources

The City seeks to preserve the historic integrity of properties of historic significance in the Old Town Historic District. This means employing best practices in property stewardship to maintain the key character-defining features of individual historic resources, as well as maintaining the context in which they exist.

This section provides standards for the treatment of historic properties in Old Town. It focuses on the rehabilitation and maintenance of character-defining features of each individual contributing property as well as the district as a whole. The standards in this section do not apply to new construction.

The standards translate the general principles for historic preservation outlined in the preceding chapter to the treatment of individual building features and components that are found typically in the district.

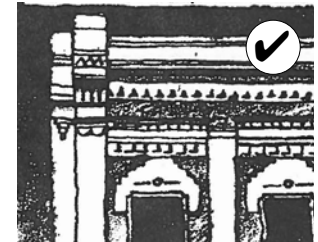
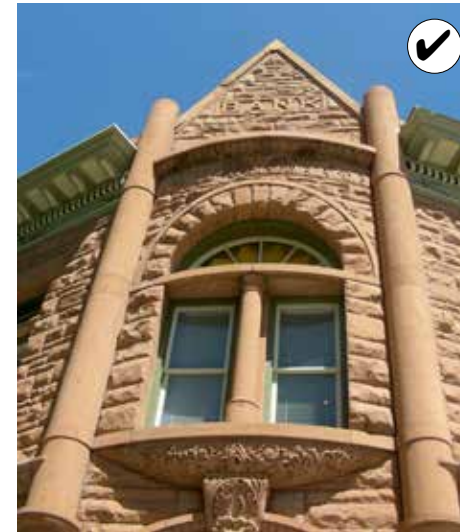

ARCHITECTURAL DETAILS

Architectural details help convey the historic and architectural significance of historic properties, and shall be preserved. The method of preservation that requires the least intervention is expected.

3.1 Maintain significant architectural details.

- › Retain and treat exterior stylistic features and examples of skilled craftsmanship with sensitivity.
- › Employ preventive maintenance measures such as rust removal, caulking and repainting.



Architectural details help convey the significance of historic properties, and shall be preserved. The method of preservation that requires the least intervention is expected.

For More Information

See web link to *Preservation Brief 17: Architectural Character - Identifying the Visual Aspects of Historic Buildings as an Aid to Preserving Character.*

<http://www.nps.gov/tps/how-to-preserve/briefs/17-architectural-character.htm>

Maintain significant architectural details, including: projecting cornices, masonry patterns, decorative moldings, double-hung wood windows and other decorative features.



Retain and treat exterior stylistic features and examples of skilled craftsmanship with sensitivity.

Historic Architectural Details

Typical historic architectural details to preserve include:

- › Cornices and eaves
- › Moldings and brackets
- › Windows and doors and surrounds
- › Modillions and other surface ornamentation
- › Columns
- › Storefronts
- › Please see the Architectural Styles section in the Appendix.

For More Information

See web link to *Preservation Brief 27: The Maintenance and Repair of Architectural Cast Iron*

<http://www.nps.gov/tps/how-to-preserve/briefs/27-cast-iron.htm>

and

See web link to *Preservation Brief 47: Maintaining the Exterior of Small and Medium Size Historic Buildings*

<http://www.nps.gov/tps/how-to-preserve/briefs/47-maintaining-exteriors.htm>

3.2 Repair, rather than replace, significant architectural details if they are damaged.

- › Do not remove or alter distinctive architectural details that are in good condition or that can be repaired.
- › Document the location of a historic feature that must be removed to be repaired so it may be repositioned accurately.
- › Patch, piece-in, splice, consolidate or otherwise upgrade deteriorated features using recognized preservation methods.
- › Minimize damage to historic architectural details when repairs are necessary.
- › Protect significant features that are adjacent to the area being worked on.

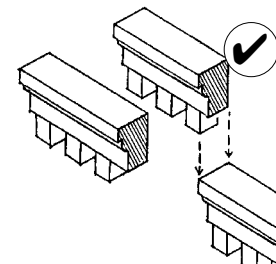

Patch, piece-in, splice, consolidate or otherwise upgrade deteriorated features using recognized preservation methods.

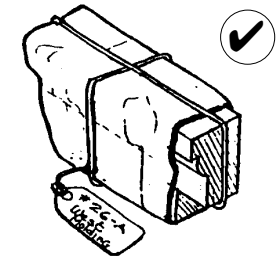

Document the location of a historic feature that must be removed and repaired so it may be repositioned accurately.

3.3 Reconstruct an architectural feature accurately if it cannot be repaired.

- › Use a design that is substantiated by physical or pictorial evidence to avoid creating a misrepresentation of the building's history.
- › Use the same kind of material as the historic detail. However, an alternative material may be considered if it:
 - › Has proven durability
 - › Has a size, shape, texture and finish that conveys the visual appearance of the historic feature.
 - › Is located in a place that is remote from view or direct physical contact
- › Do not add architectural details that were not part of the historic structure. For example, decorative millwork shall not be added to a building if it was not a historic feature as doing so would convey a false history.



During rehabilitation (ca. 1982)

The rehabilitation of the Reed and Dauth building included reconstruction of missing features. Using historic photographs, a cornice was constructed to match the historic in character. An alternative material (wood) was used instead of the historic metal.



Before rehabilitation (ca. 1980)



During rehabilitation (ca. 1982)



The rehabilitated Reed and Dauth building, 223 Linden Street (2013)



Use historic photos as a source for reconstructing a missing detail.



Interim image of missing cornice.



These buildings demonstrate a successful reconstruction of a missing cornice. See the image above for the historic condition. Loomis Building, 213-217 Linden Street

MATERIALS AND FINISHES

Historic materials shall be preserved in place. If the material is damaged, limited replacement to match the historic should be considered. Historic building materials shall never be covered or subjected to harsh cleaning treatments. Preserving historic building materials and limiting replacement to only pieces which are deteriorated beyond repair also reduces the demand for, and environmental impacts from, the production of new materials and therefore supports the city's sustainability objectives.

3.4 Maintain historic building materials.

- › Protect historic building materials from deterioration (see “Maintaining Historic Materials” at right for information on treating different types of materials).
- › Do not remove historic materials that are in good condition.
- › Use a low pressure water wash if cleaning is permitted. Chemical cleaning may be considered if a test patch does not have a negative effect on the historic fabric (test patch shall be reviewed by City preservation department).
- › Do not use harsh cleaning methods, which can inhibit the function and/or appearance of the historic material, (such as sandblasting, which can damage its protective coating.)

Maintaining Historic Materials

Primary historic building materials include masonry (brick, mortar, stone, and concrete), wood and metal. These shall be preserved and repaired.

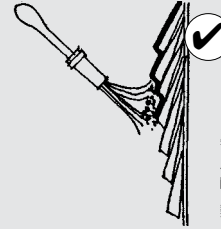

Appropriate treatments to protect specific materials from deterioration include:

Masonry

- › Maintain the natural water-protective layer (patina).
- › Do not paint, unless it was painted historically (this can seal in moisture, which may cause extensive damage over time).
- › Re-point deteriorated masonry mortar joints with mortar that matches the strength, composition, color and texture of the historic material.

Wood

- › Maintain paint and other protective coatings to retard deterioration and ultraviolet damage.
- › Provide proper drainage and ventilation.

Metal

- › Maintain protective coatings, such as paint, on exposed metals.
- › Provide proper drainage.



Re-point mortar joints where there is evidence of deterioration. This shall match the historic design.

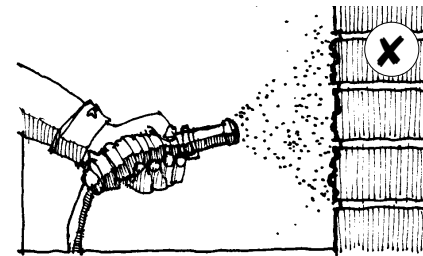

Do not use harsh cleaning methods, such as sandblasting, which can damage historic materials.



Historic building materials are key features of historic buildings and shall be preserved.

Typical Materials

Typical historic building materials used in Old Town Fort Collins include:

- » Masonry
 - › Brick
 - › Stone
 - › Terra Cotta
 - › Poured Concrete
 - › Pre-cast Concrete
- » Wood
- » Metal
 - › Cast iron,
 - › Copper
 - › Sheet metal

Understanding the character of these materials and the patterns they create is essential to their preservation, and, when appropriate, the use of alternative materials.

For More Information

See web link to *Preservation Brief 16: The Use of Substitute Materials on Historic Building Exteriors*.

<http://www.nps.gov/tps/how-to-preserve/briefs/16-substitute-materials.htm>

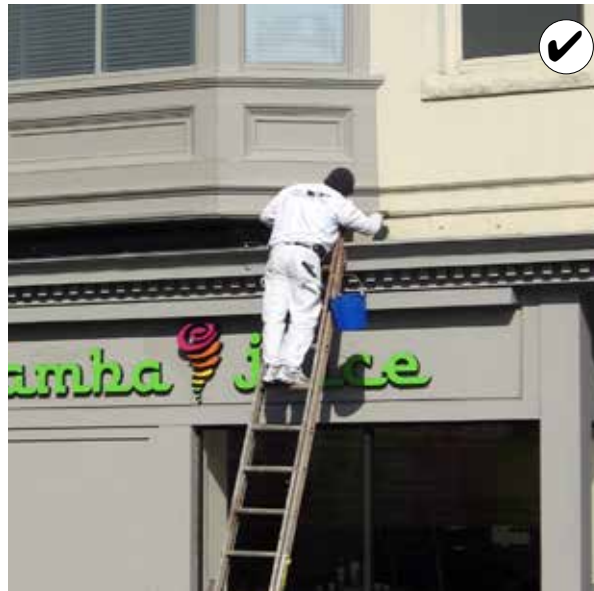

Repair deteriorated building materials, when needed.

Alternative or replacement materials shall match the style and detail of the historic fabric and be durable in the local climate, such as these cast concrete details that replace missing stone features.



3.5 Repair historic building materials when needed.

- › Repair deteriorated building materials by patching, piecing-in, consolidating, or otherwise reinforcing the material.
- › Replace only those materials that are deteriorated, and beyond reasonable repair.

3.6 Replace historic building materials in kind.

- › Use the same material as the historic material to replace damaged building materials.
- › Also use historic materials to replace damaged building materials on a non-primary façade.
- › Replace only the amount of material that is beyond repair.
- › Use only replacement materials that are similar in scale, finish and character to the historic material.
- › Use only replacement materials with proven durability.
- › Do not replace building materials, such as masonry and wood siding, with alternative or imitation materials, unless no other option is available.

3.7 Preserve the visibility of historic materials.

- › Consider removing later covering materials that have not achieved historic significance.
- › Once a non-historic material is removed, repair the historic, underlying material.
- › Do not cover or obscure historic building materials.
- › Do not add another layer of new material if a property already has a non-historic building material covering the historic material.

For More Information

See web link to *Preservation Brief 1: Assessing Cleaning and Water-Repellent Treatments for Historic Masonry Buildings*

<http://www.nps.gov/tps/how-to-preserve/briefs/1-cleaning-water-repellent.htm>

See web link to *Preservation Brief 2: Repointing Mortar Joints in Historic Masonry Buildings*

<http://www.nps.gov/tps/how-to-preserve/briefs/2-repoint-mortar-joints.htm>



Consider removing later covering materials that have not achieved historic significance (left) to reveal the underlying historic materials (right).



Historic Window Components

Window components include:

- › Sash
- › Frame
- › Number of lights (panes)
- › Shutters
- › Security Devices (bars and screens)
- › Insect screens
- › Storm windows

WINDOWS

Historic windows help convey the significance of historic structures, and shall be preserved. They can be repaired by re-glazing and patching and splicing elements such as muntins, the frame, sill and casing. Repair and weatherization also is often more energy efficient, and less expensive, than replacement. If a historic window cannot be repaired, a new replacement window shall be in character with the historic building.

3.8 Maintain and repair historic windows.

- › Preserve historic window features including the frame, sash, muntins, mullions, glazing, sills, heads, jambs, moldings, operation and groupings of windows.
- › Repair and maintain windows regularly, including trim, glazing putty and glass panes.
- › Repair, rather than replace, frames and sashes.
- › Restore altered window openings to their historic configuration.



Before rehabilitation: upper story windows in need of repair.



After rehabilitation: repaired windows.

3.9 Replace a historic window with a matching design if repair is not possible.

- › Replace with the same material.
- › Match the appearance of the historic window design (i.e., if the historic is double-hung, use a double-hung replacement window).
- › Maintain the historic size, shape and number of panes.
- › Match the profile of the sash, muntin and its components to the historic window, including the depth of the sash, which may step back to the plane of the glass in several increments.
- › Use clear window glazing that conveys the visual appearance of historic glazing (transparent low-e glass is preferred).
- › Do not use vinyl and unfinished metals as window replacement materials.
- › Do not use metallic or reflective window glazing.
- › Do not reduce a historic opening to accommodate a smaller window or increase it to accommodate a larger window.



Before rehabilitation: historic windows are missing.

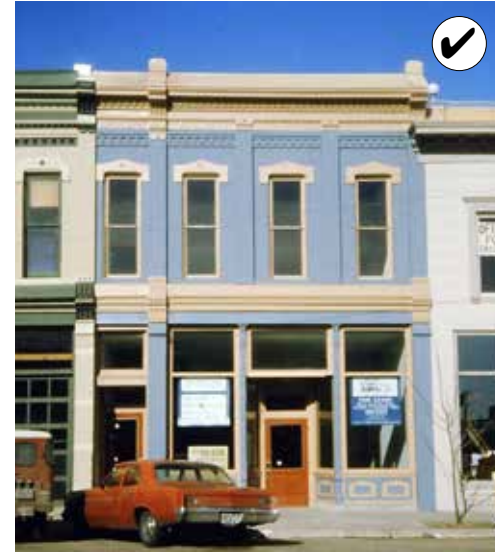

After rehabilitation: historic openings are restored.



Match the appearance of a historic window design (i.e., if the historic is double-hung, use a double-hung replacement window).



Replace historic windows (top) with a matching design (bottom), if repair is not possible.



Do not reduce a historic opening to accommodate a smaller window or increase it to accommodate a larger window.

Alternative Window Material

If it is not possible to match the historic design and materials of a window, then an alternative design may be considered in the following locations:

- › On a non-primary façade, accessory building or addition
- › On a primary façade if no other option is available

Alternative window designs shall:

- › Match the general profile and details of the historic window.
- › Use materials that match the historic appearance in dimension, profile and finish.

3.10 Use special care when replacing a window on a primary façade.

- › Give special attention to matching the historic design and materials of windows located on the façade.
- › Also, match the historic design when replacing a window located on a secondary wall.

3.11 Design a storm window to minimize its visual impacts.

- › If a window did not historically have a storm window, place a new storm window internally to avoid exterior visual impacts.
- › Use storm windows designed to match the historic window frame if placed externally.
- › Use insect screens with painted wooden frames where wood windows exist.

3.12 Restore a historic window opening that has been altered.

- › Restore a historic window opening that previously existed.
- › Place a new window to fit within the historic opening.

For More Information

See web link to *Preservation Brief 9: The Repair of Historic Wooden Windows*

<http://www.nps.gov/tps/how-to-preserve/briefs/9-wooden-windows.htm>

See web link to *Preservation Brief 13: The Repair and Thermal Upgrading of Historic Steel Windows*

<http://www.nps.gov/tps/how-to-preserve/briefs/13-steel-windows.htm>

See web link to window retrofit article from the National Trust for Historic Preservation web site

<http://www.preservationnation.org/who-we-are/press-center/press-releases/2012/new-windows-study.html>

Web link to window treatments National Park Service Tech Notes. Scroll down page to window to secure links

<http://www.nps.gov/tps/how-to-preserve/tech-notes.htm>

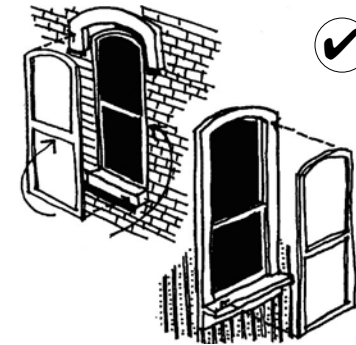

Place storm windows internally to avoid exterior visual impacts (right). Use storm window inserts designed to match the historic frame if placed externally (left).

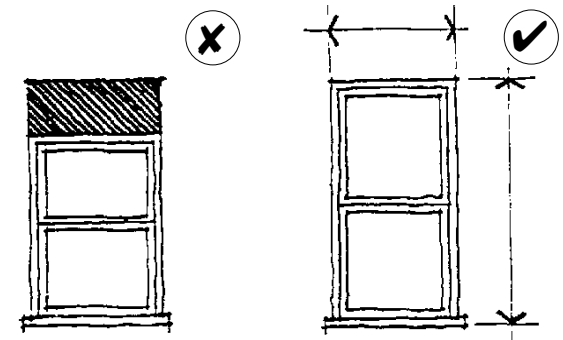

Preserve the size and proportion of a historic window opening.

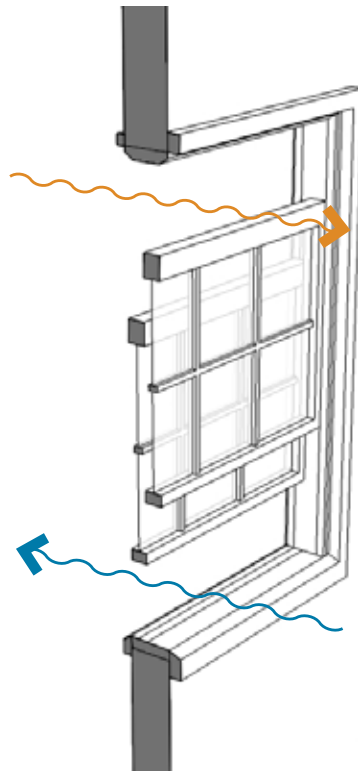

Double-hung windows found in many historic structures allow for transferring cool air in and warm air out during the summer months.

3.13 When necessary, locate and design a new window opening to preserve the overall rhythm and arrangement of windows on a secondary building wall.

- › Locate a new window opening to match the general arrangement of historic windows in a building wall.
- › Design a new window opening to match historic window proportions on the same façade.

3.14 Enhance the energy efficiency of historic windows and doors.

- › Make the best use of historic windows; keep them in good repair and seal all the leaks.
- › Maintain the glazing compound regularly. Remove old putty with care.
- › Place a storm window internally to avoid the impact upon external appearance.
- › Use storm windows designed to match the historic window frame if placed externally.

DOORS AND ENTRIES

The design, materials and location of historic doors and entries help establish the significance of a historic structure and shall be preserved. When a new door is needed, it shall be in character with the building.

3.15 Maintain a historic primary entrance.

- › Preserve historic and decorative features, including door frames, sills, heads, jambs, moldings, detailing, transoms and flanking sidelights.
- › Do not alter the historic size and shape of a historic door opening.
- › Do not change the historic locations of door openings on primary façades.
- › Do not add a new door opening on a primary façade.
- › Do not enclose transoms or sidelights.

3.16 Repair or replace a damaged door to maintain its general historic appearance.

- › Use materials that are similar to that of the historic door.
- › When replacing a historic door on a primary façade, use a design that is similar to the historic door.
- › When replacing a historic door on a non-primary façade, use a design that is in character.

Historic Door and Entry Components

Historic door and entry features include:

- › Door Detailing
- › Sills
- › Surround
- › Transoms
- › Heads
- › Threshold
- › Moldings
- › Jambs
- › Landing (i.e., mosaic tiles)
- › Flanking sidelights
- › Hardware



The design, materials and location of historic doors and entries help establish the significance of a historic structure and shall be preserved.



Maintain a historic primary entrance design.



Design a new door or entry to match historic door proportions.



3.17 Locate and design a new door and entry to preserve the historic composition.

- › Locate a new door to be consistent with the historic architectural style of the structure.
- › Design a new door or entry to match historic door proportions.

COMMERCIAL STOREFRONTS

A historic commercial storefront is a key defining feature of a historic commercial building and shall be preserved. A historic storefront is usually framed by masonry side walls and a horizontal cornice or lintel above the storefront windows. The space within is highly transparent, including large transom windows over the display windows. A store entrance is usually recessed behind the plane of the façade and the cornice or lintel separates the storefront from upper floors.

Preserving significant historic storefronts and reconstructing altered or missing storefront features is a key goal. Researching archival materials such as historic photos and building plans can be helpful in understanding the role of the storefront and its relationship to the street.

3.18 Maintain and repair a historic commercial storefront.

- › Maintain interest for pedestrians by maintaining an active street level storefront.
- › Preserve the storefront glass if it is intact.
- › Repair historic storefront elements by patching, splicing, consolidating or otherwise reinforcing the historic materials.
- › Do not alter the size and shape of a storefront opening.
- › Do not use reflective, opaque or tinted glass.
- › Do not remove or enclose a transom.
- › Retain the relationship of the storefront to the sidewalk.

3.19 Replace storefront features to match historic features if necessary.

- › Use traditional materials such as masonry and wood.
- › If using traditional materials is not possible, use compatible substitute materials that are similar in scale, finish and character to the historic material, and have proven durability in the local climate.
- › Use historical documentation to guide the design of replacement features, or design simplified versions of similar elements seen on nearby historic properties, if no documentation is available.
- › Expose historic storefront elements that have been covered by modern siding or other materials.

For More Information

See web link to *Preservation Brief 11: Rehabilitating Historic Storefronts*

<http://www.nps.gov/tps/how-to-preserve/briefs/11-storefronts.htm>



Before rehabilitation: historic storefront components survive. (ca. 1980)



After the initial rehabilitation storefront components are retained. (ca. 1982)



Storefront components continue to be preserved. (2013)

Contemporary Storefront Designs

When a historic storefront is largely missing, it may be appropriate to design a replacement that is a contemporary interpretation of a traditional storefront. A contemporary replacement design shall:

- › Promote pedestrian interest and an active street-level façade
- › Use high-quality, durable materials that are similar in type and scale to traditional materials
- › Be located within the historic structural frame of sidewalls and lintel or cornice that spaces the storefront opening
- › Convey the characteristics of typical historic storefronts
- › Include traditional storefront elements such as a bulkhead and transom
- › Maintain the transparent character of the display windows
- › Provide a recessed entry
- › Use a simple and relatively undecorated design
- › Relate to traditional elements of the façade above
- › Preserve early storefront alterations that have become historically significant

Traditional Commercial Storefront Features

Historic commercial storefronts typically feature a tall ground floor level while upper stories have shorter floor-to-floor heights. The key character-defining features of a commercial storefront are:

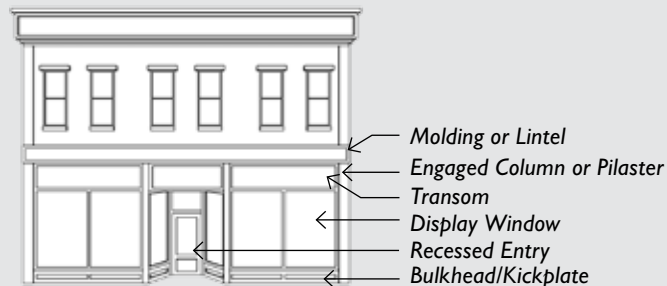

3.20 Reconstruct a missing storefront to match the character, scale and materials of the historic.

- › Use historical documentation to guide the design of the reconstruction.

3.21 A simplified or contemporary interpretation of a traditional storefront may be considered where the historic storefront is missing and no evidence of it exists.

- › Where the historic is missing and no evidence of the historic storefront exists, a new design that uses traditional features of a storefront is permitted.
- › The new design shall continue to convey the design character and materials of typical commercial storefronts. This includes the transparent character of the glass.
- › Use simple color combinations (see "Permitted Color Combinations for a Commercial Storefront" on page 61 for more information).

HISTORIC ROOFS

Many roofs in the Old Town Historic District are flat and are concealed from view, where changes may not affect the integrity of the structure. For those that are visible, the form, shape and significant materials of a historic roof help define the character of a historic structure as it is perceived from the public way and shall be preserved.

3.22 Preserve the historic roofline on a historic structure.

- › Maintain the perceived line and orientation of the roof as seen from the street.

3.23 Maintain and repair historic roof materials.

- › Preserve decorative elements, including crests and chimneys.
- › Retain and repair roof detailing, including gutters and downspouts.

EXPOSED HISTORIC FOUNDATIONS

A historic building foundation contributes to the character of a historic structure and shall be preserved.

Altering or replacing historic foundation walls is discouraged. However, it may be necessary to replace historic foundation walls with compatible new materials where the historic foundation is deteriorated beyond repair.

3.24 Maintain and repair a historic foundation.

- › Re-point historic masonry foundations to match the historic design.
- › Design landscaping and other site features to keep water from collecting near the foundation.
- › Do not cover a historic foundation with newer siding material.
- › Do not install windows, window wells or an access door on the front façade of a historic foundation.

Historic Roof Features

Historic roof features to maintain include:

- › Parapet profile
- › Historic height and profile.
- › Historic materials
- › Historic skylights
- › Parapet crests

Maintenance Tips:

- › Look for breaks or holes in the roof surface and check the flashing for open seams.
- › Watch for vegetation, such as moss and grass, which indicates accumulated dirt and retained moisture.
- › Patch and replace areas with damaged roof material (often, repairing a roof can be much less expensive than complete replacement).



Preserve traditional loading docks.

For More Information

See web link to *Preservation Brief 10: Exterior Paint Problems on Historic Woodwork*

<http://www.nps.gov/tps/how-to-preserve/briefs/10-paint-problems.htm>

3.25 Replace a foundation wall using new material that is similar in character to the historic foundation.

- › For example, if a stone foundation must be replaced, a material that conveys the scale and texture of the historic fabric may be considered.
- › Use materials and details that resemble those used in foundations on similar nearby historic properties.
- › Do not increase the height of the structure when replacing a foundation wall as it will alter the alignment of historic façades along the block and its relationship to other details on the building.

LOADING DOCKS

Historic loading docks are important character-defining features of some commercial and industrial buildings and shall be preserved. These features also influence the perceived scale of the structure. Altering, enclosing, or removing a historic loading dock is not allowed. Loading docks on the rear of a building are important to the character of a property.

3.26 Maintain and repair a historic loading dock.

- › Maintain the historic location and form of a loading dock.
- › Maintain and repair loading dock components and details, such as a canopy or railing.

COLOR

Choosing the right combination of colors for a historic rehabilitation project can unify building elements with the façade and highlight important architectural detailing. Paint color selection shall be appropriate to the architectural style and complement the building and its surroundings. Using the historic color scheme is an option, but new schemes that are compatible are also permitted.

3.27 Retain historic colors.

- › Retain the historic or early color and texture of masonry surfaces.
- › Retain historic coatings such as paint that help protect exterior materials from moisture and ultraviolet light.
- › Do not strip paint or other coatings to reveal bare wood.
- › Do not paint unpainted masonry and architectural metals.
- › Do not use destructive paint removal methods such as propane or butane torches, sandblasting or water blasting which can irreversibly damage historic materials.

3.28 Use a color scheme that is compatible with the historic character of the structure.

- › Restore historic paint colors and finishes to the extent reasonable to highlight the structure's historic appearance.
- › Repaint with colors that are appropriate to the period of historic significance of the building and district. Color selection shall be based on historic paint analysis of the historic layers of paint or appropriate historic research.
- › Use color schemes that are simple in character (generally one to three accent colors for trim elements).
- › Seek professional advice and properly prepare surfaces before painting.

Permitted Color Combinations for a Commercial Storefront

Three colors are generally sufficient to highlight a commercial storefront.

Base Color. This appears on the upper wall and frames the storefront. The major expanses on a storefront will be painted this color.

Major Trim. This defines the decorative elements of the building and ties the upper façade trim with the storefront. Elements include:

- › Building and storefront cornice
- › Window frames, sills and hoods
- › Storefront frames, columns, bulk-heads and canopies.

Minor Trim. This is intended to enhance the color scheme established by the base and major trim colors and may be used for window sashes, doors and selective details.

Preserve an older addition that has achieved historic significance in its own right.



EXISTING ADDITIONS

Some existing additions may have become historically significant in their own right. Unless the building is being accurately restored to an earlier period of significance, additions that have taken on significance shall be preserved. However, more recent additions may detract from the character of the building and could be considered for modification or removal.

3.29 Preserve an older addition that has achieved historic significance in its own right.

- › Respect character-defining building components of a historically-significant addition.
- › Do not demolish a historically-significant addition.

3.30 Consider removing an addition that is not historically significant.

- › Ensure that the historic fabric of the primary structure is not damaged when removing these features.

For More Information:

See web link to *Preservation Brief 14: New Exterior Additions to Historic Buildings: Preservation Concerns*

<http://www.nps.gov/tps/how-to-preserve/briefs/14-exterior-additions.htm>



Design an addition or secondary structure to be subordinate to the historic building.

NEW ADDITIONS AND ACCESSORY STRUCTURES

A new addition or accessory structure that is compatible with the historic building and surrounding historic context may be permitted. It is important to consider its design and placement, as well as its relationship to the surrounding historic context. The design standards for new construction also apply to the design of a new addition or accessory structure.

3.31 Design an addition or accessory structure to be compatible with the historic structure.

- › Design an addition or accessory structure to be visually subordinate to the historic building (It shall not replicate the design of the historic building.)
- › Use materials that are of a similar color, texture, and scale to materials in the surrounding historic context.
- › Design an addition or accessory structure to be compatible with the scale, massing and rhythm of the surrounding historic context.
- › Incorporate windows, doors and other openings at a consistent solid-to-void ratio to those found on nearby historic buildings.
- › Use simplified versions of building components and details found in the surrounding historic context. This may include: a cornice; a distinctive storefront or main door surround; window sills or other features.
- › Do not use replicas of historic building components and details that would convey a false history or that would draw undue attention to the addition.

3.32 Design an addition or secondary structure to be subordinate to the historic building.

- › Place an addition or secondary structure to the side or the rear of the historic structure.
- › Place a rooftop or upper-story addition to the rear to minimize visual impacts from public streets.
- › Do not locate an addition on a primary façade.

3.33 Differentiate an addition from the historic structure.

- › Use changes in material, color and/or wall plane.
- › Use a lower-scale connecting element to join an addition to a historic structure.
- › Use contemporary architectural styles or materials in an addition or a simplified version of the architectural style.

3.34 Do not try to make an addition or secondary structure appear older than it is.

- › Do not replicate historic details; use simplified versions.

3.35 Do not damage the historic fabric of the historic building when adding an addition.

- › Do not damage or obscure significant architectural features of the historic building.

Locating an Addition to a Historic Commercial Structure

An addition to a historic commercial structure shall be subordinate to, and differentiated from, the historic structure as illustrated below.

Historic Structure

The one and two-story commercial building illustrated at right are historic.

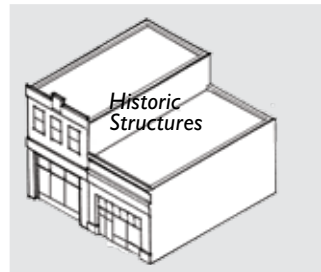

Rear Addition

The rear addition illustrated at right is appropriate.

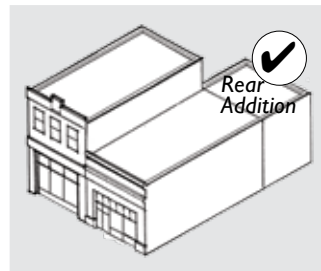

Rooftop Addition

The rooftop addition illustrated at right is appropriate because it is set back from the front façade.

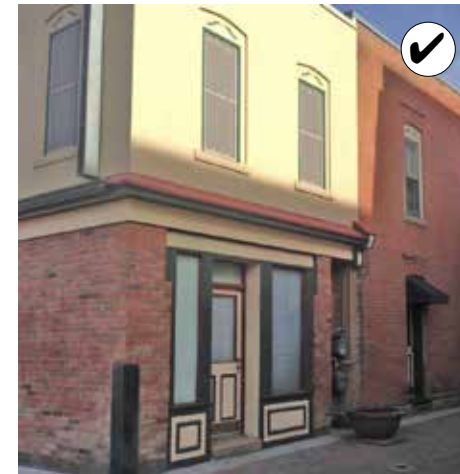
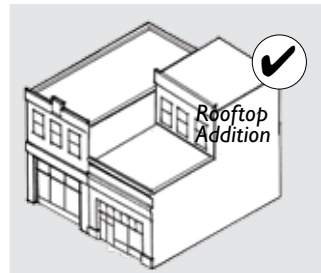

Appropriate addition to the rear of a **contributing structure**. This building addition is located on an improved alley.

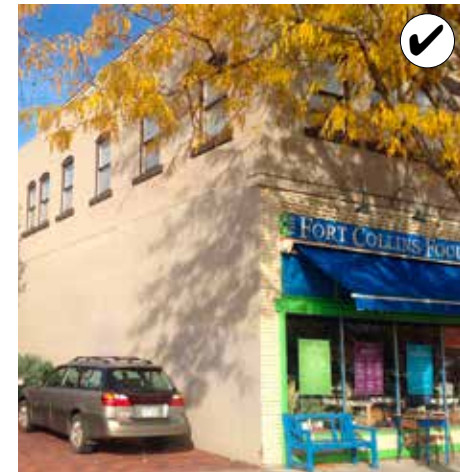

Appropriate addition to the front of a one-story **non-contributing structure**.

Planning for Energy Efficiency

PLANNING FOR ENERGY EFFICIENCY

These standards address maintaining and improving resource and energy efficiency in a historic building, as well as methods for approaching energy conservation and generation technologies. The standards in this section apply to projects involving historic buildings. Other sustainability standards throughout this document will also apply.

Objectives for historic preservation and community sustainability are often in alignment. Follow these basic steps when considering a rehabilitation project for energy efficiency:

Step 1: Establish Project Goals.

Develop an overall strategy and project goals for energy efficiency to maximize the effectiveness of a project. This will establish a broad view that can help place individual actions into context. Focus on minimizing use of resources and energy, minimizing negative environmental impacts, and retaining the historic integrity of a property. Strategies shall maximize the inherent value of the historic resource prior to considering alterations or retrofitting with new energy generation technology.

Step 2: Maintain Building Components in Sound Condition.

Maintaining existing building fabric reduces negative environmental impacts. Re-using a building preserves the energy and resources invested in its construction, and removes the need for producing new construction materials.

Step 3: Maximize Inherent Sustainable Qualities.

Typically, historic buildings in the Old Town Historic District were built with resources and energy efficiency in mind. Construction methods focused on durability and maintenance, resulting in individual building features that can be repaired if damaged, thus minimizing the use of materials throughout the building's life cycle.

Buildings were also built to respond to local climate conditions, integrating passive and active strategies for year-round interior climate control, which increase energy efficiency. Passive strategies typically include building orientation and features such as roof overhangs and windows to provide both natural day lighting as well as management of solar heat gain. Active strategies typically include operable building features such as awnings and double-hung and transom windows.

Identify a building's inherent sustainable features and operating systems and maintain them in good operating condition. In some cases these features may be covered, damaged or missing; repair or restore them where necessary.

Step 4: Enhance Building Performance.

A historic building's inherent energy efficiency shall be augmented using techniques which improve energy efficiency without negatively impacting historic building elements. Noninvasive strategies such as increased insulation, weatherization improvements and landscaping should be employed.

Step 5: Add Energy-Generating Technologies Sensitive.

The flexibility of many historic structures allows for the respectful integration of energy efficient technologies, i.e., solar panels, geo-thermal systems and thermal walls etc. Energy-generating technologies are the most commonly known strategies. However, the efficiency of a historic structure will often be great enough that generation technologies aren't the most practical solutions. Utilize strategies to reduce energy consumption prior to undertaking an energy generation project.

ENHANCING ENERGY PERFORMANCE

Improvements to enhance energy efficiency shall complement the historic building. The structure, form and materials shall be sensitively improved in energy efficiency terms to preserve the building's character.

3.36 Use noninvasive strategies when applying weatherization improvements.

- › Use cost-effective weather-stripping, insulation and storm windows to improve energy efficiency while preserving historic character.
- › Install additional insulation in an attic, basement or crawl space as a simple method to make a significant difference in a building's energy efficiency. Provide sufficient ventilation to prevent moisture build-up in the wall cavity.
- › Install weatherization strategies in a way that does not alter or damage significant materials and their finishes.
- › Use materials which are environmentally friendly and that will not interact negatively with historic building materials.
- › When a roof must be replaced, consider installing a radiant barrier.
- › Maintain historic windows; keep them in good repair and seal all leaks.
- › Retain historic glass, taking special care in putty replacement.
- › Maintain the glazing compound regularly. Remove old putty with care.
- › Use operable systems such as storm windows, insulated coverings, curtains and awnings to enhance performance of historic windows.

MAINTAINING ENERGY EFFICIENCY

The historic sustainable building features and systems of a historic building shall be maintained in good operating condition.

3.37 Preserve the inherent energy efficient features of the historic building in operable condition.

- › Identify a building's inherent sustainable features and operating systems and maintain them in good condition.
- › Retain historic shutters, awnings, canopies and transoms. Operable features such as these will increase the range of conditions in which a building is comfortable without mechanical climate controls.

Energy Audit

To inform an energy efficiency project strategy, conduct an energy audit. Energy audits can give a comprehensive view of how energy is currently managed, in the daily and seasonal cycles of use, and can also provide perspective on the payback of investment for potential work on the building. For example, an energy audit, when examined based on an overall strategy, may demonstrate that priorities shall be on increasing insulation in walls, ceilings and foundations, rather than replacing windows.

Commercial Building Energy Efficiency Diagram

This diagram summarizes the principal direction in the standards for a rehabilitation project for energy efficiency on a commercial building. These measures can enhance energy efficiency while retaining the integrity of the historic structure.

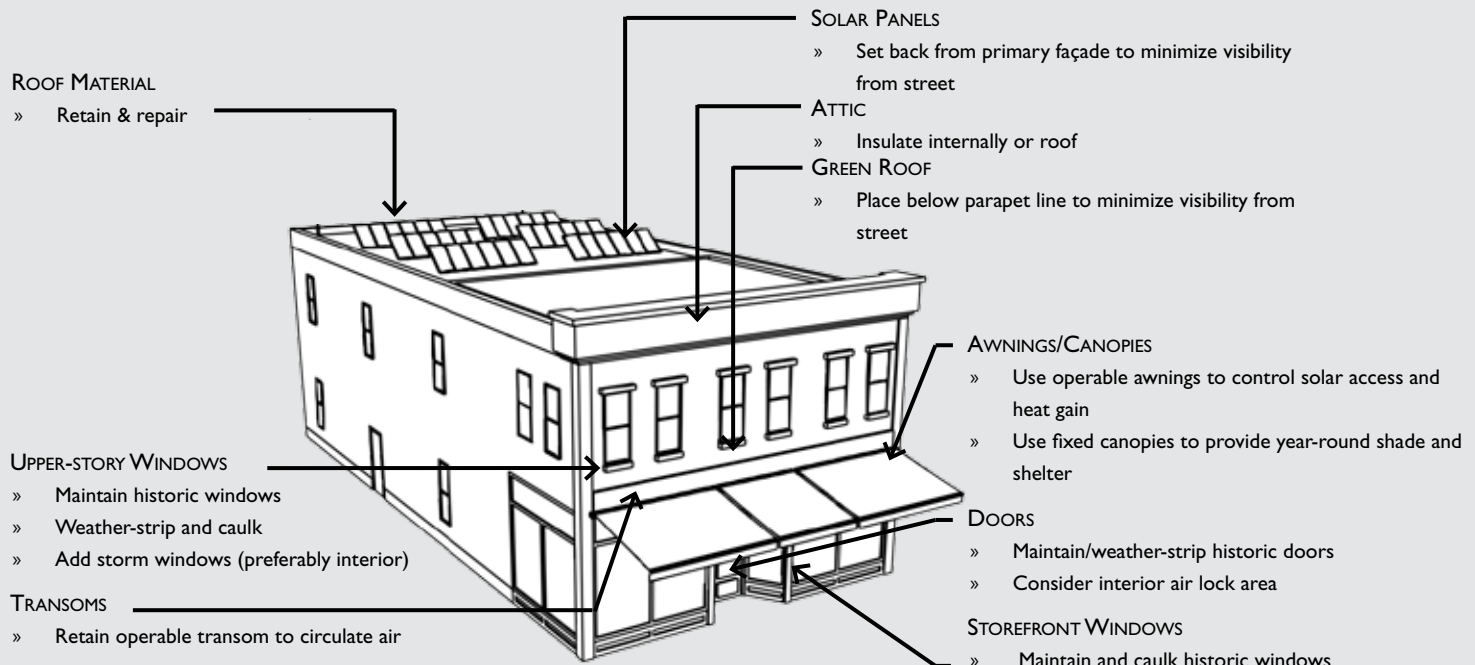

USING ENERGY GENERATING TECHNOLOGIES

Integrate modern energy technology into a historic structure while maintaining its historic integrity. Use of energy-generating technologies should be the final option considered in an efficiency rehabilitation project. Utilize strategies to reduce energy consumption prior to undertaking an energy generation project. Consider the overall project goals and energy strategies when determining if a specific technology is right for the project.

As new technologies are tried and tested, it is important that they leave no permanent negative impacts to historic structures. The reversibility (returning the building fabric to its historic condition) of their application will be a key consideration when determining if it shall be permitted.

3.38 Locate energy-generating technology to minimize impacts to the historic character of the site and structure.

- › Locate technology where it will not damage, obscure or cause removal of significant features or materials.
- › Maintain the historic character of the building.
- › Install technology in such a way that it can be readily removed and the historic character easily restored.
- › Use materials which are environmentally friendly and that will not interact negatively with historic building materials.

3.39 Install solar collectors to minimize potential adverse effects on the character of a historic property.

- › Place collectors to avoid obscuring significant features or adversely affecting the perception of the overall character of the property.
- › Size collector arrays to remain subordinate to the historic structure.
- › Install collectors on an addition or secondary structure.
- › Minimize visual impacts by locating collectors back from the front façade.
- › Ensure that exposed hardware, frames and piping have a matte finish, and are consistent with the color scheme of the primary structure.
- › Use the least invasive method to attach solar collectors to a historic roof.

3.40 Install wind turbines to minimize potential adverse effects on the character of a historic property.

- › Use turbines and any exposed hardware with a matte finish that is consistent with the color scheme of the primary structure.
- › Do not obscure significant features or impair the building's historic significance.
- › Attach turbines in a manner that avoids damage to significant features.
- › Install turbines to allow restoration of affected building areas.
- › Minimize structural impacts when installing turbines.

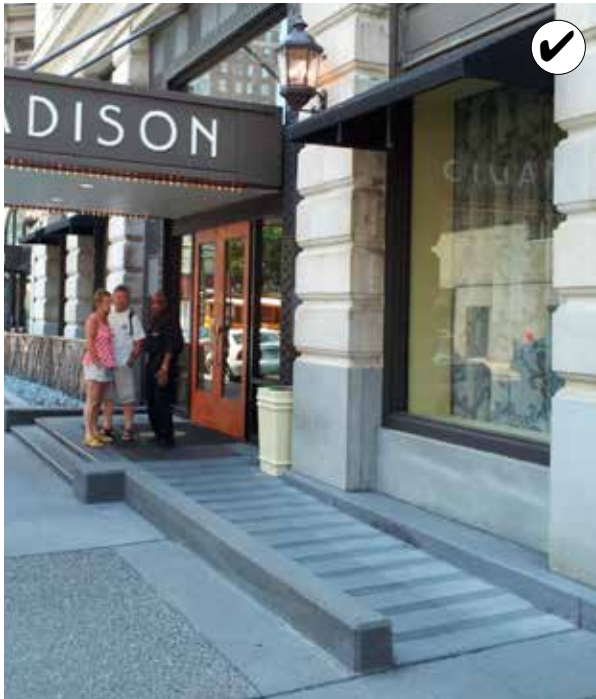

Accessibility improvements shall be designed to preserve the integrity of a historic property to the fullest.

ACCESSIBILITY

In 1990, the passage of the Americans with Disabilities Act (ADA) mandated that all places of public accommodation be accessible to everyone. This includes historic structures that are used for commercial, rental, multi-family and public uses. Note that the law provides that alternative measures may be considered when the integrity of a historic resource may be threatened. In most cases, property owners can comply without compromising the historic resource. Owners of historic properties should comply to the fullest extent feasible with accessibility laws, while also preserving the integrity of the character-defining features of their building or site. These standards shall not prevent or inhibit compliance with accessibility laws.

3.41 Accessibility improvements shall be designed to preserve the integrity of a historic property.

- › Retain the key features of the historic structure in any design.
- › Ensure that accessibility improvements are “reversible.”

PHASING PRESERVATION IMPROVEMENTS

In some cases, a property owner may wish to make interim preservation improvements, rather than execute a complete rehabilitation of a historic property. This work shall be planned such that it establishes a foundation for future improvements that will further assure continued use of the property and retain its historic significance. For example, a simplified cornice element may be installed on a commercial storefront, in lieu of reconstructing the historic design, with the intent that an accurate reconstruction would occur later.

3.42 Plan interim preservation improvements to retain opportunities for future rehabilitation work that will enhance the integrity of a historic property.

- › Preserve key character-defining features while making interim preservation improvements.
- › Interim preservation improvements that would foreclose opportunities for more extensive rehabilitation in the future are inappropriate.
- › See photo sequence on page 28.

TEMPORARY STABILIZATION TREATMENTS

When a building is to be unoccupied for an extended period of time, it shall be secured in a way in which to preserve historically significant features and prevent deterioration from weathering or vandalism. Often termed “mothballing,” such procedures are particularly relevant to properties that have been vacant for a long time. Stabilization shall be planned such that the integrity of the property will be maintained.

3.43 If a building is unoccupied, secure it in a way that protects its historic character.

- › Maintain a weather-tight roof. Temporary roofing may be installed if needed.
- › Structurally stabilize the building, if needed.
- › When enclosing a window or door opening, do not damage frame and sash components. Mount any panel to cover the opening on the interior. Also, paint the panels to match the building color.
- › Provide adequate ventilation to the interior of the building.

EXISTING HISTORIC ALTERATIONS

Many historic structures experience changes over time as design tastes change or need for additional space occurs. Many of these occurred while retaining the characteristics that are key historic features.

Some of these alterations now may be historically significant themselves. An addition constructed in a manner compatible with the historic building and associated with the period of significance is an example, and it too may merit preservation in its own right.

In contrast, more recent alterations usually have no historic significance and may even detract from the character of the building and obscure significant features. Removing such an alteration may be considered in a rehabilitation project. Historic features that have been modified can also be restored.

3.44 Consider the significance of early alterations and additions. Consider these options:

- › Preserve an older addition or alteration that has achieved historic significance in its own right, when it is key to understanding the history of the property.

IV

DESIGN STANDARDS FOR ALL PROPERTIES



Design Standards for All Properties

AWNINGS AND CANOPIES

Traditionally, awnings and canopies were noteworthy features of buildings in the Old Town Historic District, and their continued use is encouraged. These elements are simple in detail, and they reflect the character of the buildings to which they are attached.

4.1 Preserve traditional canopies.

- › Retain historic hardware.

4.2 Install an awning or canopy to fit the opening and be in character with the building.

- › A fabric awning is permitted.
- › A fixed metal canopy may be considered when it would be in character.
- › Mount an awning or canopy to accentuate character-defining features. The awning or canopy shall fit in the openings of the buildings.
- › Simple sloping awnings and flat canopies are permitted. Odd shapes, bullnose awnings and bubble awnings are prohibited.

4.3 Design an awning or canopy with colors and materials that are durable and compatible with the structure.

- › Use canvas or a similar woven material (preferred approach) for an awning.
- › Do not use a material without proven durability or that has a gloss finish.
- › Contemporary awnings may be considered.

- › Post supported canopies are prohibited on the front facade of a commercial building. However, they may be considered on a rear facade that faces an alley.



Design an awning or canopy with colors and materials that are durable and compatible with the structure.



Traditionally, awnings were noteworthy features of commercial buildings, and their continued use is encouraged.

For More Information

See web link to *Preservation Brief 44: The Use of Awnings on Historic Buildings, Repair, Replacement and New Design*

<http://www.nps.gov/tps/how-to-preserve/briefs/44-awnings.htm>



Awnings and canopies can help define windows, entry areas and the pedestrian level of buildings.



A small public plaza or courtyard is permitted at the rear of the structure to help to enliven the alley setting.

STREET LAYOUT

Established vehicular, pedestrian and bicycle access shall be preserved.

4.4 Retain the historic network of streets and alleys.

- › The network of streets and alleys shall be retained as public circulation space and for maximum public access.
- › Streets and alleys shall not be enclosed or closed to public access.
- › Link a new walkway to an existing public right-of-way.

OUTDOOR USE AREAS

Outdoor use areas occur as accents. These include outdoor dining areas and small public plazas. These shall be integrated with the design of the site and the building.

Small Public Plazas and Courtyards

A small public plaza or courtyard may be considered. However, within the heart of the Old Town Historic District, where the greatest concentration of historic storefronts align, creating a gap in the street wall is not allowed, because it disrupts the street wall.

4.5 A small public plaza or courtyard shall contain features to promote and enhance its use.

- › It must be: directly accessible to the public way; level with the public way;
- › It may have one or all of the following: street furniture; public art; historical/interpretive marker.

Terraces, Patios and Deck Space

Improvements that provide areas for active outdoor use (i.e., dining) are welcomed amenities, but they must be in character with the historic fabric in the Old Town Historic District. There are typically two types: raised and at-grade.

4.6 Locate a raised dining area (deck) to minimize visual impacts to the street.

- › Placing it to the rear of a property is preferred.
- › Rooftop decks shall be set back from the building facade.
- › Projecting or cantilevered decks are prohibited.
- › Dining support service areas, such as wait stations and dish areas, shall be located away from public view.

4.7 Locate an at-grade dining area to minimize impacts on the streetscape.

- › Locate an at-grade dining area to the side or rear of a property.
- › It is permissible to locate an at-grade dining area in the public ROW in a street wall context, subject to any necessary permits or encroachment agreements which may be required. The dining area shall be clearly defined in this setting.

HANDRAILS AND ENCLOSURES

In some circumstances it may be necessary to add handrails or an enclosure to a property to accommodate an outdoor dining area, accessibility or to enhance safety. If so, it must have minimal impact on the urban setting and/or the historic resource.

4.8 A railing shall be simple in design.

- › Simple metal work is permitted.
- › Very ornate metal, plastic or wood designs are prohibited.
- › The railing shall be transparent in its overall appearance. One shall be able to see through to the building.

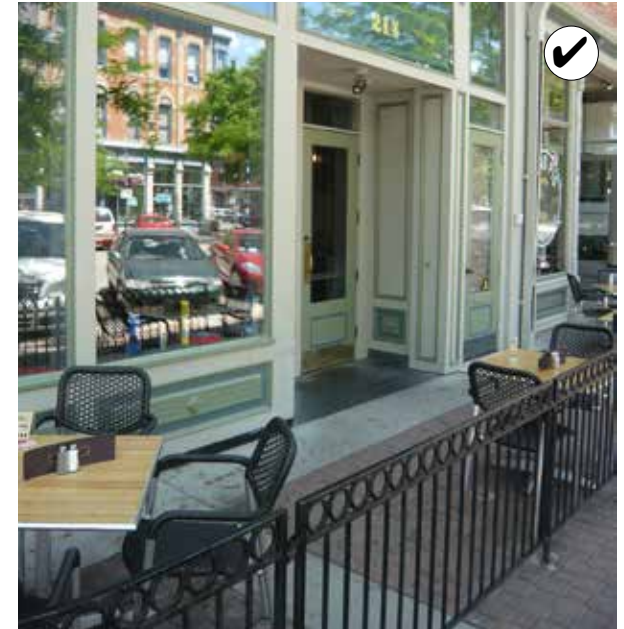

Railings shall be mostly transparent and simple in design.



ART AND HISTORIC PROPERTIES

Public art is welcomed as an amenity in Fort Collins' historic districts. It shall be planned as an integral component of the urban environment and shall be strategically located to serve as an accent to public areas. An installation on private property that is visible from the public way also shall be planned to retain the historic significance of a property.

4.9 Public art shall be compatible with the historic context.

- › An art installation shall not impede one's ability to interpret the historic character of the district.
- › Locate public art such that the ability to perceive the character of historic buildings nearby is maintained.

4.10 An art installation on a historic property shall be compatible with the resource. It shall:

- › Maintain one's ability to interpret the historic character of the resource.
- › Preserve key features that contribute to the property's significance.
- › Be reversible in a way that the key features of the property remain intact.

SITE LIGHTING

The light level at the property line is a key design consideration. This is affected by the number of fixtures, their mounting height, and the lumens emitted per fixture. It is also affected by the screening and design of the fixture. Light spill onto adjacent properties and into the night sky shall be minimized and the design shall be compatible with the district.

4.11 Shield lighting to prevent off-site glare.

- › A light fixture shall incorporate a cut-off shield to direct light downward.
- › A luminaire (lamp) shall not be visible from adjacent streets or properties.
- › Shield a fixture to minimize light spill onto adjacent properties and into the night sky.

4.12 A light fixture must be in character with the setting.

- › A fixture shall be compatible with the historic context.

BUILDING LIGHTING

The character and level of lighting that is used on a building is of special concern. Traditionally, exterior lights were simple in character and were used to highlight signs and building entrances. Most fixtures had incandescent lamps that cast a color similar to daylight, were relatively low intensity and were shielded with simple shade devices. Although new lamp types may be considered, the overall effect of modest, focused, building light shall be continued.

When installing lighting on a historic building, use existing documentation as a basis for the new design. If no documentation exists, use a contemporary light fixture that is simple in design. Building lighting shall be installed in a manner so as not to damage the historic fabric of the building and shall be reversible. Most historic lighting was subdued and directed at signs, entrances, and in a few cases, building features.

4.13 Use lighting to accent:

- › Building entrances, signs and to illuminate walkways.

4.14 Minimize the visual impacts of architectural lighting.

- › Use exterior light sources with a low level of luminescence.
- › Use lights that cast a similar color to daylight.
- › Do not wash an entire building facade in light.
- › Use lighting fixtures that are appropriate to the building and its surroundings in terms of style, finish, scale and intensity of illumination.
- › Mount exterior fixtures in an inconspicuous manner.
- › Do not damage or obscure historic building components and fabric when mounting exterior fixtures.

4.15 Use shielded and focused light sources to prevent glare.

- › Provide shielded and focused light sources that direct light downward.
- › Do not use high intensity light sources or cast light directly upward.
- › Do not allow excessive light spill from buildings.



Orient a service area towards service lanes and away from public streets.

SERVICE AREAS

Service areas shall be visually unobtrusive and must be integrated with the design of the site and the building.

4.16 Minimize the visual impacts of a service area.

- › Orient a service entrance, waste/compost disposal area or other service area toward service lanes and away from public streets.
- › Screen a service area with a wall, fence or planting, in a manner that is in character with the building and its site.

4.17 Position a service area to minimize conflicts with other abutting uses.

- › Minimize noise impacts by locating sources of offensive sounds away from other uses.
- › Use an alley.

SURFACE PARKING

The visual impact of surface parking shall be minimized. On-site parking must be subordinate to other uses and the front of the lot shall not appear to be a parking area.

4.18 Minimize the visual impact of surface parking.

- › Locate a parking area at the rear or to the side of a site or to the interior of the block. This is especially important on corner properties. Corner properties are generally more visible than interior lots, serve as landmarks and provide a sense of enclosure to an intersection.

4.19 Site a surface lot so it will minimize gaps in the continuous building wall of a commercial block.

- › Where a parking lot shares a site with a building, place the parking at the rear of the site.

4.20 Provide a visual buffer where a parking lot abuts a public way.

- › A landscaped strip or planter using a combination of trees and shrubs is permitted.
- › A low, decorative wall as a screen for the edge of the lot is also permitted. Materials must be compatible with those of nearby buildings.

BUFFERS

Parking, storage and equipment areas shall be visually buffered with landscaping or a screen wall. The design must complement the context.

4.21 Provide a visual buffer along the edge of a parking lot or service area.

- › Use a landscape strip or screen wall at the edge of a parking lot.
- › Provide a landscape buffer or screen wall by ground mounted mechanical equipment, service and/or storage areas.

BUILDING EQUIPMENT

Junction boxes, external fire connections, telecommunication devices, cables, conduits, satellite dishes, HVAC equipment and fans may affect the character of a property. These and similar devices shall be screened from public view to avoid negative effects.

4.22 Minimize the visual impacts of building equipment on the public way and the district as a whole.

- › Screen equipment from view.
- › Do not locate equipment on a primary facade.
- › Use low-profile or recessed mechanical units on rooftops.
- › Locate satellite dishes and mechanical equipment out of public view.
- › Locate utility lines and junction boxes on secondary and tertiary walls, and group them.
- › Group utility lines in conduit, and paint these elements, to match the existing background color.
- › Locate a utility pedestal (ground mounted) to the rear of a building.

Parking Buffers



Consider the use of a landscaped strip or planter to provide a visual buffer where a parking lot abuts a public sidewalk.

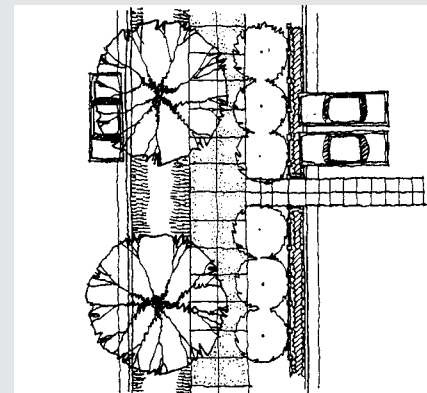
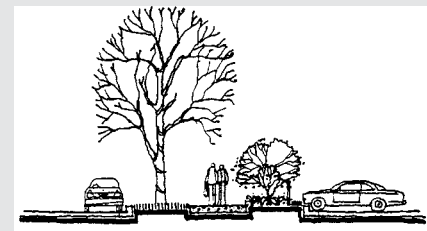

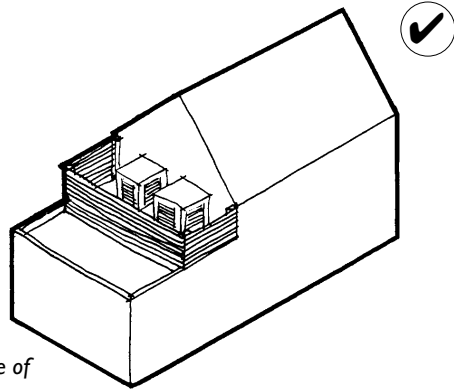

Back side of building.

Install roof-mounted mechanical equipment, such as air conditioners, to be inconspicuous when viewed from public streets.

4.23 Install mechanical equipment to minimize impacts on historic fabric.

- › Install mechanical equipment in areas and spaces that require the least amount of alteration to the historic building.
- › Do not damage or cut holes in important architectural features, such as cornices, decorative ceilings and paneling.
- › Do not install mechanical equipment on a primary façade.

SECURITY DEVICES

It may sometimes be necessary to provide a security device on a building. It shall be designed to be as inconspicuous as possible, and must not alter significant architectural features of the building. The use of interior, operable, transparent devices is preferred.

4.24 Minimize the visual impact of security devices.

- › Locate a security device inside a storefront.
- › Use operable and transparent (simple bars with spacing so one can view through to display) security devices on ground floor storefronts.
- › Opaque, roll-down metal screens are prohibited, because these obscure products on display and thereby weaken the interest of the street to pedestrians when in a closed position.
- › Decorative security devices are permitted when they complement the architectural style.
- › Security devices are prohibited above the second floor, unless unique security conditions are indicated.

4.25 Do not damage the character of the historic building when installing a security device.

- › Do not damage or obscure significant architectural features of the historic building.
- › The installation shall be reversible. Once removed the historic building must remain intact and the integrity of historic materials shall not be compromised.



Decorative security devices are permitted when they complement the architectural style.

COLOR

Traditionally, color schemes in the Old Town Historic District were relatively muted. A single base color was applied to the primary wall plane. Then, one or two accent colors were used to highlight ornamental features, as well as trim around doors and windows. Since many of the commercial structures were unpainted brick, the natural color of the masonry became the background color. Sometimes a contrasting masonry was used for window sills and moldings. As a result, the contrast between the base color and trim was relatively subtle. These traditions of using limited numbers of colors, and muted ones, shall be continued.

These standards do not specify which colors should be selected, but rather how they shall be used.

4.26 The facade shall “read” as a single composition.

- › Employ color schemes that are simple in character.
- › Using one base color for the building walls and another for the roof is preferred.
- › Using one to three accent colors for trim elements is also preferred.

4.27 Base or background colors shall be muted.

- › Building features shall be muted, while trim accents can be either a contrasting color or a harmonizing color.
- › An accent color shall not contrast so strongly as to not read as part of the composition.
- › Bright high-intensity colors are not permitted.
- › Use matte or low luster finishes instead of glossy ones.
- › Non-reflective, muted finishes on all features is preferred.

4.28 Building elements shall be finished in a manner similar to that seen traditionally. The following are recommended treatments:

- › Brick and stone: unpainted, natural color unless painted historically
- › Window frames and sash, doors and frame and storefronts: wood - painted; metal - anodized or baked color
- › Highly reflective materials, weathered wood and clear finishes are prohibited on large surfaces. A clear finish is permitted on a wood entry door.

ARCHEOLOGICAL RESOURCES

Negative impacts on archeological resources shall be avoided.

4.29 Leave archeological resources in place, to the maximum extent feasible.

- › Avoid disturbing known archeological resources.
- › If archeological materials are discovered contact the City of Fort Collins Historic Preservation office.



DESIGN STANDARDS FOR NEW CONSTRUCTION



Overview

Designing a new building to fit within the historic character of the Old Town Historic District requires careful thought. Preservation in a historic district context does not mean that the area must be “frozen” in time, but it does mean that, when new building occurs, it shall be in a manner that reinforces the visual characteristics of the district. This does not imply, however, that a new building must look old. In fact, imitating historic styles is discouraged.

Rather than imitating older styles, a new design shall relate to the fundamental characteristics of the historic context while also conveying the design trends of today. It may do so by drawing upon basic ways of building that make up a part of the character of the district. Such features include the way in which a building is located on its site, the manner in which it relates to the street and its basic mass, form and materials. When these design variables are arranged in a new building to be similar to those seen traditionally, visual compatibility results.

This section provides design standards for new infill construction and improvements to buildings that contribute to the fabric in the Old Town Historic District.

- › Building Placement and Orientation
- › Architectural Character and Detail
- › Building Mass, Scale and Height
- › Building and Roof Forms
- › Primary Entrances
- › Materials
- › Windows



The general alignment of storefronts, moldings and upper story windows contributes to the visual continuity of many commercial blocks in Old Town Fort Collins. A variation in the height of cornices exists, within a range of one to three stories. Facade widths also vary, but within a relatively narrow range.

New Additions

A new addition to an existing building in the historic district shall follow the standards for new construction provided in this section. See also the Design Standards for the Treatment of Historic Resources section, for additional standards that apply to additions to a historic structure.

New Commercial Building Design



Maintain the alignment of building fronts along the street.

Considering Context

Compatibility with the Old Town context is a key principle for the design of new construction. This typically focuses on buildings in the same block, on both sides of the street, and also across an alley. In some cases, a structure that is not historic may also be found in the immediate vicinity, but this does not influence considerations of compatibility.



Locate a primary entrance to face the street and be clearly identifiable.

BUILDING PLACEMENT AND ORIENTATION

Traditionally, buildings in Old Town were arranged in consistent development patterns, in terms of their site plan and orientation. Most commercial buildings aligned uniformly along a street. This created a consistent “street wall” that is now a key feature of the historic district.

Reinforcing traditional development patterns is paramount in designing a new building to fit within the historic district. New infill shall reflect traditional development patterns, including facade alignment and uniform building orientation.

5.1 Maintain the alignment of building fronts along the street.

- › Locate a new building to reflect established alignment patterns along the block.
- › Where historic buildings are positioned at the sidewalk edge, creating a uniform street wall, then a new building shall conform to this alignment.

5.2 Maintain the traditional pattern of buildings facing the street.

- › Locate a primary entrance to face the street and design it to be clearly identifiable.
- › For a commercial storefront, use a recessed entry.

ARCHITECTURAL CHARACTER AND DETAIL

In order to assure that historic resources are appreciated as authentic contributors in the historic district, it is important that a new building be distinguishable from them while also remaining compatible with the context. New construction shall appear as a product of its own time while also being compatible with the historically significant resources of the area.

5.3 Design a new building to express its own time while remaining compatible with the historic district.

- › See the standards that follow for information about basic elements of compatibility.

5.4 An interpretation of a historic style that is authentic to the district will be considered if it is subtly distinguishable as being new.

- › Exact imitation of a historic style that would blur the distinction between old and new buildings and make it more difficult to understand the architectural evolution of the district are not permitted.



New construction should appear as a product of its own time while also being compatible with the historically significant resources of the area.

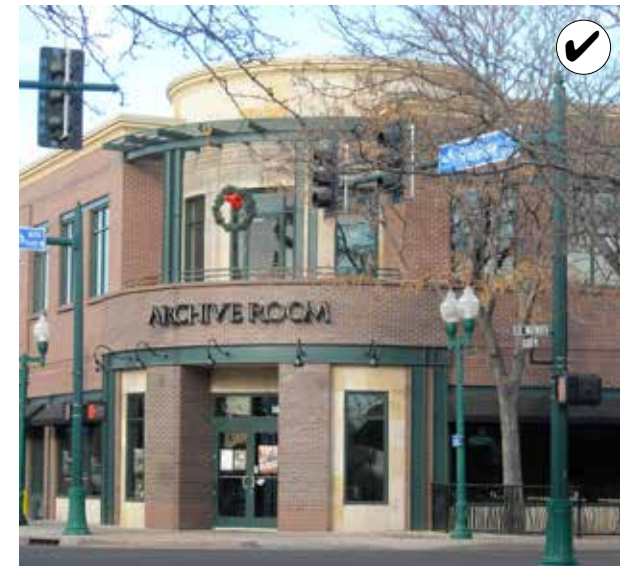

Exact imitation of a historic style that would blur the distinction between old and new buildings and make it more difficult to understand the architectural evolution of the district are not permitted.

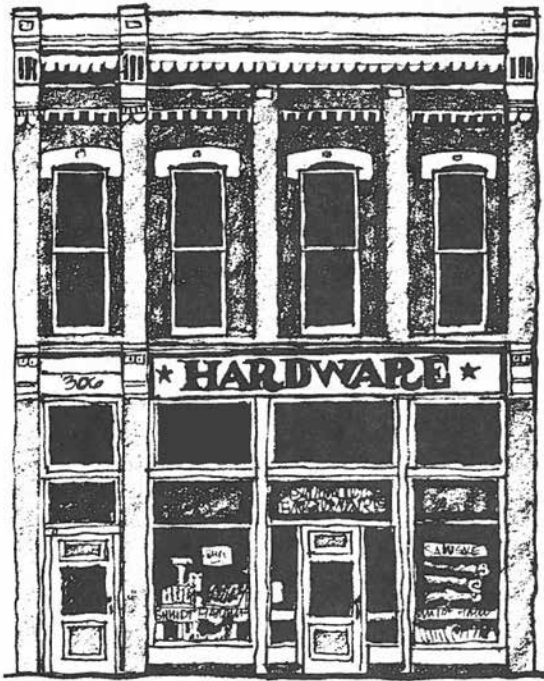

Incorporate traditional facade articulation techniques in a new design.



Design a new building to reflect its time while respecting key features of its context.

5.5 Incorporate traditional facade articulation techniques in a new design. Use these methods:

- › a tall first floor
- › vertically proportioned upper story windows
- › window sills and frames that provide detail
- › horizontal expression elements, such as canopies, belt courses, moldings and cornices
- › vertical expression features, such as columns and pilasters
- › a similar ratio of solid wall to window area
- › a base, middle and a cap



Incorporate a kickplate into a storefront design.

BUILDING MASS, SCALE AND HEIGHT

Each historic building in the district exhibits distinct characteristics of mass, height and a degree of wall articulation that contributes to its sense of scale. As groupings, these structures establish a definitive sense of scale. A new building shall express these traditions of mass and scale, and it shall be compatible in height, mass and scale with its context, including the specific block and the historic district as a whole.

5.6 Convey the traditional size of historic buildings in new construction as it is perceived at the street level.

- › The height of a new building shall appear to be within the height range established in the context, especially at the street frontage.
- › Floor-to-floor heights shall appear similar to those of traditional buildings.
- › If an additional floor is permitted, place it (or sufficient portions of it) back from the street front to maintain the traditional range of heights at the street edge.

5.7 The overall height of a new building shall be compatible with the historic district. A building height that exceeds the height range established in the context will be considered only when:

- › It is demonstrated that the additional height will be compatible with adjacent properties and for the historic district at large.
- › Taller portions are set back from the street.
- › Access to light and air of surrounding properties is respected.



The overall height of a new building shall be compatible with the historic district. A building height that exceeds the height range established in the context will be considered only when it is demonstrated that the additional height will be compatible with adjacent properties and for the historic district at large. Note the additional height on the building in the background steps back from the front and side.



The height of a new building shall appear to be within the height range established in the context, especially at the street frontage.

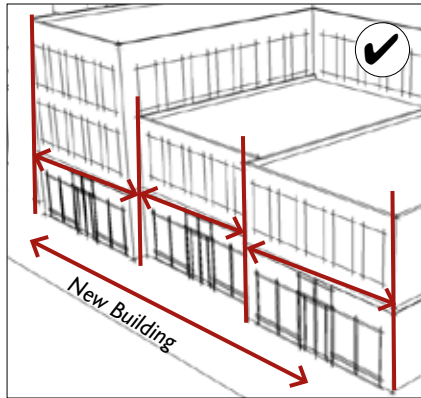

Changes in cornice lines combined with variations in wall planes can help a new, larger building appear consistent with traditional development patterns.

Mass, Scale and Height at Different Levels

Building mass, scale and height shall be considered in these ways:

(1) As experienced at the street level immediately adjacent to the building.

- › At this level of perception, the actual height of the building wall at the street edge is a key factor. The scale of windows and doors, the modular characteristics of building materials, and the expression of floor heights also contribute to perceived scale.

(2) As viewed along a block, in perspective with others in the immediate area.

- › The degree of similarity (or diversity) of building heights along a block, and the repetition of similar features, including openings, materials and horizontal expression lines, combine to establish an overall sense of scale at this level of experiencing context.

(3) As seen from key public viewpoints inside and outside of the historic district.

- › In groups, historic buildings and compatible newer structures establish a sense of scale for the entire district and define the skyline.

5.8 Provide variation in building height when a new building is substantially wider than historic buildings in the district.

- › In order to reduce the perceived mass of a larger building, divide it into subordinate modules that reflect traditional building sizes in the context.
- › Vary the height of building modules in a larger structure. The variation in height should reflect historic building heights found in the district.
- › A street wall should provide some variation in building heights, otherwise it can read as one large static mass.
- › Excessive modulation of a building mass is not permitted, since this would be out of character with simpler historic building forms in the area.

5.9 Maintain the scale of traditional building widths in the context.

- › Design a new building to reflect the traditional building widths of adjacent buildings.
- › Where a building must exceed this width, use changes in design features so the building reads as separate building modules reflecting traditional building widths and massing. Changes in the expression and details of materials, window design, facade heights or materials shall be used.
- › Where these articulation techniques are used, they shall be expressed consistently throughout the structure, such that the composition appears as several authentic building modules.

5.10 Establish a sense of human scale in a building design.

- › Use vertical and horizontal articulation techniques to reduce the apparent mass of a larger building and to create visual interest.
- › Express the position of each floor in the external skin of a building to establish a scale similar to historic buildings in the district.
- › Use materials that convey scale in their proportion, detail and form.
- › Design architectural details to be in scale with the building. Windows, doors, and storefronts (in commercial buildings) that are similar in scale to those seen traditionally shall be used.

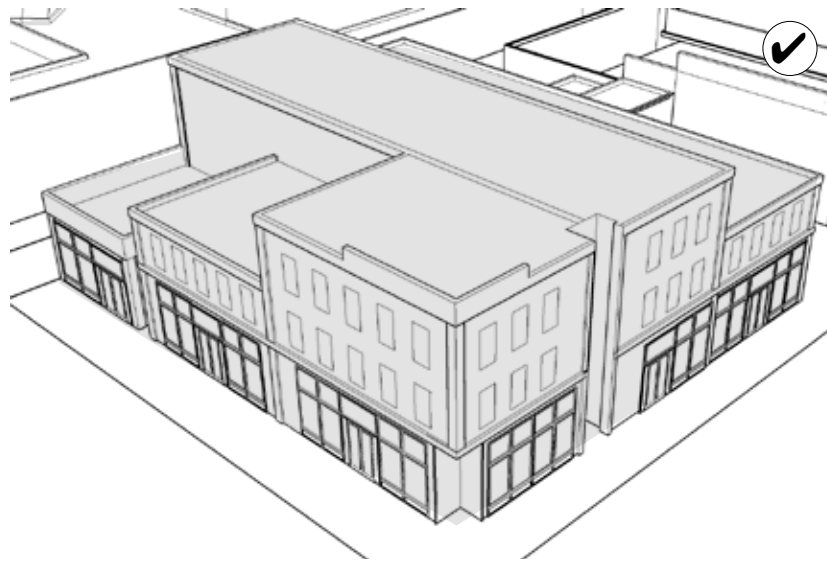

This single, new infill building is divided into modules to reflect the scale of the historic context. The height of a new building shall appear to be within the height range of historic buildings, especially at street frontage.



This single infill building successfully employs building articulation methods to break up the mass of the building. Note the height of the storefront, depth of openings and variation in parapet heights. The building also reads as separate masses with the vertical circulation offsets that have been employed.



Floor to floor heights shall appear similar to those of traditional buildings.



Use a tall first floor and vertically proportioned upper story windows.

BUILDING AND ROOF FORMS

A similarity of building forms also contributes to a sense of visual continuity. In order to maintain this feature, a new building shall have a basic form that is similar to that seen traditionally.

5.11 Use simple, rectangular building forms.

- › Use building forms that are similar to traditional forms.
- › Use roof forms similar to those seen traditionally in the district.

ENTRANCES

Traditionally in the historic district, most primary entrances were oriented to the street and were recessed. They provide visual interest and a sense of scale to each building. A primary entrance shall be clearly identifiable in a new building and it must be in character with the building and its context. The entrance shall include features to signify it as such, and convey a sense of scale.

5.12 Orient a primary entrance towards the street.

- › Design an entrance to a commercial building to convey a sense of scale and provide visual interest.

5.13 Maintain the pattern created by recessed entryways.

- › Set the door back an adequate amount from the front facade to establish a distinct threshold for pedestrians.
- › Where an entry is to be recessed, the building line at the sidewalk edge shall be maintained by the upper floor(s).
- › Use a transom over a doorway to maintain the full vertical height of the storefront.
- › Oversized and undersized entrances are prohibited.





Use building materials that appear similar in scale, color, texture and finish to those seen historically in the district.

Typical Materials

Typical historic building materials used in Old Town Fort Collins include:

- » Masonry
 - › Brick
 - › Stone
 - › Terra Cotta
 - › Poured Concrete
 - › Pre-cast Concrete
- » Wood
- » Metal
 - › Cast iron,
 - › Copper
 - › Sheet metal

Understanding the character of these materials and the patterns they create is essential to developing new interpretations.

Using New Materials

Compatibility with historic materials can be achieved without purely replicating their traditional use. A new building material that conveys the essence of modularity and the texture and finish of historic materials, and that has proven durability in the local climate, is often compatible.

The degree to which an alternative material may be used successfully on a new building also will be influenced by the degree of consistency or variety in materials that already exists in the block.

MATERIALS

Traditional building materials in the historic district include various types of masonry, primarily brick, stone and concrete. Today, these materials are key to the character of the district.

Building materials shall reflect the range of textures, modularity and finish of those employed traditionally. They also shall contribute to the visual continuity of the specific historic district. They shall be of proven durability in similar applications.

5.14 Use building materials that appear similar in scale, color, texture and finish to those seen historically in the district.

- › Use materials that are proven to be durable in the local climate.
- › Use materials that will maintain an intended finish over time, or acquire a patina.
- › Use masonry with a modular dimension similar to typical masonry materials.
- › When an alternative material is permitted, use a durable material. (See “Using New Materials” to the left for more information.)
- › On the ground level, use materials that will withstand on-going contact with the public, sustaining impacts without compromising their appearance.

WINDOWS

The manner in which windows are used to articulate a new building wall is an important consideration in establishing a sense of scale and visual continuity. Traditionally in Old Town, a storefront system was installed on the ground floor and upper story windows often appeared as punched openings.

These features often align with others in the block, and establish a rhythm or pattern of solid and void that visually links buildings along the street. These traditional arrangements may also be interpreted in contemporary designs that complement the established patterns within the historic district.

Window design and placement shall establish a sense of scale and provide pedestrian interest. Established solid to void patterns shall be maintained. Contemporary and creative design interpretations of window rhythms and patterns that reference, but do not duplicate historic designs, may be considered.

5.15 A contemporary storefront design is permitted if it reinforces the visual characteristics of the district.

- › Design a building to incorporate a ground floor storefront.
- › Basic design features found in traditional storefronts, such as a kickplate, display window, transom and a primary entrance shall be incorporated.
- › In storefront details, use elements similar in profile and depth of detailing seen historically.



Incorporate the basic design features found in traditional storefronts, such as a kickplate, display window, transom and a primary entrance.



Design a building to incorporate a ground floor storefront.



Arrange windows to reflect the traditional rhythm and general alignment of others in the area.

5.16 Arrange windows to reflect the traditional rhythm and general alignment of others in the district.

- › Use window rhythms and alignments similar to traditional buildings, such as: vertically proportioned, single or sets of windows, “punched” into a more solid wall surface, and evenly spaced along upper floors; window sills or headers that align; and rows of windows or storefront systems of similar dimensions, aligned horizontally along a wall surface
- › Creative interpretations of traditional window arrangement may be considered.

5.17 Use durable window materials.

- › Permitted window materials include metal and wood frame.
- › Prohibited window materials include synthetic materials that do not have a proven durability, such as plastic snap-in muntins.

New Construction and Sustainability

ENERGY EFFICIENCY IN NEW DESIGNS

The conservation of energy is a key objective in site design, building design and building orientation. The site design process shall include an evaluation of the physical assets of the site to maximize energy efficiency and conservation in the placement and design of a building. Designs shall consider seasonal changes in natural lighting and ventilation conditions.

A design shall also take into account the potential effect on an adjoining property, in terms of its solar access and ability to implement the same environmental design principles. Careful consideration shall also be given to balancing sustainable design principles with those related to maintaining the traditional character of the area.

5.18 Locate a new building, or an addition, to take advantage of microclimatic opportunities for energy conservation, while avoiding negative impacts to the historic context.

- › Orient a building to be consistent with historic development patterns.
- › Maximize energy efficiency and conservation opportunities.

5.19 Design a building, or an addition, to take advantage of energy saving and generating opportunities.

- › Design windows to maximize daylighting into interior spaces.
- › Use exterior shading devices to manage solar gain in summer months. For example, use canopies or awnings on storefronts similar to how they were used traditionally.
- › Energy-generating devices, including solar collectors and wind turbines, are permitted where they also remain visually subordinate.

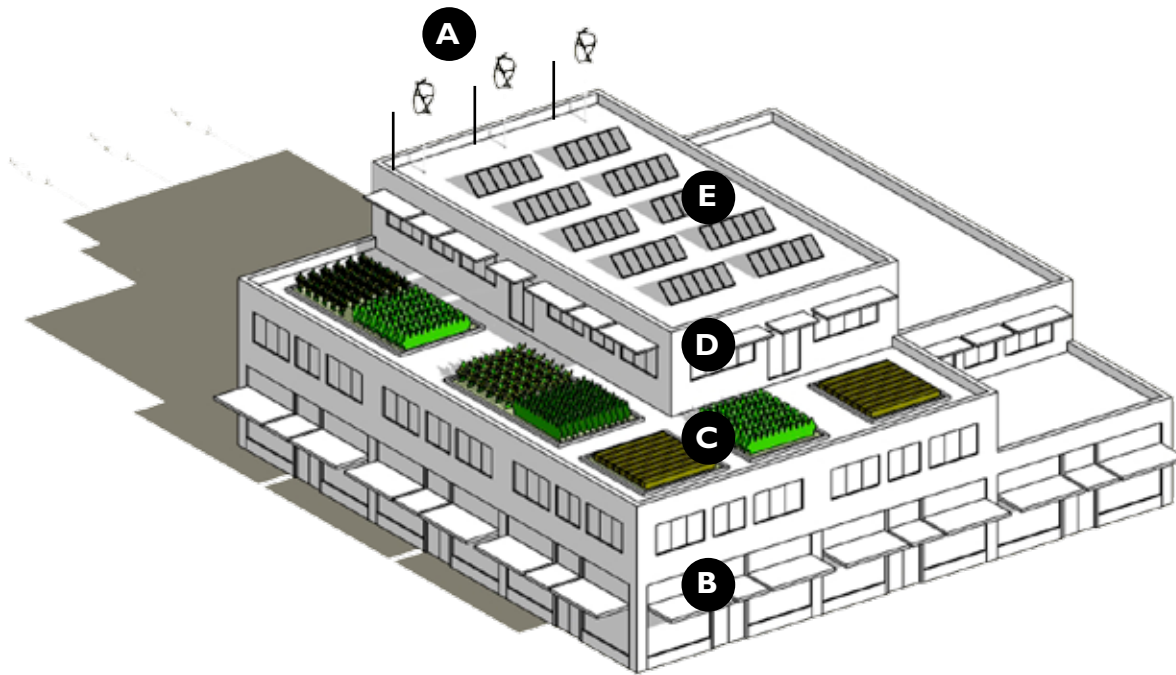

These sustainability designs should be considered in the context of an overall strategy.

COMMERCIAL ENERGY EFFICIENCY DIAGRAM

- A** **Wind Devices:** Set back from primary facade to minimize visibility from the street.
- B** **Operable Transoms:** Allows for natural air circulation.
- C** **Green Roofs:** Set back from primary facade and hide behind parapets to minimize visibility from the street.
- D** **Shading Devices:** Operable canopies located above display windows.
- E** **Solar Panels:** Set back from primary facade and hide behind parapets to minimize visibility from the street.

ENERGY EFFICIENCY IN BUILDING MASSING

A building mass shall maximize the potential for natural daylighting as well as solar energy collection, while avoiding negative impacts to the historic context.

5.20 Shape a building's mass to maximize solar energy potential. Use the following strategies:

- › Design a building to allow natural daylighting to the interior.
- › Articulate wall planes as a way to provide shade or increase solar access to interiors.
- › Use thermal storage walls on a portion of the south facing building exposure, where appropriate.

5.21 Orient a building to maximize green principles while ensuring compatibility with adjacent, lower-scale structures. Permitted strategies include:

- › Position the taller portion of a building along a north-south axis to minimize shading on lower scale structures to the north.
- › Design a building mass to minimize shading south-facing facades of adjacent buildings during winter months.

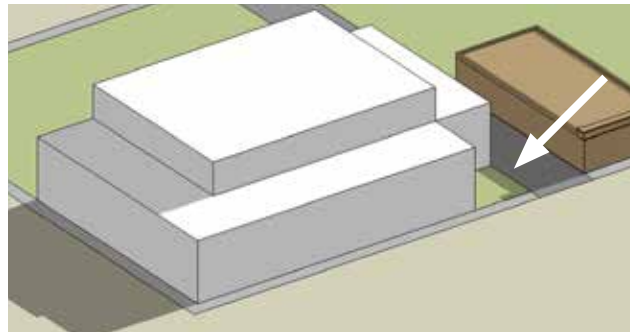
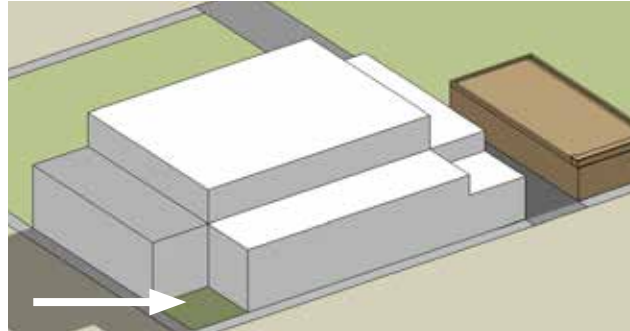

Articulate building mass to take advantage of solar energy. The image above shows a plaza to the left. It is shaded during peak winter hours, therefore the plaza location should be considered on the opposite side of the building. Below, the plaza is to the right; it is enhanced by solar rays during peak winter hours.

Green Roofs

Green roofs provide the following benefits:

- › Increase energy efficiency
- › Moderate waste diversion
- › Stormwater management
- › Reduce heat island effect
- › Improve air quality
- › Provide amenity space for building users

ENVIRONMENTAL PERFORMANCE IN BUILDING ELEMENTS

The elements that make up a new building, including windows, mechanical systems and materials, can significantly impact environmental performance. These shall be designed to maximize the building's efficiency, while promoting compatibility with surrounding sites and structures. New materials that improve environmental performance are permitted if they have been proven effective in this climate and are compatible with the historic context.

5.22 Use green building materials whenever possible. Such materials are:

- › locally manufactured
- › low maintenance
- › materials with long life spans
- › recycled materials

5.23 Incorporate building elements that allow for natural environmental control. Consider the following:

- › operable windows for natural ventilation
- › low infiltration fenestration products
- › interior or exterior light shelves/solar screens above south facing windows
- › green roofs

SOLAR AND WIND ENERGY DEVICES

Solar and wind energy devices (i.e., solar panels, wind turbines) shall be positioned to have a minimal effect on the character of Old Town.

5.24 Minimize the visual impacts of energy devices on the character of Old Town.

- › Equipment shall be mounted where it has the least visual impact.
- › Exposed hardware, frames and piping shall have a matte finish, and be consistent with the color scheme of the primary structure.

VI
DESIGN STANDARDS FOR SIGNS



Overview

Signs are important elements of Old Town and balancing their functional requirements with the objectives for the overall character of the district is a key consideration. Their placement, relationship to historic features and general character are key considerations.

This section provides standards that address the qualitative aspects of sign design, in terms of how signs contribute to the character of a historic district and to individual properties. Topics include:

- › Treatment of Historic Signs
- › Sign Installation on a Historic Building
- › Design of New and Modified Signs
- › Design of Specific Sign Types
- › Sign Illumination

Common signs types found in the district include:

- › Projecting signs
- › Flush wall signs
- › Awning signs
- › Interpretive signs
- › Window and door signs

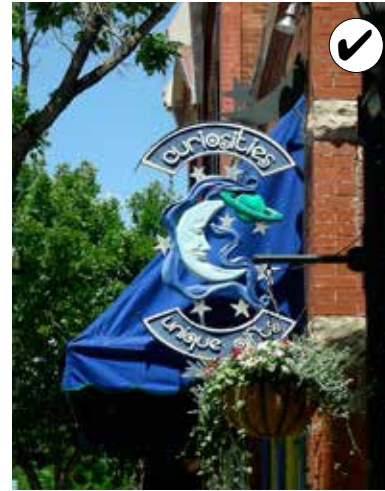
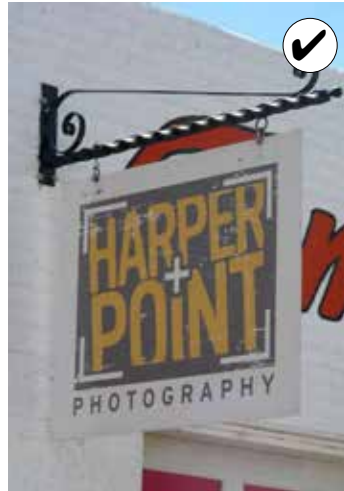

Signs are important elements of Old Town and balancing their functional requirements with the objectives for the overall character of the district is a key consideration.

Sign Code

In addition to these standards, also see the *Fort Collins Land Use Code, Division 3.8 Supplementary Regulations, 3.8.7 Signs.*

Treatment of Historic Signs



Leave historic wall signs visible.

See Also:

Web link to Preservation Brief 25: The Preservation of Historic Signs

<http://www.nps.gov/tps/how-to-preserve/briefs/25-signs.htm>

All historic signs shall be retained. Historic signs that represent the district's evolution are also important.

6.1 Consider history, context and design when determining whether to retain a sign. A sign shall be retained when the sign is:

- › Associated with historic figures, events or places.
- › Significant as evidence of the history of the product, business or service advertised.
- › A significant part of the history of the building or the historic district.
- › Characteristic of a specific historic period.
- › Integral to the building's design or physical fabric.
- › Integrated into the design of a building such that removal could harm the integrity of a historic property's design or cause significant damage to its materials.
- › An outstanding example of the sign maker's art because of its craftsmanship, use of materials, or design.
- › A historically significant type of sign

Flush wall signs and individual letter signs are signs that are mounted on a building wall. They do not project significantly from the surface to which they are mounted.

6.2 Leave a historic wall sign visible.

- › Do not paint over a historic sign.
- › There are times when some alterations to a historic wall sign may be permitted; these are:
 - › If the sign is substantially deteriorated, patching and repairing is permitted.
 - › If the sign serves a continuing use, i.e., there are older signs that still have an active business and they need to change information such as the hours of operation

6.3 Do not over restore a historic wall sign.

- › Do not restore a historic wall sign to the point that all evidence of its age is lost.
- › Do not significantly re-paint a historic wall sign even if its appearance and form is recaptured.

Sign Installation on a Historic Building

When installing a new sign on a historic building, it is important to maintain the key architectural features of and minimize potential damage to the building.

6.4 Do not damage or obscure architectural details or other building features when installing a sign.

- › No sign or sign structure or support shall be placed onto or obscure or damage any significant architectural feature of a building, including but not limited to a window or a door frame, cornice, molding, ornamental feature, or unusual or fragile material.

6.5 A sign shall not obscure character-defining features of a historic building.

- › A sign shall be designed to integrate with the architectural features of a building, not distract from them.
- › No sign shall be painted onto any significant architectural feature, including but not limited to a wall, window or door frame, cornice, molding, ornamental feature, or unusual or fragile material.
- › No support for a sign shall extend above the cornice line of a building to which the sign is attached.



Mount a sign to fit within existing architectural features using the shape of the sign to help reinforce the horizontal lines of the building.



A sign shall be designed to integrate with the architectural features of a building, not distract from them. This sign remains subordinate to the architectural feature since much of the molding is still visible.



Do not damage or obscure architectural details or features when installing signs.

Design of New and Modified Signs



Using a symbol for a sign is permitted.



Use sign materials that are compatible with the architectural character and materials of the building.

Whether it is attached to a historic building or associated with new development, a new or modified sign shall exhibit qualities of style, permanence and compatibility with the natural and built environment. It shall also reflect the overall context of the building and surrounding area.

6.6 A sign shall be subordinate to the overall building composition.

- › Design a sign to be simple in character.
- › Locate a sign to emphasize design elements of the facade itself.
- › Mount a sign to fit within existing architectural features using the shape of the sign to help reinforce the horizontal lines of the building.
- › All sign types shall be subordinate to the building and to the street.

6.7 Sign materials shall be compatible with the architectural character and materials of the building.

- › Do not use reflective materials.
- › Use permanent, durable materials.

6.8 Use simple typeface design.

- › Do not use hard-to-read or overly intricate typefaces.
- › Use no more than two or three distinct typefaces on a sign.

6.9 Use colors that contribute to legibility and design integrity.

- › Limit the number of colors used on a sign. Generally, do not use more than three colors.
- › Vibrant colors are discouraged.

6.10 Using a symbol for a sign is permitted.

- › A symbol sign adds interest, can be read quickly and is remembered better than written words.

Design of Specific Sign Types

A variety of sign types may be permitted if each sign contributes to a sense of visual continuity and does not overwhelm the context.

AWNING SIGN

An awning/canopy sign occurs flat against the surface of the awning material.

6.11 An awning sign shall be compatible with the building.

- › Use colors and materials that are compatible with the overall color scheme of the facade.
- › See page 73 for additional awning standards.

INTERPRETIVE SIGN

An interpretive sign refers to a sign or group of signs that provide information to visitors on natural, cultural and historic resources or other pertinent information. An interpretive sign is usually erected by a non-profit organization or by a national, state or local government agency.

Interpretive signs shall comply with the design standards for the sign type that is the closest match. The standards below apply to a common freestanding sign type.

6.12 Design an interpretive sign to be simple in character.

- › The sign face shall be easily read and viewed by pedestrians.
- › An interpretive sign shall remain subordinate to its context.



An awning sign shall be compatible with the building.



Although these interpretive signs are outside of the Old Town district they're good examples of permitted interpretive signs. The signs are simple in character.

Design of Specific Sign Types



Mural content shall be appropriate to the district and its environs.

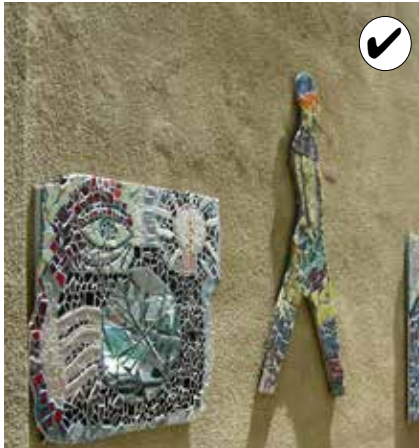

A mural shall complement the wall on which it is placed.



MURALS

A mural is a sign located on the side of the building whose content, reflects a cultural, historic or environmental event(s) or subject matter from the district.

6.13 Mural content shall be appropriate to the district and its environs.

- › The mural may not depict a commercial product brand name or symbolic logo that is currently available.

6.14 When used, a mural shall be incorporated as an element of the overall building design.

- › The mural shall complement the wall on which it is placed.
- › It shall not obscure key features of a historic building.

6.15 The application of a mural shall not damage historic materials.

- › The use of a mural that can be removed at a later date is permitted.
- › The application of a mural shall not damage the original building fabric. Generally, the hanging and/or anchoring of a mural should be reversible.
- › If a masonry wall is already painted, it may be acceptable to provide a painted mural with the approval of the review authority.

Design of Specific Sign Types

TENANT PANEL OR DIRECTORY SIGN

A tenant panel or directory sign displays the tenant name and location for a building containing multiple tenants.

6.16 Use a tenant panel or directory sign to consolidate small individual signs on a larger building.

- › Use a consolidated tenant panel or directory sign to help users find building tenants.
- › Locate a consolidated tenant panel or directory sign near a primary entrance on the first floor wall of a building.



Locate a small projecting sign near the business entrance, just above or to the side of the door.



Use a consolidated tenant panel or directory sign to help users find building tenants.

PROJECTING / UNDER-CANOPY SIGN

A projecting/under-canopy sign is attached perpendicular to the wall of a building or structure.

6.17 Design a bracket for a projecting/under-canopy sign to complement the sign composition.

6.18 Locate a projecting/under-canopy sign to relate to the building facade and entries.

- › Locate a small projecting/under-canopy sign near the business entrance, just above or to the side of the door.
- › Mount a larger projecting sign higher on the building, centered on the facade or positioned at the corner.



Design a bracket for a projecting sign to complement the sign composition.



The combination of the simple painted wall sign and the projecting sign are complementary to each other and permitted for this building type.

Design of Specific Sign Types



A wall sign is any sign attached parallel to the wall or surface of a building.



Place a wall sign to promote design compatibility among buildings.



Design a wall sign to minimize the depth of a sign panel or letters.

FLUSH WALL SIGN

A flush wall sign is any sign attached parallel to the wall or surface of a building.

6.19 Place a flush wall sign to promote design compatibility among buildings.

- › Place a wall sign to align with other signs on nearby buildings.

6.20 Place a flush wall sign close to the building wall.

- › Design a wall sign to minimize the depth of a sign panel or letters.
- › Design a wall sign to fit within, rather than forward of, the fascia or other architectural details of a building.

Design of Specific Sign Types

WINDOW AND DOOR SIGN

A window sign is any sign, picture, symbol, or combination thereof, designed to communicate information about an activity, business, commodity, event, sale or service that is placed inside within one foot of the inside window pane or upon the windowpanes or glass and which is visible from the exterior of the window.

6.21 Design a window sign to minimize the amount of window covered.

- › Scale and position a window sign to preserve transparency at the sidewalk edge.



Design a window sign to minimize the amount of window covered.



Design a door sign to minimize the amount of window covered.

ILLUMINATION



Direct lighting towards a sign from an external, shielded lamp.

KIOSKS

A sign kiosk is typically a series of configured sign panels.

6.22A sign kiosk is prohibited within the district.

- › Unless used by the city for wayfinding or for interpretive information.

OTHER SIGN TYPES

All sign types that are not mentioned here, but which are permitted in the district, shall adhere to the standards in “Design of New and Modified Signs” in this chapter.

ILLUMINATION

6.23 Include a compatible, shielded light source to illuminate a sign.

- › Direct lighting towards a sign from an external, shielded lamp.
- › Do not overpower the building or street edge with lighting.
- › Use a warm light, similar to daylight.
- › If halo lighting is used to accentuate a sign or building, locate the light source so that it is not visible.
- › A sign shall be illuminated from an indirect light source.

6.24 If internal illumination is used, it shall be designed to be subordinate to the overall building composition.

- › Internal illumination of an entire sign panel is prohibited. If internal illumination is used, a system that backlights text only is permitted.
- › Internal illumination of an awning is prohibited; however, lights may be concealed in the underside of a canopy.

APPENDIX



Historic Architectural Styles

Nineteenth-Century Commercial

Most nineteenth-century commercial structures are usually considered Italianate in style. However, many buildings contain a variety of detailing not associated with Italianate. These commercial buildings have been divided into four categories: the single storefront, generally twenty-five-feet wide with one entrance; the double storefront, with a width of fifty feet or more and two or three entrances; the corner building which may have entrances on two sides and sometimes a diagonal corner entrance; and the commercial block which generally covers a large area with multiple entrances.

Most nineteenth-century commercial buildings are two or three stories in height, with a flat roof and a variety of ornamental detailing. The “textbook” storefront has a recessed central entrance flanked by large display windows with kickplates, window and door transoms. The primary or roofline cornice is often bracketed with parapets, finials, or simple decorative panels. There is sometimes a secondary cornice separating the first two stories, which sometimes repeat the pattern of the upper cornice. Windows on the upper stories are generally smaller than the display windows on the street level and are usually decorated with molded surrounds, radiating voussoirs, or plain stone lintels.

Some of the most ornate nineteenth-century commercial structures feature cast iron façades. These had Italianate features particularly at the cornice. Richardsonian elements are also evident on some of these structures. The key to distinguishing a nineteenth-century building is the predominately glass storefront and smaller windows on the upper stories. These buildings are usually retail, offices, and hotel space.



Common elements:

- » cast iron façade
- » kickplate
- » window transom
- » lintel
- » radiating voussoirs
- » bracketed cornice
- » secondary cornice
- » door transom
- » recessed entry



Note:

These style descriptions are taken from the History Colorado web link at:

<http://www.historycolorado.org/archaeologists/colorados-historic-architecture-engineering-web-guide>

Early Twentieth-Century Commercial



Early Twentieth-Century Commercial structures are generally one to five stories, with flat or slightly pitched roofs. Often constructed of blond or light colored brick, these buildings have very little ornamentation other than some decorative brickwork along the cornice or parapet. In some of the smaller towns, 20th century commercial structures retain some elements of 19th century commercial structures.

The clear glass transoms of the nineteenth century has largely been replaced by translucent prismatic glass. Some storefront entrances of this period are flush with the façade. Others, particularly in retail establishments, feature deep, nearly façade-wide recesses that allow shoppers to examine window displays out of the sidewalk traffic.

Common elements:

- » recessed or flush entrance
- » translucent window transom
- » door transom
- » corbelled cornice
- » decorative brickwork
- » parapet

Classical Revival

Classical Revival signaled a return to the classical forms of Greece and Rome following the elaborately decorated and picturesque styles of the Victorian period. Dating from the late 1890s through 1920, Classical Revival represents a more subdued expression than the ostentatious or grandiose Beaux Arts style and is evident mainly on large institutional buildings in Colorado.

Characteristics of Classical Revival include colossal porticos, large columns, pilasters, pedimented windows, and domes. The buildings are generally masonry structures of monumental proportions, using terra cotta, brick, and stone materials.

Often, classical details such as large column porticos are combined with Colonial Revival elements on residences, leading to some confusion as to the style. To avoid this problem, residences with classical elements are considered examples of Colonial Revival and only large institutional buildings with classical details are classified as Classical Revival.

Common elements:

- » large columns
- » dome
- » portico
- » pediments
- » pilasters
- » Ionic columns
- » attic story
- » dentils
- » classical frieze

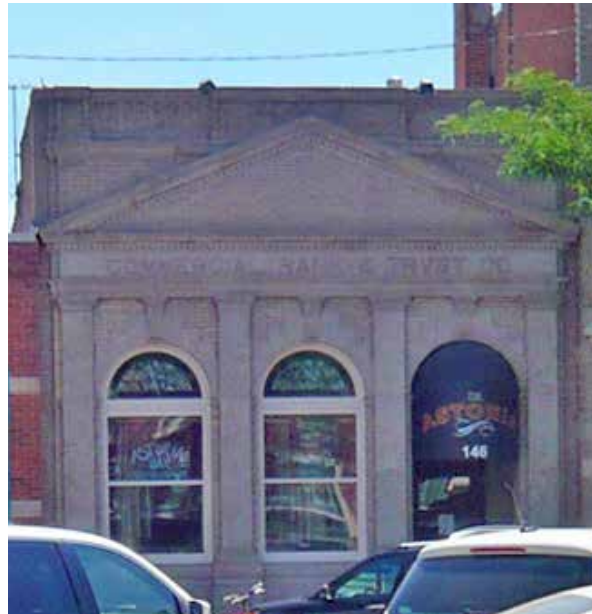



Richardsonian Romanesque

The chief characteristic of the Romanesque Revival style is the semicircular arch, used for window and door openings as well as a decorative element along the corbel table. Other characteristics include an archivolt of compound arches and square towers of different heights and various roof shapes. A crenellated tower parapet is common.

Richardsonian Romanesque, named after architect Henry Hobson Richardson (1838-1886), is characterized by heavy, rock-faced stone, round masonry arches, contrasting colors, transom windows arranged in ribbon-like patterns, square towers, and sparse fenestration. Most of the Richardsonian Romanesque structures are variations of the style, employing selected Richardsonian elements.

Common elements:

- » semicircular arch
- » corbel table
- » archivolt
- » compound arch
- » square tower
- » rock-faced stone
- » round masonry arches
- » contrasting colors
- » transom windows in ribbon pattern

Art Deco

Art Deco is characterized by an angular, linear composition, stepped or set-back facade, and polychromatic materials. Popular during the 1930s and 1940s, apartment buildings, school, and commercial buildings all over Colorado exhibit elements of this style. Geometric forms are the most common stylistic expressions. Broken cornice lines, low relief geometrical designs, spandrel panels, architectural sculptures, polychromatic materials and a vertical emphasis are also characteristic. Decorative façade elements include chevrons, zigzags, stylized floral and geometric motifs.

Common elements:

- » linear composition
- » polychromatic material
- » stepped fronts
- » broken cornice line
- » geometric forms

Moderne

Moderne, also called Art Moderne or Streamline Moderne, saw popularity in the 1930s and early 1940s. Restrained Moderne bridged the gap between the flamboyant Art Deco and the functional International Style of the 1940s and 1950s. Smooth stucco exteriors, rounded corners, and curved metal canopies all gave the impression of a sleek and modern building. Portholes, taken directly from the luxury liners of the time period, found their way onto buildings, most often applied to garages, bus terminals, and airports.

Construction slowed down significantly with the onset of World War II and the restrictions placed on various materials. As Moderne faded, simple and stark buildings in the International Style emerged, reflecting the sparse times in which they were constructed.

Common elements:

- » stucco exterior
- » flat roof
- » horizontal emphasis
- » rounded corners
- » smooth surfaces
- » glass block
- » speed lines
- » little ornamentation
- » curved metal hoods
- » porthole opening
- » vertical emphasis



This structure, originally an Italianate commercial building, was remodeled in 1936 in the Art Deco Style.

Factory/Warehouse



Warehouse buildings are often composed of large, rectangular masses. The primary material is brick with accents of stone masonry, wood or metal. Detailing was usually simple with decorative features including door surrounds, window hoods, modillions, keystones and elaborate cornices. Flat roofs are most common; however, gable roofs screened by parapet walls are also seen. Double-hung windows with 1/1, 2/2 and 4/4 patterns are characteristic. Raised loading docks for handling goods are common; some project from the facade while others are inset behind the building plane. Loading bay doors and openings were typically rectangular. Metal or wood canopies sheltering the loading dock are also typical.

Common elements:

- » simple form
- » flat roof
- » loading docks at rear
- » aligned windows