



ITEM NO 1
MEETING DATE Mar. 28, 2016
STAFF Clay Frickey

ADMINISTRATIVE HEARING OFFICER

STAFF REPORT

PROJECT: Harmony Cottages, PDP150030

APPLICANT: Russ Lee
Ripley Design, Inc.
419 Canyon Ave.
Suite 200
Fort Collins, CO 80524

OWNERS: Harmony Limited, LLC
PO Box 271519
Fort Collins, CO 80527

PROJECT DESCRIPTION:

This is a request for a Project Development Plan for Habitat for Humanity to construct 44 two-family and 4 single-family dwelling units on a 4.45 acre site located southeast of the intersection of Harmony Road and Taft Hill Road. The LMN zoning district allows twelve dwelling units per gross acre of land for affordable housing projects. Habitat for Humanity seeks to provide housing for people whose income is between 35% and 60% of the Fort Collins average median income (AMI) and therefore qualifies as an affordable housing project. With 48 total dwelling units, the proposed density is 10.79 dwelling units per acre. This site is located in the LMN (Low Density Mixed Use Neighborhood District).

RECOMMENDATION: Staff recommends approval of Harmony Cottages PDP150030 with conditions.

EXECUTIVE SUMMARY:

Staff finds the proposed Harmony Cottages Project Development Plan complies with the applicable requirements of the City of Fort Collins Land Use Code (LUC), more specifically:

- The Project Development Plan complies with the process located in Division 2.2 – Common Development Review Procedures for Development Applications of Article 2 – Administration.

- The Modification of Standard to Section 3.5.2(E)(1) – setback from arterial streets - that is proposed with this Project Development Plan meets the applicable requirements of Section 2.8.2(H), in that the granting of the Modification would not be detrimental to the public good, the plan will promote the general purpose of the standard for which the modification is requested equally or better than would a plan which complies with the standard for which a modification is requested, and the granting of a modification from the strict application of this standard would, without impairing the intent and purpose of this Land Use Code, substantially alleviate an existing, defined and described problem of city-wide concern.
- The Project Development Plan complies with relevant standards of Article 3 – General Development Standards.
- The Project Development Plan complies with relevant standards located in Division 4.5, Low Density Mixed-Use Neighborhood (LMN) of Article 4 – Districts.

While the proposed plan complies with the applicable requirements of the City of Fort Collins Land Use Code, the site plan currently does not match up with the proposed civil engineering documents and plat. Staff recommends approval of the proposed plan with the condition that all documents match at the time of recordation.

COMMENTS:

1. Background

The property was annexed into the City as part of the Horsetooth – Harmony West Annexation on June 3, 1980. In 2005, Habitat for Humanity pursued a project on the property called Innovation Island. Innovation Island was a development that separated the 4.45 acres of land into two lots. As proposed, Innovation Island would have consisted of 27 multi-family units with 61 parking spaces on 3.16 acres on Lot 1. Lot 2 was to be developed as multi-family residential or commercial as part of a later phase of development. The Innovation Island PDP sought entitlement for the development of Lot 1. The Innovation Island PDP was approved by the Planning & Zoning Board on November 17, 2005. The decision of the Planning & Zoning Board was appealed to City Council on January 17, 2006. City Council upheld the Planning & Zoning Board's decision. Despite gaining this approval, the Innovation Island development did not move forward and the PDP lapsed in 2009.

The surrounding zoning and land uses are as follows:

Direction	Zone District	Existing Land Uses
North	County	Single-family detached residential, multi-family
South	Low Density Residential (RL)	Single-family detached residential
East	Low Density Residential (RL)	Single-family detached residential
West	County	Single-family detached residential, gas station and convenience store, mobile home park

Below is a zoning and site vicinity map.

Figure 1: Harmony Cottages Zoning & Site Vicinity Map



2. **Compliance with Section 2.8.2(H) of the Land Use Code - Modification of Standards**

Modification Description:

The applicant requests a Modification to Section 3.5.2(E)(1) – *Setback from Arterial Streets* to set the proposed buildings back from Harmony Road and Taft Hill Road 15 feet where 30 feet is required.

Land Use Code Standard Proposed to be Modified (areas underlined and bolded for emphasis):

Land Use Code 3.5.2(E)(1):

The minimum setback of every residential building and of every detached accessory building that is incidental to the residential building **shall be thirty (30) feet from any arterial street right-of-way, except for those buildings regulated by Section 3.8.30 of this Code, which buildings must comply with the setback regulations set forth in Section 3.8.30.**

Land Use Code Modification Criteria:

“The decision maker may grant a modification of standards only if it finds that the granting of the modification would not be detrimental to the public good, and that:

(1) the plan as submitted will promote the general purpose of the standard for which the modification is requested equally well or better than would a plan which complies with the standard for which a modification is requested; or

(2) the granting of a modification from the strict application of any standard would, without impairing the intent and purpose of this Land Use Code, substantially alleviate an existing, defined and described problem of city-wide concern or would result in a substantial benefit to the city by reason of the fact that the proposed project would substantially address an important community need specifically and expressly defined and described in the city’s Comprehensive Plan or in an adopted policy, ordinance or resolution of the City Council, and the strict application of such a standard would render the project practically infeasible; or

(3) by reason of exceptional physical conditions or other extraordinary and exceptional situations, unique to such property, including, but not limited to, physical conditions such as exceptional narrowness, shallowness or topography, or physical conditions which hinder the owner’s ability to install a solar energy system, the strict application of the standard sought to be modified would result

in unusual and exceptional practical difficulties, or exceptional or undue hardship upon the owner of such property, provided that such difficulties or hardship are not caused by the act or omission of the applicant; or

(4) the plan as submitted will not diverge from the standards of the Land Use Code that are authorized by this Division to be modified except in a nominal, inconsequential way when considered from the perspective of the entire development plan, and will continue to advance the purposes of the Land Use Code as contained in Section 1.2.2.

Any finding made under subparagraph (1), (2), (3) or (4) above shall be supported by specific findings showing how the plan, as submitted, meets the requirements and criteria of said subparagraph (1), (2), (3) or (4).

Summary of Applicant’s Justification:

The applicant requests that the Modification be approved and provides the following justification based upon Criterion 1 (proposal is equal or better than provisions in the Land Use Code):

Applicant’s Justification for Criterion 1:

- *In order to mitigate the proximity of the single family attached houses to the Harmony and Taft Hill road ways, the applicant is proposing to more than double the amount of landscape required along the street scape. The code would require 17 trees along Harmony Road and 8 trees along Taft Hill. In order to provide a visual buffer from the houses and the roads, the applicant is proposing 44 trees along Harmony and 16 along Taft Hill. That would more than double the required landscape.*
- *The existing right-of-ways along Harmony and Taft Hill are also larger than the City standard providing a greater distance from the homes and the road than would be typical in the City. The typical park way along a 4 lane arterial is 16’ (the area between the back walk and the road). The park way along Harmony is 24’ and the park way along Taft Hill it is 55’. With a 30’ set back along an arterial and a typical 16’ parkway, the code would require single family homes to be set back 46’ from the arterial road. The current design is close to meeting or exceeding that dimension. The homes along Harmony will be setback from the road between 39’ and 44’. That is only 2’-7’ closer than the current standards would require. The homes along Taft Hill are set back 72’ from the road way exceeding the required 46’ set back by 26’.*
- *Lastly, if the units along Harmony and Taft Hill were a 3-plex unit rather than a duplex, the code would allow the homes to be 15’ from the right of way matching the closest set back shown on the plans.*

Applicant's Justification for Criterion 2:

Development of the Harmony Cottages project would result in a substantial benefit to the City because the proposed community would address the need for affordable housing as expressed in City Plan. City Plan contains overarching policy statements that promote balanced and integrated living patterns. Topics addressed include the goal of a mix of housing types in all City sectors. Additionally, affordable housing is encouraged to be dispersed throughout the City.

The City also has an Affordable Housing Strategic Plan, which establishes priorities and strategies for the City's affordable housing programs and informs the Consolidated Plan and Annual Action Plans required by HUD. The most recent plan (2015) identifies four priorities to address affordable housing needs:

- Increase the inventory of affordable units*
- Preserve existing affordable housing units*
- Increase housing and facilities for people with special needs*

To meet the definition of Affordable Housing in the City of Fort Collins, 10% of units must be set-aside for households earning less than 80% of Area Median Income (AMI) adjusted for household size. The Applicant is proposing to set aside 100% of the dwelling units for households earning less than 60% of AMI. In addition the properties will be deed income restricted for 20 years. The first homeowner will have to qualify earning between 35-60% AMI and then, if resold, the new buyer would need to earn less than 80% AMI.

Staff Finding:

Staff finds that the request for a Modification of Standard to section 3.5.2(E)(1) is justified by the applicable standards in 2.8.2(H)(1) and 2.8.2(H)(2).

- A. The granting of the Modification would not be detrimental to the public good;
- B. The project design satisfies 2.8.2(H)(1): *the plan as submitted will promote the general purpose of the standard for which the modification is requested equally well or better than would a plan which complies with the standard for which a modification is requested;* and
- C. The project design satisfies 2.8.2(H)(2): *the granting of a modification from the strict application of any standard would, without impairing the intent and purpose of this Land Use Code, substantially alleviate an existing, defined and described problem of city-wide concern or would result in a substantial benefit to the city by reason of the fact that the proposed project would substantially address an important community need specifically and expressly*

defined and described in the City's Comprehensive Plan or in an adopted policy, ordinance or resolution of the City Council, and the strict application of such a standard would render the project practically infeasible

Staff Finding for Criterion 1:

Staff finds that the proposed plan meets the intent of the Code section equal to or better than would a plan that complies with the standard for which this modification is requested. The purpose of the setback standards for single-family houses along arterial streets is to provide safety for residents and minimize the impact of road noise. Two factors provide increased safety and minimize road noise in lieu of the typical 30' setback. One is the increased landscaping provided along both Harmony Road and Taft Hill Road. The proposed landscape plan shows double the landscaping required along Taft Hill Road and more than double the required landscaping required along Harmony Road. The increased landscaping is complemented by a white picket fence to further delineate the edge of the lots.

The other factor that aids the safety and minimizes noise from arterial roads is the distance of the buildings from the nearest traffic lanes on Harmony Road and Taft Hill Road. Harmony Road is unique in that the parkway abutting this parcel is 24 feet wide as opposed to the typical 16 foot parkway along most arterials. This means the buildings of this development are 8 feet further away from the nearest travel lane than is typical. While this means some buildings are still 7 feet closer to the nearest travel lane than is typical, the additional landscaping and fencing reduces the impact of Harmony Road on the development. The buildings are even further away from the nearest travel lane on Taft Hill Road since Taft Hill has yet to be widened. According to the City's latest Capital Improvement Plan, the widening of Taft Hill Road between the Growth Management Area boundary and Harmony Road would cost approximately \$8.5 million. This project is identified as a long-term or forecasted need. Like many of the projects identified in the Capital Improvement Plan, the widening of Taft Hill Road from the Growth Management Area boundary is unfunded. As such, it is unclear at this time when Taft Hill Road will be widened. In its current condition, the buildings are 72' away from the nearest travel lane on Taft Hill Road, which vastly exceeds the typical 46 feet when accounting for the setback, sidewalk, and parkway seen on most arterials.

Staff also finds that the proposal as shown with single-family attached units with a decreased setback to be equal to or better than a plan that would show multi-

family units with a 15 foot setback. Multi-family buildings only require a 15 foot setback from arterial streets per Land Use Code section 3.8.30(E)(3), which supersedes the standard outlined in 3.5.2(E)(1). The proposed plan could comply with the minimum setback standard by changing the unit type to triplexes. Staff finds that a plan featuring triplexes with a 15 foot setback would be inferior to the current plan. The current plan allows each unit to have more access to air and light due to the required side yard setbacks between each duplex. In a triplex configuration, the middle unit would likely have less access to air and light and would result in a less livable and desirable unit for potential home owners. The scale of duplexes also more closely matches the existing character of the neighborhood.

In summary, staff finds the proposed site plan is equal to or better than a plan that meets Land Use Code section 3.5.2(E)(1). The proposed plan addresses safety and noise issues through enhanced landscaping and fencing. The proposed buildings will also be further away from the nearest travel lanes along Harmony Road and Taft Hill road than usual due to the unique parkway strips along these roadways. The proposed site plan will also allow for more livable units that are more compatible with the surrounding area than would a similar plan featuring triplexes.

Staff Finding for Criterion 2:

Staff finds the proposed development meets goals identified in City Plan, Fort Collins' comprehensive plan, as well as the Affordable Housing Strategic Plan, which was adopted by City Council unanimously in August 2015.

City Plan has numerous principles and policy objectives that target an increased supply of affordable housing in Fort Collins. Some of these policies include but are not limited to:

Principle LIV 7: A variety of housing types and densities for all income levels shall be available throughout the Growth Management Area.

Policy LIV 7.4 – Maximize Land for Residential Development

Permit residential development in most neighborhoods and districts in order to maximize the potential land available for development of housing and thereby positively influence housing affordability.

Principle LIV 8: *The City will encourage the creation and expansion of affordable housing opportunities and preservation of the existing affordable housing supply.*

Policy LIV 8.1 – Support Affordable Housing Programs

Support the development and provision of affordable housing in the community by maintaining and allocating funding for affordable housing services and programs including management of a competitive process for federal and local funding, development incentives, homebuyer assistance, and the Land Bank program.

The recently adopted Affordable Housing Strategic Plan also aims to increase the amount of affordable housing in Fort Collins. One of the overarching goals of the Affordable Housing Strategic Plan is that publicly assisted affordable housing will consist of 10% of the housing stock by 2040. To reach this overall goal, the City must meet a short-term goal of having publicly assisted affordable housing consist of 6% of the housing stock by 2020. To reach this goal with the projected growth of the community, 94 affordable, owner-occupied units would need to be built by 2020. This project would help fulfill a substantial portion of this goal.

Staff finds that the modification request for relief from the 30' setback requirement from arterial streets is justified due to the proposed plan's alignment with an important community need expressed within City Plan and the Affordable Housing Strategic Plan.

3. Compliance with Article 3 of the Land Use Code – General Development Standards:

The project complies with all applicable General Development Standards as follows:

A. *Section 3.2.1(D) – Tree Planting Standards*

All developments must establish groves and belts of trees along all city streets, in and around parking lots, and in all landscape areas that are located within 50 feet of any building or structure in order to establish at least a partial urban tree canopy. The proposed landscape plan shows trees that line the private drive that runs through the development that will provide a tree canopy along the street. Each shared green space between the units feature trees that will further enhance the tree canopy on the site.

B. *Section 3.2.1(D)(2) – Street Trees*

Developments that front on streets with a landscape parkway must provide canopy shade trees at 30-40 foot spacing in the center of such parkway areas. The proposed landscape plan shows canopy shade trees along Harmony Road and Taft Hill Road with 40 foot spacing between each canopy shade tree.

C. *Section 3.2.1(D)(3) – Minimum Species Diversity*

To prevent uniform insect or disease susceptibility and eventual uniform senescence on a development site or in the adjacent area or the district, species diversity is required and extensive monocultures are prohibited. The maximum percentage of any one species when there are 60 or more trees on site is 15%. No species consists of more than 15% of the overall amount of trees provided.

D. *Section 3.2.1(D)(4) – Tree Species and Minimum Sizes*

All trees provided must meet the minimum sizes as follows:

<i>Type</i>	<i>Minimum Size</i>
Canopy Shade Tree	2.0" caliper balled and burlapped or equivalent
Evergreen Tree	6.0' height balled and burlapped or equivalent
Ornamental Tree	1.5" caliper balled and burlapped or equivalent
Shrubs	5 gallon or adequate size consistent with design intent
Canopy Shad Tree as a street tree on a Residential Local Street Only	1.25" caliper container or equivalent

The trees shown on the landscape all meet these minimum requirements.

E. *Section 3.2.1(E)(3) – Water Conservation*

All landscape plans must be designed to incorporate water conservation materials and techniques in order to meet the Xeriscape principals established in the Land Use Code. Total annual water use shall not exceed 15 gallons/square foot over the site. The landscape plan meets

the Xeriscape principals in the Land Use Code and has an annual water use of 12.54 gallons/square foot over the site.

F. *Section 3.2.2(C)(1) – Safety Considerations*

To the maximum extent feasible, pedestrians shall be separated from vehicles and bicycles. The proposed development will have an extensive system of sidewalks separated from the roadway by a curb. These walkways allow pedestrians to move within the site without encountering vehicles or bicycles.

G. *Section 3.2.2(C)(5) – Walkways*

Walkways must be located and aligned to directly and continuously connect areas or point of pedestrian origin and destination. Each walkway shown on the proposed site plan connects to the entry of each duplex and single-family home. These walkways connect to the street like private drive that runs through the site. All of the walkways end up leading to the sidewalks on Harmony Road and Taft Hill Road.

H. *Section 3.2.2(C)(6) – Direct On-Site Access to Pedestrian and Bicycle Destinations*

Pedestrian and bicycle facilities provided on site must connect to or allow for direct connections to major pedestrian and bicycle destinations. The sidewalk network connects to the sidewalks on Harmony Road and Taft Hill Road, which provide direct connections to major destinations.

I. *Section 3.2.2(C)(8) – Transportation Impact Study*

A Transportation Impact Study is required for developments that could have an impact on the traffic conditions surrounding the development. The applicant supplied a Transportation Impact Study in accordance with the City's guidelines.

J. *Section 3.2.2(D) – Access and Parking Lot Requirements*

The proposal meets the requirements outlined in Land Use Code section 3.2.2(D) including the separation of vehicles and pedestrians, unobstructed vehicle access, location of off-street parking areas, pavement material, and lighting.

K. *Section 3.2.2(J) – Setbacks*

The minimum setbacks for a vehicle use area are 15 feet along an arterial street and 5 feet along a lot line. All of the vehicle use areas meet these minimum requirements.

L. *Section 3.2.2(K) – Parking Lots – Required Number of Off-Street Spaces for Type of Use*

The table below shows the amount of off-street parking spaces required and the amount provided by unit type.

Table 1 - Off-Street Parking Summary

Unit Type	# of Units	Parking Required	Parking Provided
Duplex, 2-bed	13	23	23
Duplex, 3-bed	26	52	52
Duplex, 4-bed	5	15	15
Single-family detached	4	8	8
Total	48	98	98

M. *Section 3.2.3 – Solar Access, Orientation, Shading*

All development shall be designed throughout to accommodate active and/or passive solar installations to the extent reasonably feasible while minimizing the casting of shadows onto adjacent developments. The architectural elevations show solar panels on the roofs of each duplex and are located to minimize casting shadows on the neighborhood to the south.

N. *Section 3.2.4 – Site Lighting*

The proposed lighting plan is consistent with the requirements of the Land Use Code in regards to the general standard, lighting levels and design standards.

O. *Section 3.3.1(B) – Lots*

No lot in a subdivision shall have less area than required under the applicable zoning requirements. Each lot must also have vehicular access

to a public street. All lots meet the minimum dimensional standards outlined in Section 4.5 of the Land Use Code.

P. *Section 3.5.1 – Building and Project Compatibility*

New developments shall be compatible with the established architectural character of the area. This includes using similar materials, buildings that are of a similar size, height, bulk, mass, and scale, and minimizing the infringement on adjacent property owners' privacy.

The neighborhood immediately to the south of this development consists of a mix of one and two-story single-family detached dwellings. Most of the houses consist of wood siding with brick accents and pitched roofs. All of the duplexes have attached garages. Some of the houses also feature small front porches. The proposed architecture for Harmony Cottages is one and two-story structures with siding and pitched roof forms. Each duplex will also contain covered porches. While the adjacent subdivision does not contain any duplexes, the duplexes as part of this proposal are designed to look like single-family houses with distinct roof forms for each side of the duplex. The duplexes are also comparably sized to the single-family houses in the adjacent. All of the buildings along the southern property line are also oriented to minimize privacy issues for adjacent property owners. These qualities work in concert to create a development that will be compatible with the existing neighborhoods.

The proposed site and landscape plan also show extra attention to buffering from adjacent uses. While the proposed residential use is consistent with the adjacent residential uses, the proposed development is denser than the surrounding neighborhoods. To improve the transition between the proposed development and adjacent neighborhood to the south, the landscape plan shows groves of trees that act as a buffer. These tree groves provide visual relief to the adjacent neighborhood and soften the transition from duplexes to single-family detached homes.

Q. *Section 3.5.2(D) – Relationship of Dwellings to Streets and Parking*

Every front door shall face the adjacent street to the extent reasonably feasible. Alternatively, front doors may face onto a major walkway spine as long as the front door is no more than 350 feet from a street sidewalk. Most of the front doors face onto a shared green space with walkways that

connect to the sidewalk on the “street-like” private drive that serves the development. None of these front doors are more than 350 feet from the nearest street sidewalk. Lots 14-21 and 41-48 have front doors that connect directly to the sidewalks along Harmony Road and Taft Hill Road, respectively.

R. *Section 3.5.2(E)(3) – Side and Rear Yard Setbacks*

For residential buildings, the minimum side yard setback is 5 feet and the minimum rear yard setback is 8 feet. Each building complies with the 5 foot side yard setback and the 8 foot rear yard setback.

S. *Section 3.5.2(F) – Garage Doors*

Garage doors should be integrated into the development to prevent the streetscape from being dominated by protruding garage doors. The proposed garage doors face an alley and have windows so that the garage appears to be a part of the living portion of the house.

T. *Section 3.6.6 – Emergency Access*

All proposed developments shall provide adequate access for emergency vehicles and for those persons rendering fire protection and emergency services. The proposed development’s emergency access plan has gained preliminary approval from Poudre Fire Authority for meeting all applicable code requirements.

4. **Compliance with Article 4 of the Land Use Code – Division 4.5, Low Density Mixed-Use Neighborhood (LMN):**

The project complies with all applicable Article 4 standards as follows:

A. *Section 4.5(B)(2)(a) – Permitted Uses*

The proposed use, single-family attached dwellings, is permitted in the LMN zone district and is consistent with the district’s intent to be a setting for a predominance of low density housing.

B. *Section 4.5(D)(1)(b) – Density*

The maximum density of any development shall be 9 dwelling units per acre except for affordable housing projects containing 10 acres or less,

which can have a density of 12 dwelling units per acre. The proposed development is a certified affordable housing development with a proposed density of 10.79 dwelling units per acre on a 4.45 acre site.

C. *Section 4.5(E)(3) – Maximum Residential Building Height*

The maximum height for single-family and two-family structures is two and a half stories. All of the proposed buildings will be two stories or one story in height.

5. Public Outreach Summary

As part of this project, the applicant conducted two neighborhood meetings. The first meeting was held December 3, 2015 at Global Village Academy. This meeting was structured as an open house to gather information about the proposed development, the Habitat for Humanity program, and the process the proposed development would go through. The applicant had not yet submitted a formal development review proposal to the City at the time of the neighborhood meeting. 32 neighborhood members attended their meeting and provided feedback on the preliminary proposal. Due to the number of concerns raised at the first neighborhood meeting, the applicant coordinated a second neighborhood meeting in collaboration with an HOA adjacent to the development site. This meeting was held on February 18th, 2016. Over 80 neighborhood members attended the second meeting. The structure of the second meeting was a more traditional neighborhood meeting format where the applicant and City representatives gave presentations on the project and the development review process followed by a question and answer period. Neighbors raised similar concerns at both neighborhood meetings. Most of the concerns fell in the following categories:

- Overall density of the project is too high
- Increased traffic due to the development on Taft Hill and Harmony will negatively impact current residents of the area
- Concern about potential cut-through traffic through the existing neighborhoods to the south
- Desire for additional access point on Taft Hill Road so that there are two entrances and exits for the development
- Worried about the development's impact on home values
- Safety concerns for kids that will be walking to nearby schools

6. Findings of Fact/Conclusion:

In evaluating the request for the Harmony Cottages Project Development Plan, Staff makes the following findings of fact:

- A. The Modification of Standard to Section 3.5.2(E)(1) that is proposed with this Project Development Plan meets the applicable requirements of Section 2.8.2(H), in that the granting of the Modification would not be detrimental to the public good, the plan will promote the general purpose of the standard for which the modification is requested equally or better than would a plan which complies with the standard for which a modification is requested, and the granting of a modification from the strict application of this standard would, without impairing the intent and purpose of this Land Use Code, substantially alleviate an existing, defined and described problem of city-wide concern.
- B. The Project Development Plan complies with relevant standards located in Article 3 – General Development Standards.
- C. The Project Development Plan complies with relevant standards located in Division 4.5, Low Density Mixed-Use Neighborhood (LMN) of Article 4 – Districts.

While the proposed plan complies with the applicable requirements of the City of Fort Collins Land Use Code, the site plan currently does not match up with the proposed civil engineering documents and plat. Staff recommends approval of the proposed plan with the condition that all documents match at the time of recordation.

RECOMMENDATION:

Staff recommends approval of Harmony Cottages, PDP150030 with the condition that the civil engineering documents and plat match the proposed site plan at the time of recordation.

ATTACHMENTS:

- 1. Zoning & Site Vicinity Map
- 2. Statement of Planning Objectives
- 3. Harmony Cottages Subdivision Plat
- 4. Harmony Cottages Planning Document Set (includes site plan, landscape plan, photometric plan, and elevations)
- 5. Modification Request

6. Traffic Impact Analysis
7. Geotechnical Report
8. Drainage Report
9. Harmony Cottages Utility Plan Set
10. Neighborhood meeting summary – December 3, 2015
11. Neighborhood meeting summary – February 18, 2016
12. Habitat for Humanity Program Description

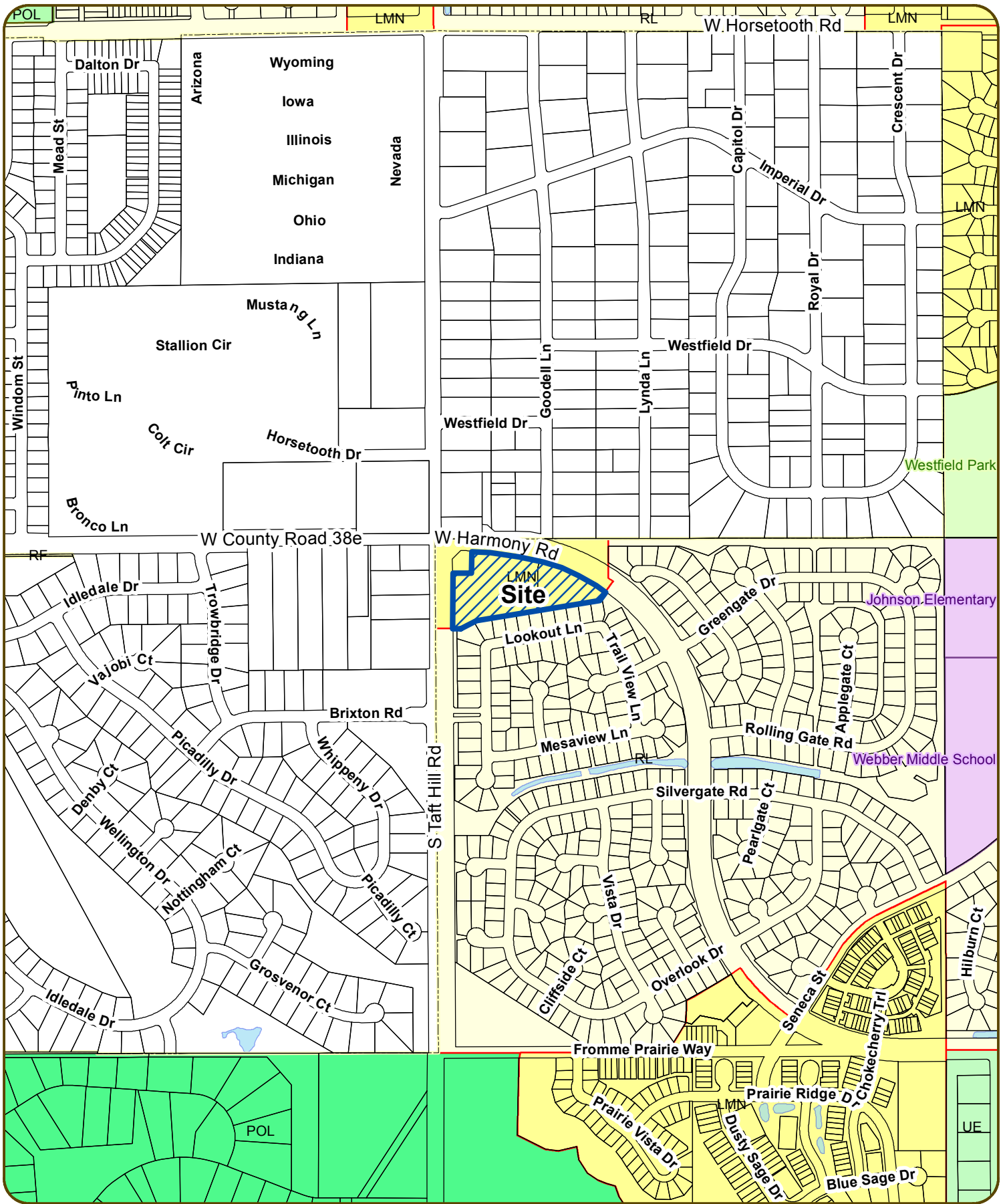

1 inch = 667 feet

Harmony Cottages Vicinity Map





land planning ■ landscape architecture ■ urban design ■ entitlement

December 15, 2015

Planning Objectives

Harmony Cottages PDP

The Applicant, Habitat for Humanity, is proposing to construct 44 single-family and 4 two-family dwelling units on 4.45 acres located southeast of the intersection of Harmony Road and Taft Hill Road. The property is zoned Low Density Mixed Use Neighborhood District (LMN). There is a small parcel of land located on the corner that is owned by the South Fort Collins Loveland Water District that is not part of the project. A County residential development known as Westfield is located to the north and Woodridge Subdivision is immediately adjacent to the property on the south.

In 2005 Habitat for Humanity proposed a project called Innovation Island, a multi-family and commercial development located on this site. The project was approved by the Planning and Zoning Board and the City Council upheld the approval in a subsequent Appeal process, however, the project as proposed turned out to be financially infeasible. Additional dwelling units were required to make the project work financially.

The LMN zoning allows twelve dwelling units per gross acre of land for affordable housing projects. Habitat seeks to provide housing for people whose income is between 35% and 60% of the Fort Collins average median income (AMI) and therefore qualifies as an affordable housing project. With 48 total dwelling units, the proposed density is 10.79 dwelling units per acre.

Access is from Harmony Road via a street-like private drive located approximately 581 feet east of Taft Hill Road with an emergency access located 201 feet east of Taft Hill Road. All the dwelling units are alley-loaded and most of them face on to green courts or park space. Four buildings face Harmony Road and four buildings face Taft Hill Road. In both cases additional landscaping has been provided to insure that these units are adequately buffered from the arterial streets. On-street parking is proposed along the south side of the street-like private drive and the alley courts provide access to single car garages. The alley courts also include an additional parking space for each unit. Trash collection will be provided for individual units accessed from the alleys.

There are existing public street sidewalks along both Taft Hill Road and Harmony Road. Since the units along Taft Hill Road are setback approximately 60 feet from the public

Thinking outside of the box for over two decades.

419 Canyon Ave. Suite 200 ■ Fort Collins, CO 80521 ■ tel. 970.224.5828 ■ fax 970.224.1662
www.ripleydesigninc.com

sidewalk, an additional sidewalk is proposed in front of the dwelling units. This private walk in turn connects to the public street sidewalk at both the north and south edges of the property. There are several connections to the public street sidewalk along Harmony Road as well.

The green courts are defined by sidewalks making them attractive and readily accessible for residents and visitors. The project is defined by picket fencing along both Harmony and Taft Hill Road street frontages. Additional picket fencing is located internal to the site partially enclosing green courts. A bus stop is located at the main entrance to the project and community mail boxes are located nearby the entrance as well. A private park space with a small playground is centrally located and shared by all residents.

The site drains to the south with storm water collected in a swale that parallels the south property line. The drainage swale and associated landscaping provide water quality treatment for the storm water before it leaves the site at the southeast corner and enters the City's storm water system. The area will be seeded with native grasses and provides a 15-25 foot average buffer area between the Harmony Cottages project and Woodridge Subdivision to the south.

Although a neighborhood meeting was not required, a neighborhood Open House was held December 3rd to give existing neighborhood residents an opportunity to see the proposed plan and provide comment. The comments and questions along with responses were recorded and submitted to the City.

The project as designed meets all the performance standards in the LMN District. The General Development Standards in Chapter 3 of the Land Use Code are also met with one exception. The Applicant is requesting a Modification to the 30-foot setback along Harmony Road. The request and justification is included in the submittal package.

City Plan Principles and Policies achieved by the project include the following:

- Community and neighborhood livability policies having to do with compact urban development, safe attractive neighborhoods, creating housing options for all household types and income levels, and creating an attractive community image.
- Safety and Wellness policies having to do with providing opportunities to lead active and healthy lifestyles, and providing a safe place to live, learn and play.
- Transportation policies having to do with providing access to alternative modes of transportation.

HARMONY COTTAGES

DATE: 12/9/2015
 FILE NAME: 20151072SUB
 SCALE: 1"=30'
 DRAWN BY: CSK
 CHECKED BY: RE

KING SURVEYORS
 650 E. Garden Drive | Windsor, Colorado 80550
 phone: (970) 686-5011 | email: info@Kingsurveyors.com

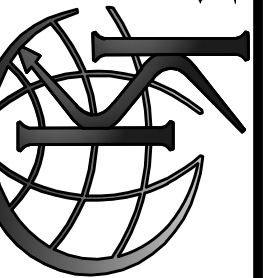

REVISIONS:	DATE:
REVISED PER CITY COMMENTS	CSK 1/18/16

HARMONY COTTAGES
 FOR
HARMONY LIMITED, LLC
 P.O. BOX 271519
 FORT COLLINS, CO 80527

PROJECT #:
20151072

2
 SHEET 2 OF 2

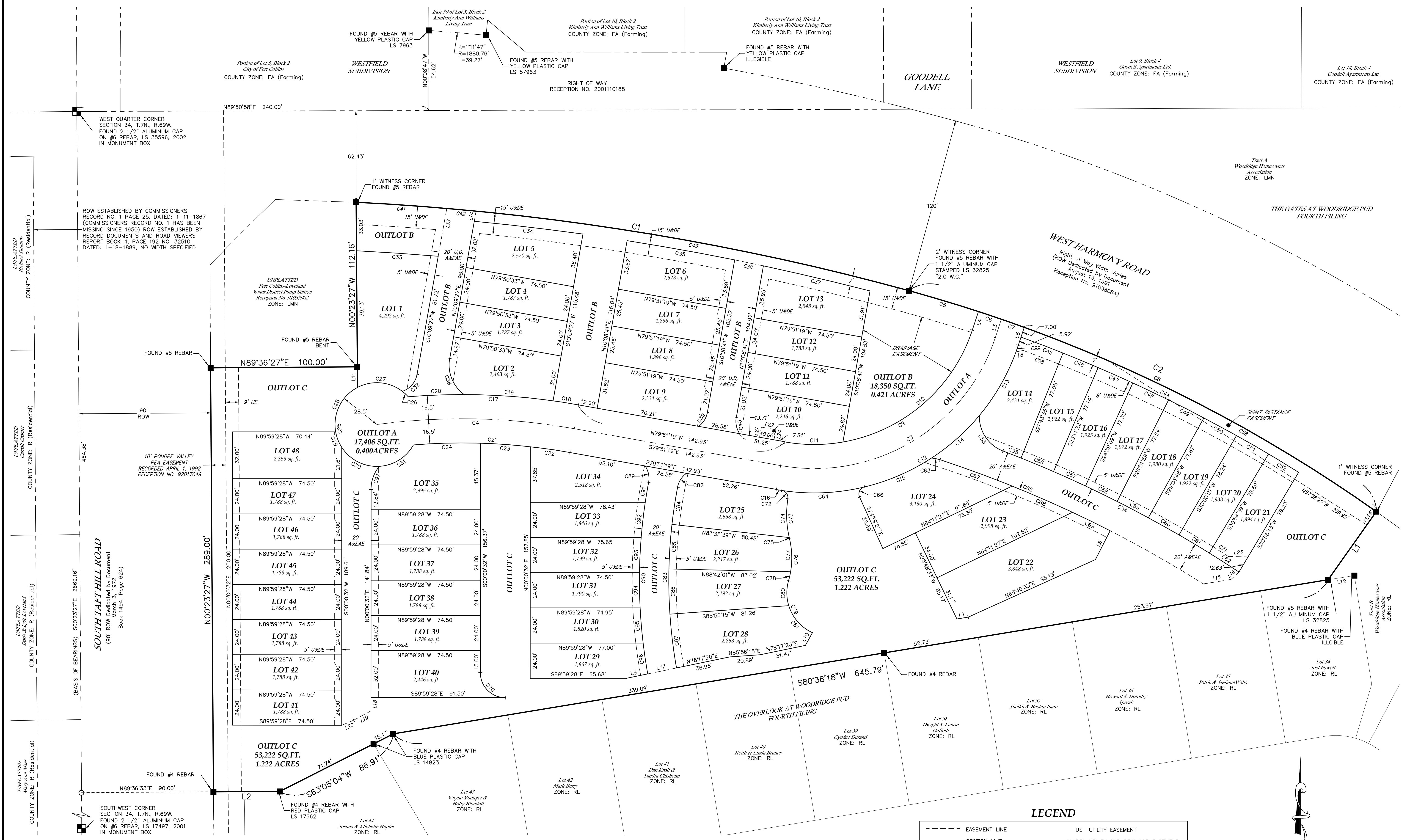

*** SEE SHEET 1 OF 2 FOR CURVE AND LINE TABLES**

PRELIMINARY

Ronnie L. Edwards - On Behalf Of King Surveyors
 Colorado Licensed Professional
 Land Surveyor #38480

LEGEND

---	EASEMENT LINE	UE	UTILITY EASEMENT
---	SECTION LINE	U&DE	UTILITY AND DRAINAGE EASEMENT
---	RIGHT-OF-WAY LINE	A&EAE	ACCESS AND EMERGENCY ACCESS EASEMENT
---	PROPERTY LINE	U,D,A&EAE	UTILITY, DRAINAGE, ACCESS AND EMERGENCY ACCESS EASEMENT
■	FOUND ALIQUOT CORNER AS DESCRIBED	LMN	LOW DENSITY MIXED-USE NEIGHBORHOOD DISTRICT
■	FOUND MONUMENT AS DESCRIBED	RL	LOW DENSITY RESIDENTIAL DISTRICT
●	SET 24" OF #4 REBAR WITH A YELLOW PLASTIC CAP STAMPED KS, LS 38480		
○	CALCULATED POSITION		

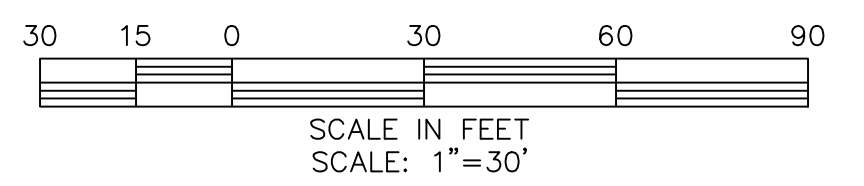

0:20151072.DRAWING(20151072SUB).dwg, 1/19/2016 4:06:57 PM

NOTES

1. PLAYGROUND SIZE AND LAYOUT WILL ADJUST TO ACCOMMODATE THE FULL ZONES OF THE CHOSEN PLAY EQUIPMENT.
2. PARALLEL PARKING SHALL BE ON THE NORTH SIDE OF THE PRIVATE DRIVE. NO PARKING SHALL BE ALLOWED ON THE SOUTH SIDE.
3. EACH DUPLEX UNIT HAS ONE OFF-STREET PARKING SPACE AND ONE GARAGE PARKING SPACE.

LEGEND

- N25°00'00"W 70.00' = PROPERTY BOUNDARY
- = DRAINAGE OR UTILITY EASEMENT
- - - - - = BUILDING SETBACK
- - - - - = EXISTING FENCE
- - - - - = PROPOSED 30" TALL PICKET FENCE
- - - - - = PROPOSED 6' TALL PRIVACY FENCE
- - - - - = FIBER OPTIC UTILITY
- - - - - = GAS UTILITY
- - - - - = OVERHEAD ELECTRIC UTILITY
- - - - - = STORM DRAIN UTILITY
- - - - - = SANITARY SEWER SERVICE UTILITY
- - - - - = SANITARY SEWER UTILITY
- - - - - = TELEPHONE UTILITY
- - - - - = ELECTRIC UTILITY
- - - - - = WATER LINE UTILITY

- E.A.E. = EMERGENCY ACCESS EASEMENT
- U.D.E. = UTILITY AND DRAINAGE EASEMENT
- PA = PLANTING AREA
- B.O.C. = BACK OF CURB
- E.G. = ELECTRIC / GAS METERS
- ☐ = STREET LIGHT SEE PHOTOMETRIC PLAN SHEET 5 OF 6

TYPICAL DUPLEX LOT

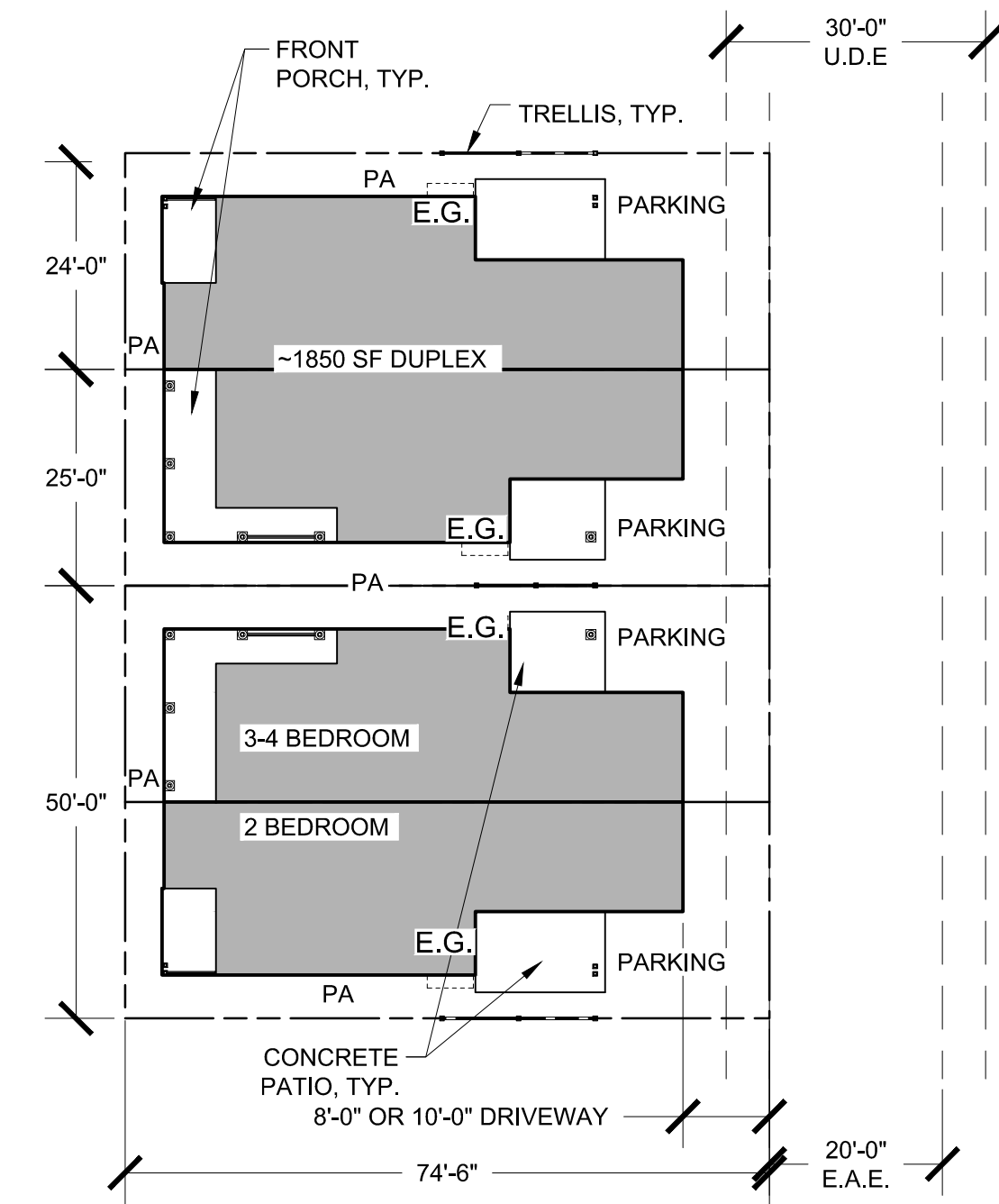

HARMONY COTTAGES

PROJECT DEVELOPMENT PLAN

FORT COLLINS, CO
PREPARED BY:



land planning ■ landscape architecture ■
urban design ■ entitlement ■

419 Canyon Ave. Suite 200 Fort Collins, CO 80521
phone 970.224.5828 | fax 970.225.6657 | www.ripleydesigninc.com

APPLICANT
RIPLEY DESIGN INC.
Russell Lee
419 Canyon Ave. Suite 200
Fort Collins, CO 80521
p. 970.224.5828
f. 970.225.6657

DEVELOPER
HARMONY LIMITED, LLC.
Rod Arndt
PO Box 271519
Fort Collins, CO 80527
p. 970.232.3605

ARCHITECT
GREG FISHER ARCHITECT, PLLC
Greg Fisher
3115 Clyde Street
Fort Collins, Colorado, 80524
p. 970.484.8433

ENGINEER
INTERWEST CONSULTING GROUP
Bob Almiral
1218 Ash Street #C
Windsor, CO 80550
p. 970.460.8487

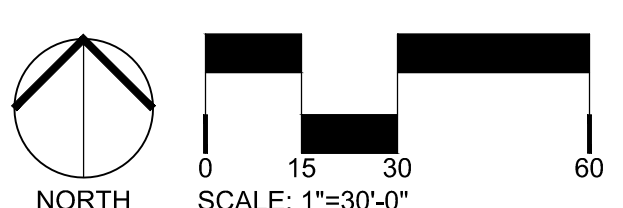

ORIGINAL SIZE 24X36

ISSUE	No.	DESCRIPTION	DATE
	01	PDP	12/18/15
	02	PDP REVISION	01/20/16
	03	PDP REVISION	03/21/16

REVISIONS	No.	DESCRIPTION	DATE

SITE PLAN

SEAL:

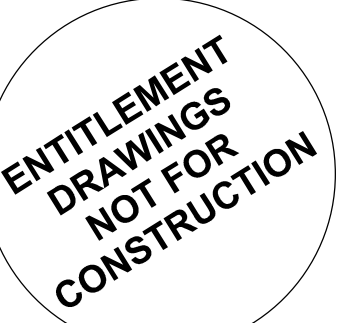

PROJECT No.: R15-067
DRAWN BY: SC
REVIEWED BY: RL

DRAWING NUMBER:

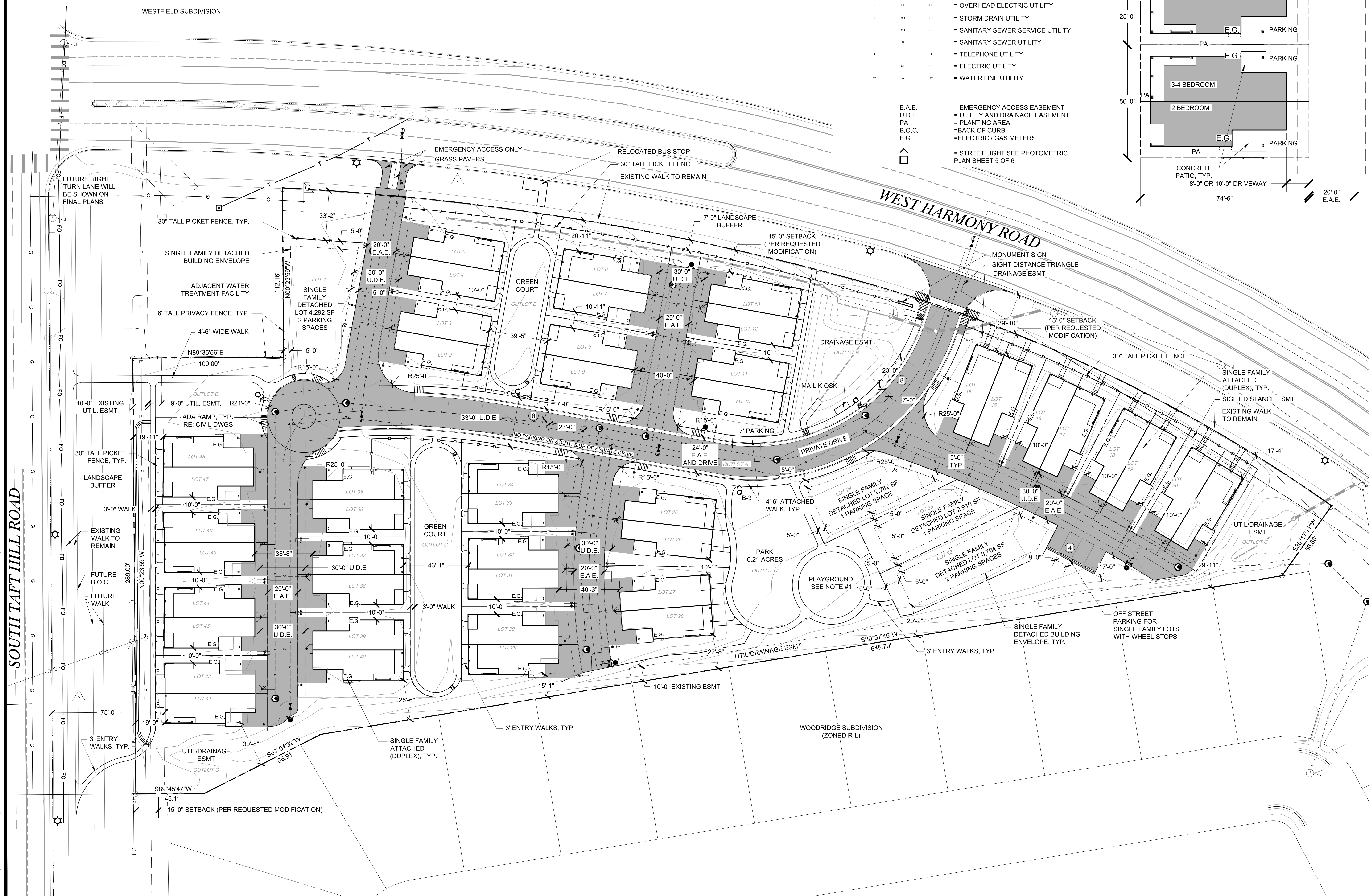

Plotted By: Sam Coutts Layout: 2 OF 6 SITE PLAN Printed On: 3/21/2016 2:23 PM File Name: Site Plan.dwg

A PERMIT MUST BE OBTAINED FROM THE CITY FORESTER BEFORE ANY TREES OR SHRUBS AS NOTED ON THIS PLAN ARE PLANTED, PRUNED OR REMOVED IN THE PUBLIC RIGHT-OF-WAY. THIS INCLUDES ZONES BETWEEN THE SIDEWALK AND CURB, MEDIANS AND OTHER CITY PROPERTY. THIS PERMIT SHALL APPROVE THE LOCATION AND SPECIES TO BE PLANTED. FAILURE TO OBTAIN THIS PERMIT IS A VIOLATION OF THE CITY OF FORT COLLINS CODE SUBJECT TO CITATION (SECTION 27-31) AND MAY ALSO RESULT IN REPLACING OR RELOCATING TREES AND A HOLD ON CERTIFICATE OF OCCUPANCY.

MATERIAL LEGEND

SYMBOL	DESCRIPTION	QTY
[Hatched Pattern]	SHRUB AND PERENIAL PLANTING AREA (MODERATE HYDROZONE)	19,910 SF
[Dotted Pattern]	HOA IRRIGATED TURF (HIGH HYDROZONE)	59,655 SF
[Cross-hatched Pattern]	DRYLAND SEED (LOW HYDROZONE)	3,387 SF
[Grid Pattern]	PLAY SURFACING	1,521 SF
[Stippled Pattern]	ROCK MULCH (MODERATE HYDROZONE)	560 SF
[Dotted Pattern]	RIPARIAN SEED (LOW HYDROZONE)	2,205 SF

*RIPARIAN SEED AND PLANTINGS TO COMPLY WITH THE CITY OF FORT COLLINS LANDSCAPE DESIGN STANDARDS AND GUIDELINES FOR STORM WATER DETENTION FACILITIES

TREES	COMMON NAME
CS	NORTHERN CATALPA
GI	THORNLESS COMMON HONEYLOCUST
JB	BLUE POINT JUNIPER
JG	GRAY GLEAM JUNIPER
JS	SKYROCKET JUNIFER
MS	SPRING SNOW CRAB APPLE
PF	COLORADO SPRUCE
PIN	AUSTRIAN BLACK PINE
PIS	SOUTHWESTERN WHITE PINE
PA2	AUTUMN BLAZE PEAR
PC2	CHANTICLEER PEAR
QM	BURR OAK
QP	ENGLISH OAK
TG	GREENSPIRE LITTLELEAF LINDEN
ULA	ACCOLADE ELM

SHRUBS	COMMON NAME
AB	BAILEY COMPACT AMUR MAPLE
AAR	REGENT SERVICEBERRY
AA	SASKATOON SERVICEBERRY
BTN	DWARF REDLEAF JAPANESE BARBERRY
BTA	REDLEAF JAPANESE BARBERRY
BA	NANHO WHITE BUTTERFLY BUSH
PON	DWARF NINEBARK
PC	DWARF ALBERTA SPRUCE
PG	DWARF GLOBE GREEN SPRUCE
RD	DON JUAN CLIMBING ROSE
SM2	DAKOTA GOLDCHEER SPIREA
SVR	RENAISSANCE VANHOUTE SPIREA
SGO	GOLDMOUND SPIREA
SM	MISS KIM LILAC

ORNAMENTAL GRASS	COMMON NAME
BGB	BLONDE AMBITION GRAMA GRASS
CAK	FEATHER REED GRASS
PV	SWITCH GRASS

PERENNIAL	COMMON NAME
AC	HYBRID YARROW
AC2	ANISE HYSSOP
AF	FRINGED WORMWOOD
HO	STELLA DE ORO DAYLILY
HR	HYBRID CORAL BELLS
RFO	BLACK-EYED SUSAN
SA2	AUTUMN JOY SEDUM

*SEE SHEET 4 OF 6 FOR COMPLETE PLANT SCHEDULE

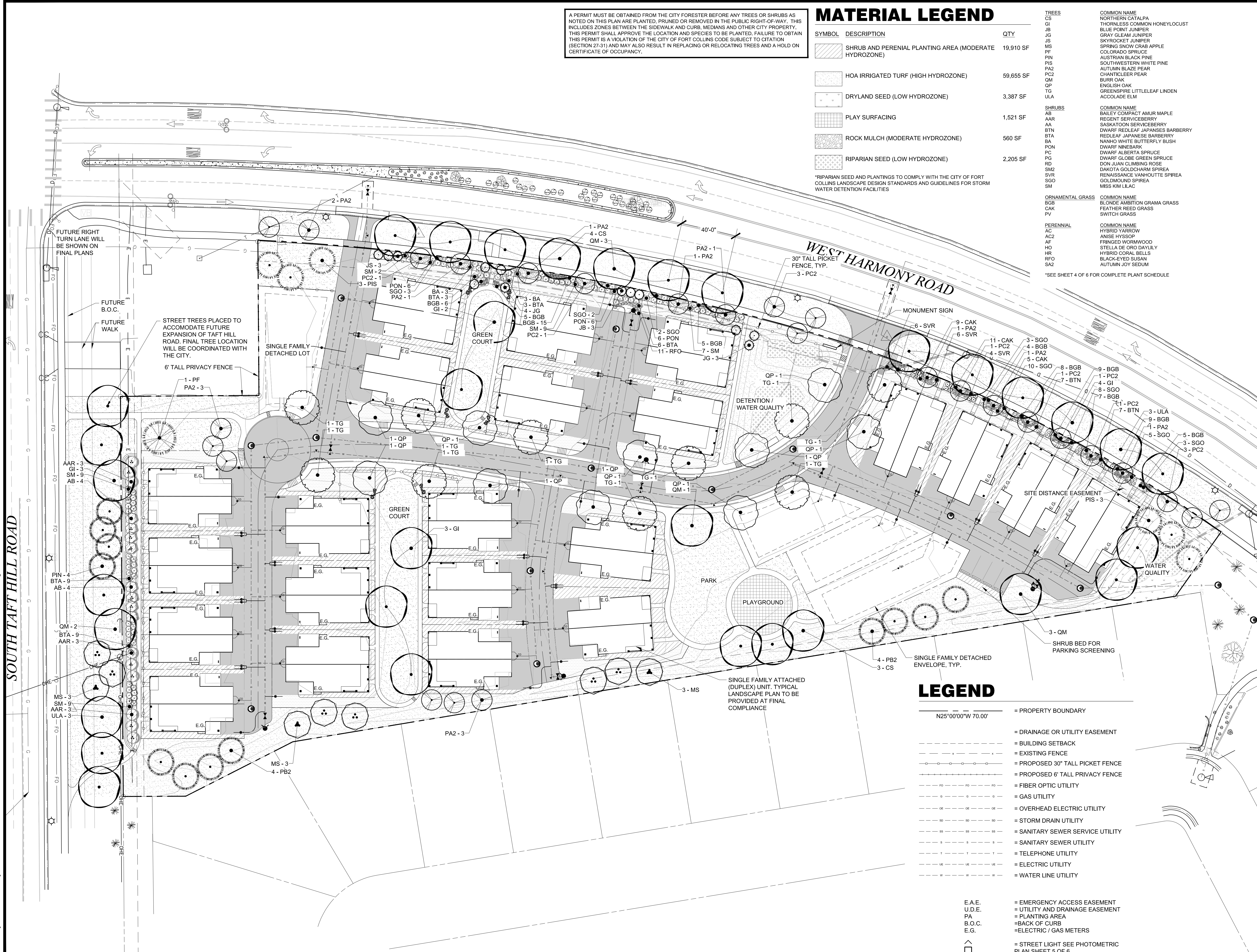

LEGEND

- - - - - = PROPERTY BOUNDARY
- - - - - = DRAINAGE OR UTILITY EASEMENT
- - - - - = BUILDING SETBACK
- - - - - = EXISTING FENCE
- - - - - = PROPOSED 30" TALL PICKET FENCE
- - - - - = PROPOSED 6" TALL PRIVACY FENCE
- - - - - = FIBER OPTIC UTILITY
- - - - - = GAS UTILITY
- - - - - = OVERHEAD ELECTRIC UTILITY
- - - - - = STORM DRAIN UTILITY
- - - - - = SANITARY SEWER SERVICE UTILITY
- - - - - = SANITARY SEWER UTILITY
- - - - - = TELEPHONE UTILITY
- - - - - = ELECTRIC UTILITY
- - - - - = WATER LINE UTILITY

- E.A.E. = EMERGENCY ACCESS EASEMENT
- U.D.E. = UTILITY AND DRAINAGE EASEMENT
- PA = PLANTING AREA
- B.O.C. = BACK OF CURB
- E.G. = ELECTRIC / GAS METERS
- ^ = STREET LIGHT SEE PHOTOMETRIC PLAN SHEET 5 OF 6

HARMONY COTTAGES

PROJECT DEVELOPMENT PLAN

FORT COLLINS, CO
PREPARED BY:



land planning landscape architecture urban design entitlement

419 Canyon Ave. Suite 200 Fort Collins, CO 80521
phone 970.224.5828 | fax 970.225.6657 | www.ripleydesigninc.com

APPLICANT
RIPLEY DESIGN INC.
Russell Lee
419 Canyon Ave. Suite 200
Fort Collins, CO 80521
p. 970.224.5828
f. 970.225.6657

DEVELOPER
HARMONY LIMITED, LLC.
Rod Arndt
PO Box 271519
Fort Collins, CO 80527
p. 970.232.3605

ARCHITECT
GREG FISHER ARCHITECT, PLLC
Greg Fisher
3115 Clyde Street
Fort Collins, Colorado, 80524
p. 970.484.8433

ENGINEER
INTERWEST CONSULTING GROUP
Bob Almiral
1218 Ash Street #C
Windsor, CO 80550
p. 970.460.8487

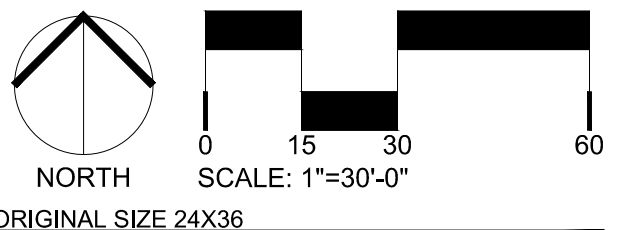

ORIGINAL SIZE 24X36

ISSUED	No.	DESCRIPTION	DATE
	01	PDP	12/16/15
	02	PDP REVISION	01/20/16
	03	PDP REVISION	03/01/16

REVISIONS	No.	DESCRIPTION	DATE

LANDSCAPE PLAN

SEAL:



PROJECT No.:	R15-067
DRAWN BY:	SC
REVIEWED BY:	RL
DRAWING NUMBER:	

3 OF 6

Plotted By: Sam Coultis Layout: 3 OF 6 LANDSCAPE PLAN Printed On: 3/21/2016 2:23 PM File Name: LANDSCAPE NOTES.dwg



1 Front Elevation
3/16" = 1'-0"



2 Rear Elevation
3/16" = 1'-0"



3 Left Side Elevation
3/16" = 1'-0"



4 Right Side Elevation
3/16" = 1'-0"

MATERIALS LEGEND

- W-BB BOARD & BATTEN SIDING IN VARYING COLORS
- W-LS LAP SIDING IN VARYING COLORS
- R-CS COMPOSITION SHINGLES IN GRAY COLOR

KEYNOTES

- 1 FASCIA & TRIM IN WHITE COLOR
- 2 TRADITIONAL STYLE WINDOWS IN WHITE COLOR
- 3 TRADITIONAL COLUMNS OF VARYING STYLE IN WHITE COLOR
- 4 TRADITIONAL RAILINGS OF VARYING STYLE IN WHITE COLOR
- 5 TRADITIONAL PICKET FENCES OF VARYING STYLE IN WHITE COLOR
- 6 POTENTIAL SOLAR PHOTO-VOLTAIC SYSTEM ARRAYS - TYPICAL



land planning ■ landscape architecture ■ urban design ■ entitlement

Habitat for Humanity Harmony Cottages Modification Request

DIVISION 3.5.2(E)(1) RESIDENTIAL SETBACKS

Setback from Arterial Streets. The minimum setback of every residential building and of every detached accessory building that is incidental to the residential building shall be thirty (30) feet from any arterial street right-of-way, except for those buildings regulated by [Section 3.8.30](#) of this Code, which buildings must comply with the setback regulations set forth in [Section 3.8.30](#).

Reason for Request

Habitat for Humanity is seeking to fill a need for affordable housing in Fort Collins. As stated later in this document, Habitat seeks to build single family attached and detached houses for people whose income is between 35% and 60% of the Fort Collins average median income (AMI).

With the dramatic increase in home and land prices in Fort Collins, it is crucial the City has attainable housing for its citizens who fall in the modest income category. For a community to be healthy, housing needs to be available for the certified nursing assistant, the local barista, the single parent and a myriad of other professionals who are crucial to our economy but can not afford to enter the costly and competitive Fort Collins housing market. In order to bring the price of these needed homes to a level these citizens can afford, the density of Harmony Cottages needs to be at a certain level to cover the cost of development infrastructure. In order to get to that density, there are a few of the single family attached units that will be closer than the 30' right of way off set required in section 3.5.2(E)(1). In addition, if these units were a multifamily product (3-plex or greater) the current separation from the right of way would meet code.

Below we have laid out our justifications for the modification. Our arguments center around an enhanced landscape buffer to mitigate the proximity to Harmony and Taft Hill roads and the ability of the project to fulfill the need for affordable housing as stated in City Plan and the City's Affordable Housing Strategic Plan.

Thinking outside of the box for over two decades.

401 W. Mountain Ave., Suite 100 ■ Fort Collins, CO 80521 ■ tel. 970.224.5828 ■ fax 970.224.1662 ■
www.ripleydesigninc.com

Justifications

The Land Use Code states that the decision-maker may grant a modification of standards only if it finds that the granting of the modification would not be detrimental to the public good; and the decision-maker must also find that the Modification meets one of the following four criteria described in the LUC.

(1) the plan as submitted will promote the general purpose of the standard for which the modification is requested equally well or better than would a plan which complies with the standard for which a modification is requested;

The standard set forth in section 3.5.2(E)(1) is to provide an adequate buffer from arterials and single family dwellings. Below are two plan elements incorporated into the Harmony Cottages design that will meet or exceed the intent of the standard set forth in this section.

In order to mitigate the proximity of the single family attached houses to the Harmony and Taft Hill road ways, we are proposing to more than double the amount of landscape required along the street scape. The code would require 17 trees along Harmony Road and 8 trees along Taft Hill. In order to provide a visual buffer from the houses and the roads, we are proposing to provide 44 trees along Harmony and 16 along Taft Hill. That would more than double the required landscape.

The existing right-of-ways along Harmony and Taft Hill are also larger than the City standard providing a greater distance from the homes and the road than would be typical in the City. The typical park way along a 4 lane arterial is 16' (the area between the back walk and the road). The park way along Harmony is 24' and the park way along Taft Hill it is 55'.

With a 30' set back along an arterial and a typical 16' parkway, the code would require single family homes to be set back 46' from the arterial road. Our current design is very close to meeting or exceeding that dimension. The homes along Harmony will be setback from the road between 39' and 44'. That is only 2'-7' closer than the current standards would require. The homes along Taft Hill are set back 72' from the road way exceeding the required 46' set back by 26'.

Lastly, if the units along Harmony and Taft Hill were a 3-plex unit rather than a duplex, the code would allow the homes to be 15' from the right of way matching the closest set back shown on the plans.

Therefore, due to the substantial increase in the streetscape landscape, the separation of the homes from the road ways and the fact that a 3-plex unit would comply with the Code, the applicant believes the proposed development promotes the standard set forth in section 3.5.2(E)(1) equal to or better than a plan that would comply with the code.

(2) the granting of a modification from the strict application of any standard would, without impairing the intent and purpose of this Land Use Code, substantially alleviate an existing, defined and described problem of city-wide concern or would result in a substantial benefit to the city by reason of the fact that the proposed project would substantially address an important community need specifically and expressly defined and described in the city's Comprehensive Plan or in an adopted policy, ordinance or resolution of the City Council, and the strict application of such a standard would render the project practically infeasible;

Development of the Harmony Cottages project would result in a substantial benefit to the City because the proposed community would address the need for affordable housing as expressed in City Plan. City Plan contains overarching policy statements that promote balanced and integrated living patterns. Topics addressed include the goal of a mix of housing types in all City sectors. Additionally, affordable housing is encouraged to be dispersed throughout the City.

The City also has an *Affordable Housing Strategic Plan*, which establishes priorities and strategies for the City's affordable housing programs and informs the Consolidated Plan and Annual Action Plans required by HUD. The most recent plan (2010) identifies four priorities to address affordable housing needs:

- Increase the inventory of affordable units;
- Preserve existing affordable housing units, and;
- Increase housing and facilities for people with special needs;

To meet the definition of Affordable Housing in the City of Fort Collins, 10% of units must be set-aside for households earning less than 80% of Area Median Income (AMI) adjusted for household size.

The Applicant is proposing to set aside 100% of the dwelling units for households earning less than 60% of AMI. In addition the properties will be deed income restricted for 20 years. The first homeowner will have to qualify earning between 35-60% AMI and then, if resold, the new buyer would need to earn less than 80% AMI.

Conclusion

Affordable housing will become an increasingly important issue within the City of Fort Collins as the property values continue to rise. By filling this City wide need and providing an enhanced landscape buffer between homes and the adjacent arterials, the applicant believes the proposed plans meet the modification requirements set forth in section 2.8.2 of the Land use Code.

**MEMORANDUM**

TO: Rod Arndt, Harmony Limited
Sara Coutts, The Neenan Company
Linda Ripley/Russ Lee, Ripley Design Inc.
Martina Wilkinson, City of Fort Collins

FROM: Matt Delich

DATE: November 25, 2015

SUBJECT: Harmony Cottages Transportation Impact Study
(File: 1587ME01)



This memorandum constitutes a transportation impact study for Harmony Cottages. The Harmony Cottages site is located in the southeast quadrant of the Taft Hill/Harmony-Larimer County Road 38E (LCR38E) intersection, and is shown in Figure 1. The current site plan for Harmony Cottages is shown in Figure 2. Harmony Cottages is proposed as 48 single family dwelling units (44 duplexes and 4 detached houses). Primary access to the Harmony Cottages site will be via a full-movement access to/from Harmony Road, approximately 640 feet east of Taft Hill Road. The scope of this memorandum was discussed with Martina Wilkinson, City of Fort Collins Traffic Operations. Since the trip generation is expected to be low, a memorandum analyzing impacts to the Taft Hill/Harmony-LCR38E intersection was requested. A base assumptions form and related information is provided in Appendix A.

Harmony Road is to the north of (adjacent to) the proposed Harmony Cottages site. It is an east-west street classified as a four-lane arterial east of Taft Hill Road, and LCR38E is classified as a two-lane arterial west of Taft Hill Road according to the Fort Collins Master Street plan. Currently, Harmony Road has a four-lane cross section with center median lane adjacent to the Harmony Cottages site. At the Taft Hill/Harmony-LCR38E intersection, Harmony Road has eastbound and westbound left-turn lanes, a through lane in each direction, and a westbound right-turn lane. The Taft Hill/Harmony-LCR38E intersection has signal control. The posted speed limit in this area of Harmony Road is 40 mph.

Taft Hill Road is to the west of (adjacent to) the proposed Harmony Cottages site. It is a north-south street classified as a four-lane arterial according to the Fort Collins Master Street Plan. Currently, Taft Hill Road has a two-lane cross section with center median lane adjacent to the Harmony Cottages site. At the Taft Hill/Harmony-LCR38E intersection, Taft Hill Road has a northbound left-turn lane, dual southbound left-turn lanes, one through lane in each direction, and a southbound right-turn lane. The posted speed limit in this area of Taft Hill Road is 40 mph.

The existing geometry at the Taft Hill/Harmony-LCR38E intersection is shown in Figure 3. Recent peak hour traffic counts at the Taft Hill/Harmony-LCR38E intersection are shown in Figure 4. Traffic counts at the Taft Hill/Harmony-LCR38E intersection were obtained in June 2014 by the City of Fort Collins. Raw traffic count data is provided in Appendix B. Using the volumes shown in Figure 4, the current peak hour operation at the Taft Hill/Harmony-LCR38E intersection is shown in Table 1. Calculation forms for these analyses are provided in Appendix C. The Taft Hill/Harmony-LCR38E intersection was analyzed using the signalized intersection techniques from the 2010 Highway Capacity Manual (2010 HCM). A description of level of service for signalized and unsignalized intersections from the 2010 Highway Capacity Manual is provided in Appendix C. Table 4-3 (revised per staff comments regarding type of intersection) showing the Fort Collins Motor Vehicle LOS Standards (Intersections) are also provided in Appendix C. This site is in an area termed “low density mixed-use” on the Fort Collins Structure Plan. In areas termed “low density mixed-use,” acceptable overall operation at signalized intersections during the peak hours is defined as level of service D or better. At signalized intersections, acceptable operation of any leg and any movement is level of service D. At arterial/arterial and arterial/collector or local stop sign controlled intersections, acceptable operation is considered to be at level of service F for any approach leg. At collector/local stop sign controlled intersections, acceptable operation is considered to be at level of service C for any approach leg. As can be seen in Table 1, the Taft Hill/Harmony intersection is currently operating acceptably with existing control and geometry. It is important to note that a northbound right-turn lane and an eastbound right-turn lane are required using the existing traffic volumes at the Taft Hill/Harmony-LCR38E intersection.

Trip Generation, 9th Edition, ITE was used to estimate the daily and peak hour trip generation for Harmony Cottages. From this reference, the equations for Single Family Detached (Code 210) were used to estimate the daily and peak hour trip generation as shown in Table 2. The trip generation resulted in 534 daily trip ends, 43 morning peak hour trip ends, and 54 afternoon peak hour trip ends. The trip distribution for Harmony Cottages is shown in Figure 5. Figure 6 shows the site generated peak hour traffic.

Background traffic projections for the short range (2020) future horizon were obtained by factoring the current traffic volumes by two percent per year. Figure 7 shows the short range (2020) background peak hour traffic at the Taft Hill/Harmony-LCR38E intersection. The traffic volumes generated by the proposed Harmony Cottages were added to the background traffic volumes to produce the total traffic volume forecasts for the short range (2020) future. Figure 8 shows the short range (2020) total peak hour traffic at the key intersections.

Figure 9 shows a schematic of the short range (2020) geometry. As mentioned earlier, a northbound right-turn lane and an eastbound right-turn lane are required using the existing traffic volumes at the Taft Hill/Harmony-LCR38E intersection. However, only the northbound right-turn lane is shown on Figure 9, since it is the only warranted auxiliary lane required to achieve acceptable operation at the Taft Hill/Harmony-

LCR38E intersection. The project will not have eastbound right-turning traffic at this intersection. The eastbound right-turn lane is not necessary to achieve acceptable operation at this intersection. The median area on Harmony Road, east of the Site Access, should be re-stripped with a westbound left-turn lane. That left-turn lane should provide 50 feet of storage and 435 feet of deceleration (including 200 feet of bay taper). According to LCUASS, Figure 8-4, an eastbound right-turn lane is not required on Harmony Road approaching the Site Access.

Table 3 shows the short range (2020) background morning and afternoon peak hour operation at the Taft Hill/Harmony-LCR38E intersection. The Taft Hill/Harmony-LCR38E intersection will operate at acceptable levels of service, except for the northbound leg during the afternoon peak hour. With the warranted northbound right-turn lane and an adjustment in the signal timing, all movements at the Taft Hill/Harmony-LCR38E intersection will operate acceptably. Calculation forms for these analyses are provided in Appendix D. The analyses were not run with an eastbound right-turn lane, since this lane was not necessary to achieve acceptable operation.

Table 4 shows the short range (2020) total morning and afternoon peak hour operation at the Taft Hill/Harmony-LCR38E and Harmony/Site Access intersections. As with the background operation, the Taft Hill/Harmony-LCR38E intersection will operate at acceptable levels of service, except for the northbound leg during the afternoon peak hour. With the warranted northbound right-turn lane and an adjustment in the signal timing, all movements at the Taft Hill/Harmony-LCR38E intersection will operate acceptably. The Harmony/Site Access intersection will operate at acceptable levels of service. Calculation forms for these analyses are provided in Appendix E. The analyses were not run with an eastbound right-turn lane, since this lane was not necessary to achieve acceptable operation.

The Harmony Cottages site is in an area within which the City requires pedestrian and bicycle level of service evaluations. Appendix F shows a map of the area that is within 1320 feet of the Harmony Cottages site. The Harmony Cottages site is located within an area termed as “all other areas,” which sets the pedestrian level of service threshold at LOS C for all measured categories. There are four destination areas within 1320 feet of the proposed Harmony Cottages: 1) the commercial area to the northwest, 2) the residential neighborhood to the north of Harmony Road, 3) the residential neighborhood to the south and southeast, and 4) the residential neighborhood to the southwest. Appendix F contains a Pedestrian LOS Worksheet. Destination areas 1, 2, and 4 are not in the City of Fort Collins. Sidewalks either do not exist or are sporadic in these areas. The continuity measure would be achieved when sidewalks are built in these areas.

Based upon Fort Collins bicycle LOS criteria, there are no destination areas within 1320 feet of the Harmony Cottages site.

Currently, this area is served by Transfort Route 12 along Harmony Road and Taft Hill Road. The transit service is acceptable.

It is concluded that the Taft Hill/Harmony-LCR38E and Harmony/Site Access intersections will operate acceptably with recommended geometry and control. The Taft Hill/Harmony-LCR38E intersection will meet the Fort Collins criteria of level of service D or better during the peak hours with regard to operation with an adjustment in the signal timing. No further transportation analyses are required at this time.

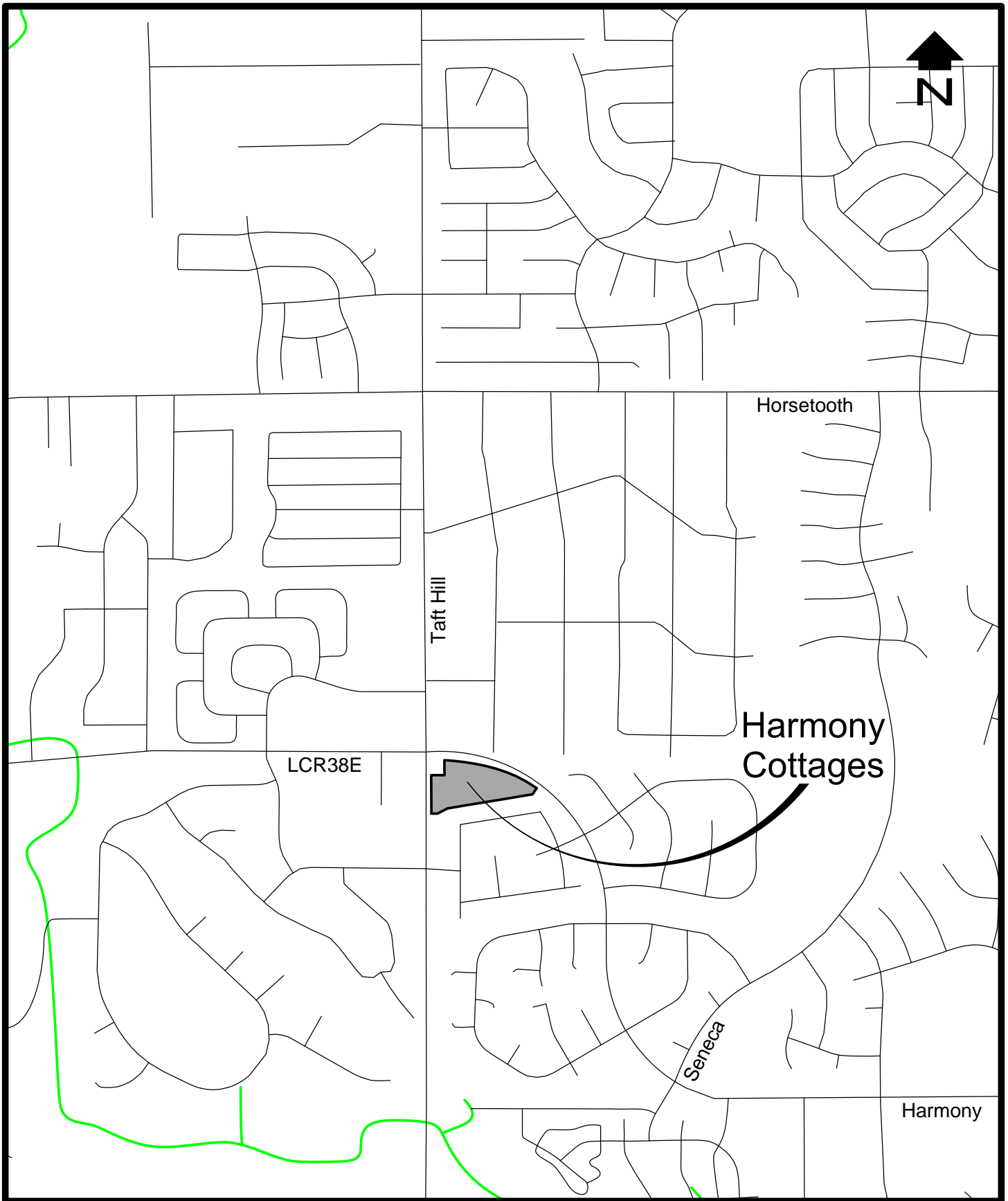

SCALE: 1"=1000'

SITE LOCATION

Figure 1



SCALE: 1"=100'

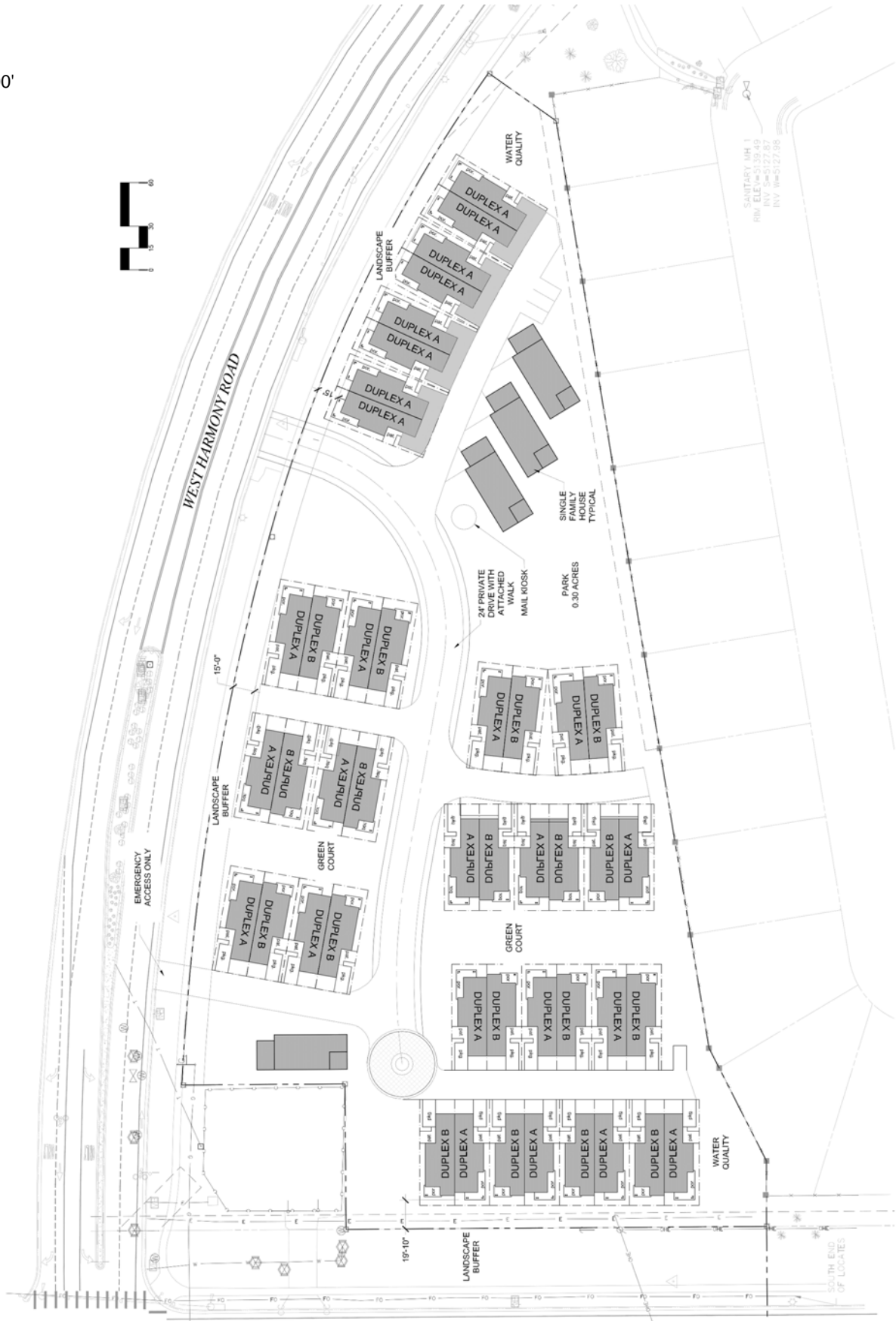

SITE PLAN

Figure 2

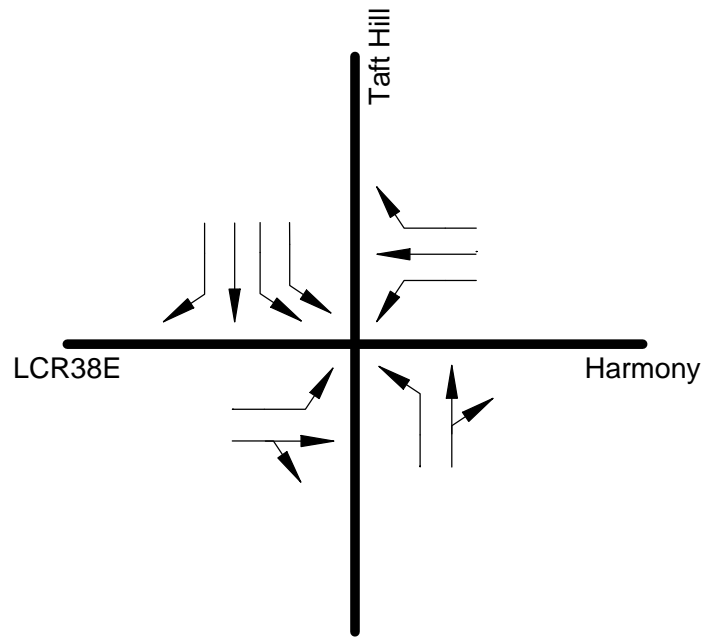

← - Denotes Lane

EXISTING INTERSECTION GEOMETRY

Figure 3

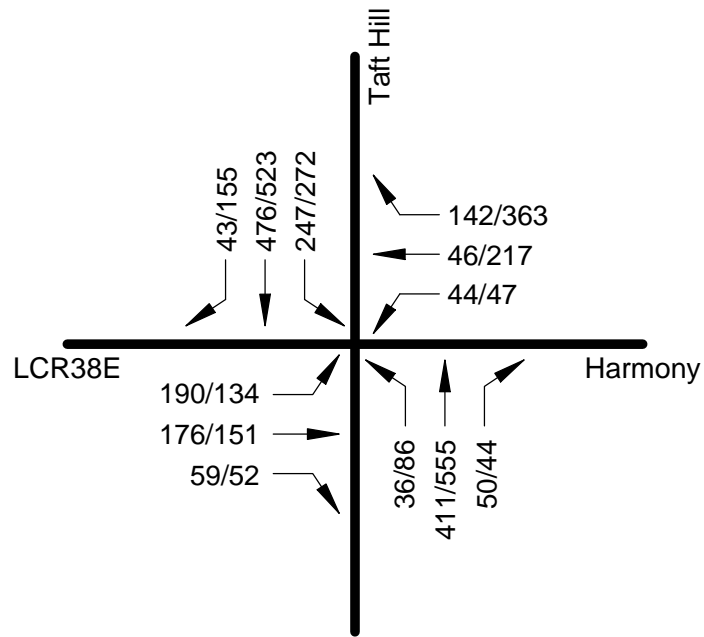

← AM/PM

RECENT PEAK HOUR TRAFFIC

Figure 4

TABLE 1
Current Peak Hour Operation

Intersection	Movement	Level of Service	
		AM	PM
Taft Hill/Harmony-LCR38E (signal)	EB LT	C	C
	EB T/RT	D	D
	EB APPROACH	D	C
	WB LT	C	C
	WB T	D	D
	WB RT	A	D
	WB APPROACH	D	D
	NB LT	D	D
	NB T/RT	C	D
	NB APPROACH	C	D
	SB LT	C	D
	SB T	B	B
	SB RT	A	B
	SB APPROACH	C	C
	OVERALL	C	C

TABLE 2
Trip Generation for Harmony Cottages

Code	Use	Size	AWDTE		AM Peak Hour				PM Peak Hour			
			Rate	Trips	Rate	In	Rate	Out	Rate	In	Rate	Out
210	Single Family	48 D.U.	EQ	534	EQ	11	EQ	32	EQ	34	EQ	20

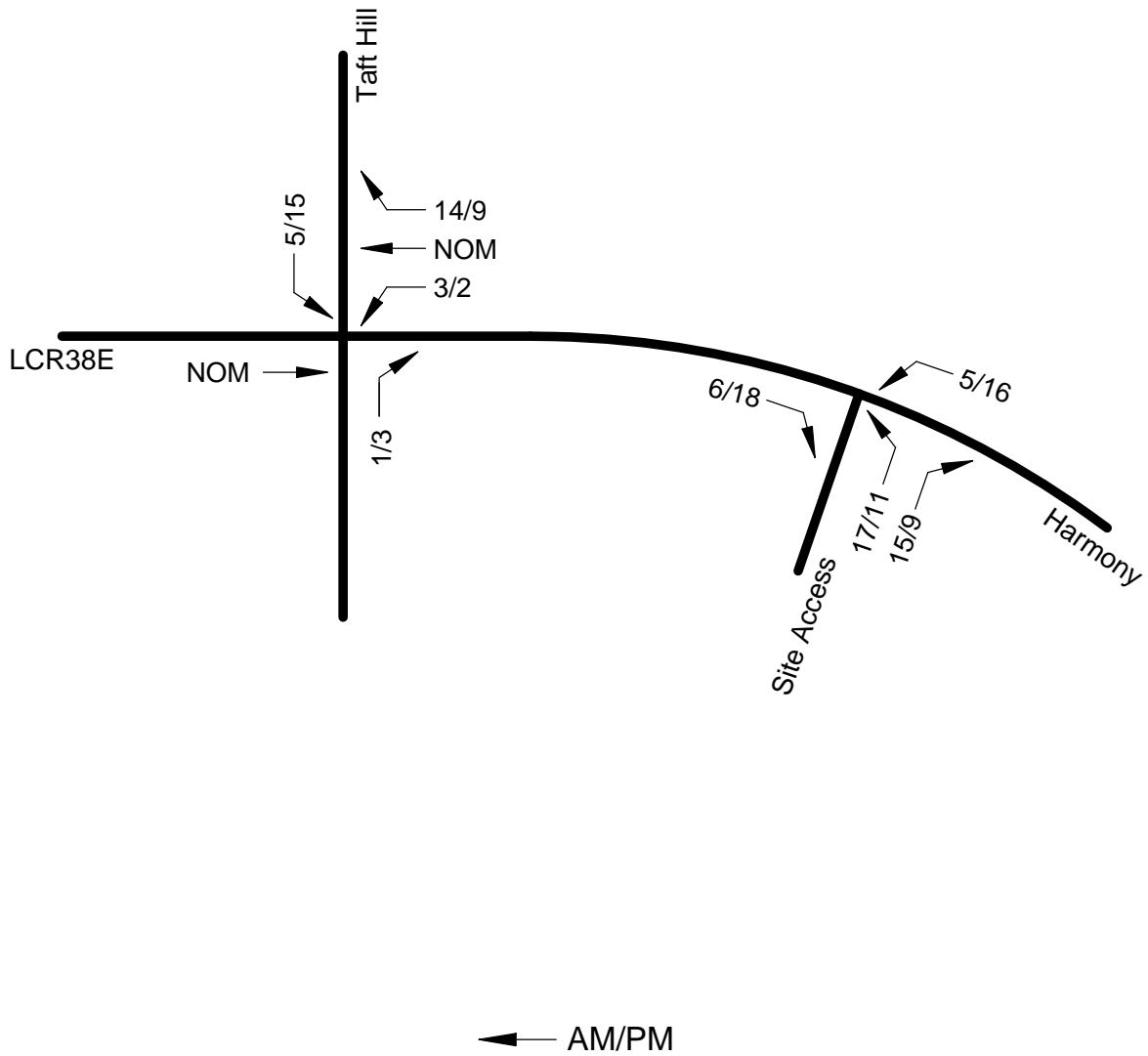

SITE GENERATED
PEAK HOUR TRAFFIC

Figure 5

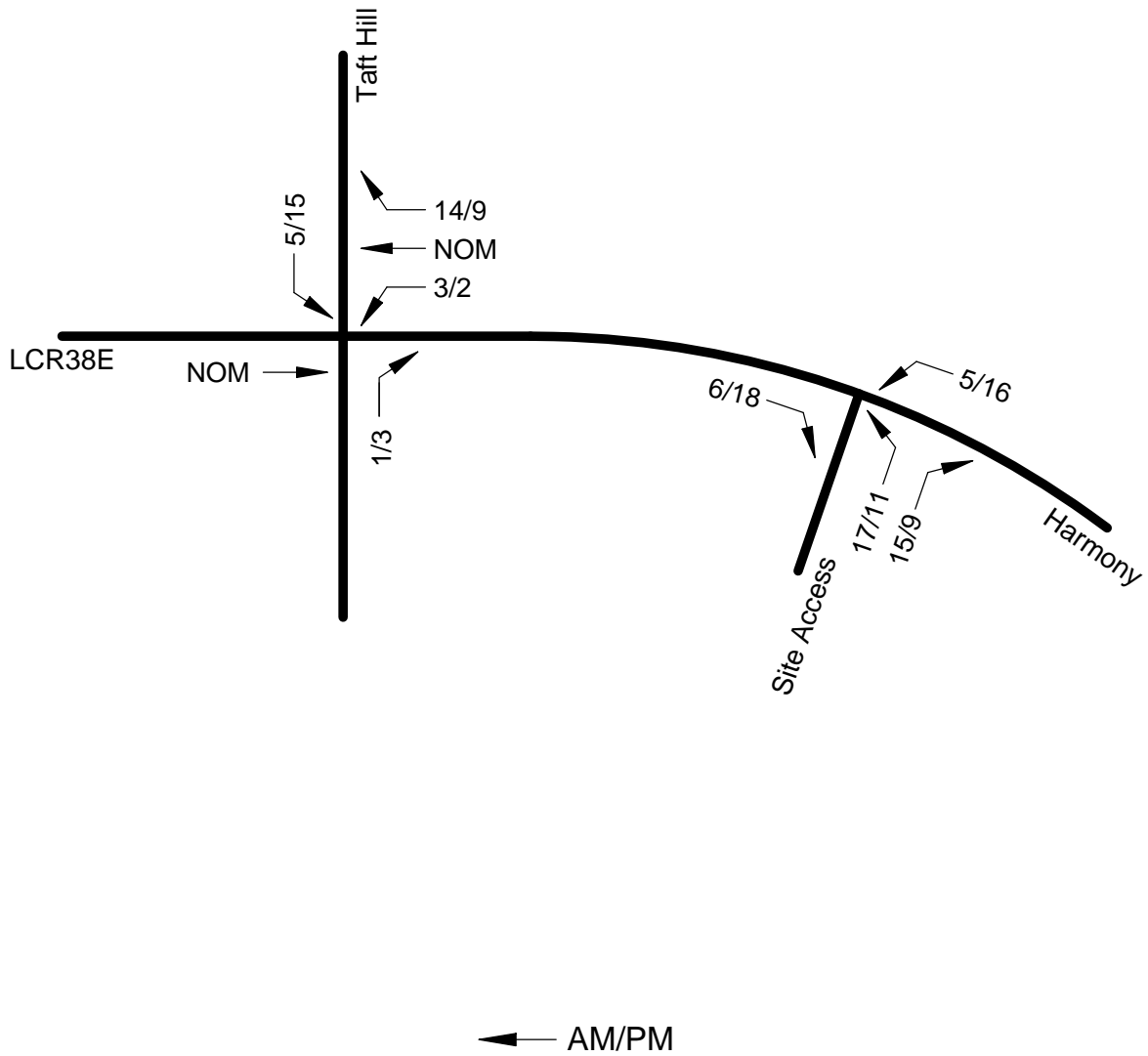

SITE GENERATED
PEAK HOUR TRAFFIC

Figure 6

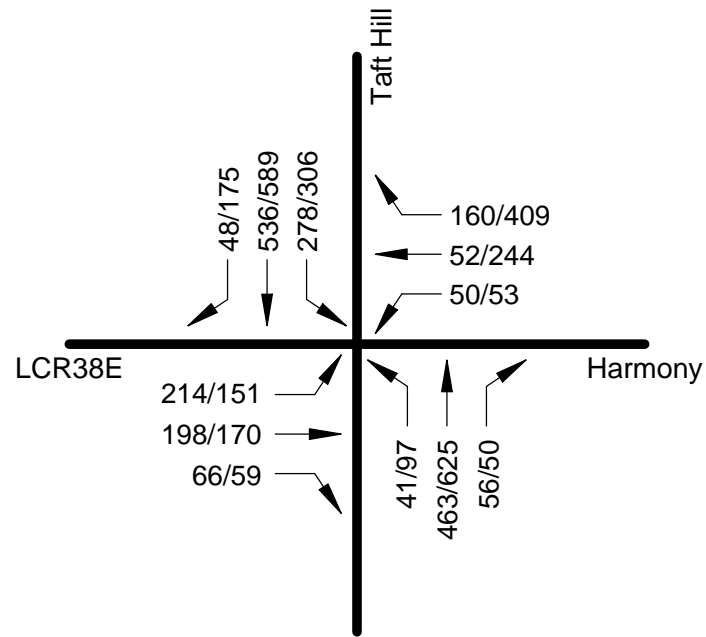

SHORT RANGE (2020) BACKGROUND PEAK HOUR TRAFFIC

Figure 7

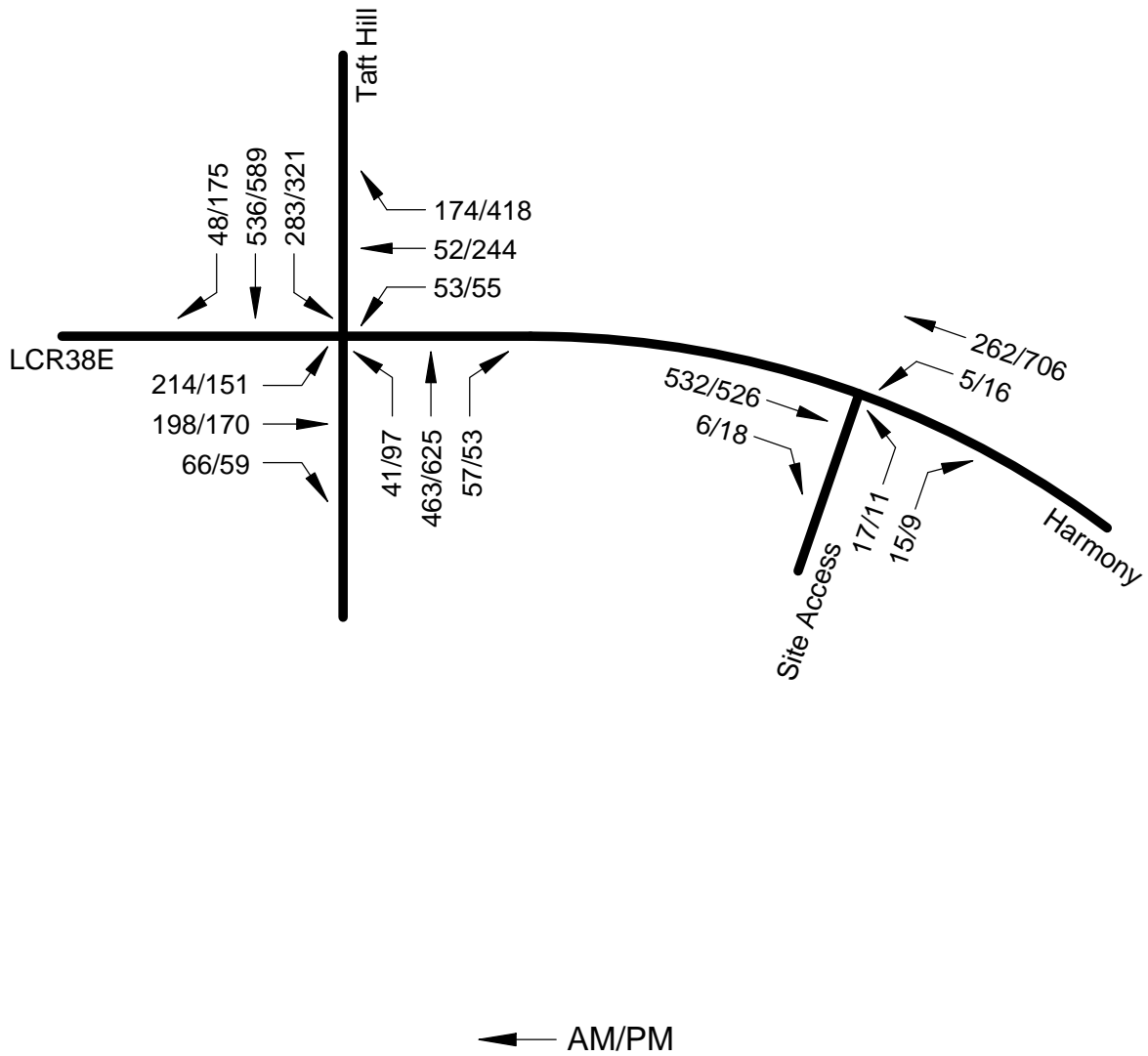

SHORT RANGE (2020) TOTAL PEAK HOUR TRAFFIC

Figure 8

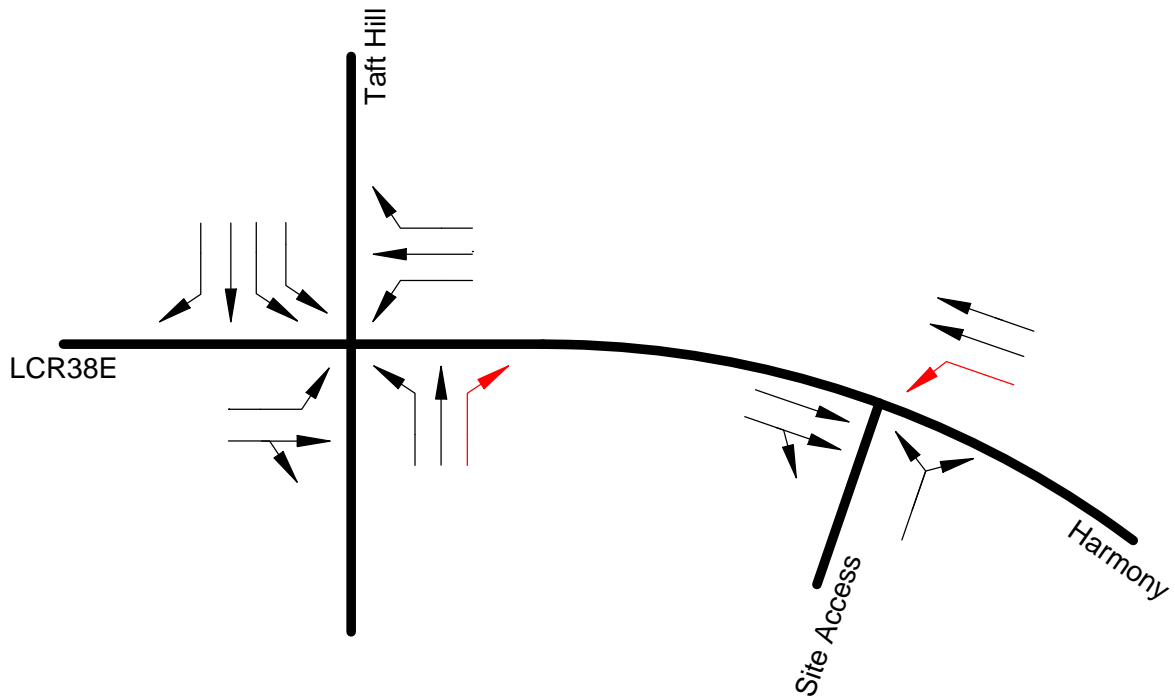

- ← - Existing Lane
- - Recommended New Lane

SHORT RANGE (2020) RECOMMENDED GEOMETRY

Figure 9

TABLE 3
Short Range (2020) Background Peak Hour Operation

Intersection	Movement	Level of Service	
		AM	PM
Taft Hill/Harmony-LCR38E (signal) (Existing Geometry and City Timing)	EB LT	C	C
	EB T/RT	D	D
	EB APPROACH	D	C
	WB LT	C	C
	WB T	D	D
	WB RT	A	D
	WB APPROACH	C	D
	NB LT	D	E (55.5 secs)
	NB T/RT	C	F (64.9 secs)
	NB APPROACH	C	E (63.7 secs)
	SB LT	D	D
	SB T	B	C
	SB RT	A	B
	SB APPROACH	C	C
	OVERALL	C	D
Taft Hill/Harmony-LCR38E (signal) (With NB RT-Lane and Adjusted Timing)	EB LT	C	C
	EB T/RT	D	D
	EB APPROACH	D	C
	WB LT	C	C
	WB T	D	D
	WB RT	A	D
	WB APPROACH	C	D
	NB LT	D	D
	NB T	C	D
	NB RT	A	A
	NB APPROACH	C	D
	SB LT	D	D
	SB T	B	C
	SB RT	A	B
	SB APPROACH	C	C
OVERALL	C	D	

TABLE 4
Short Range (2020) Total Peak Hour Operation

Intersection	Movement	Level of Service	
		AM	PM
Taft Hill/Harmony-LCR38E (signal) (Existing Geometry and City Timing)	EB LT	C	C
	EB T/RT	D	D
	EB APPROACH	D	C
	WB LT	C	C
	WB T	D	D
	WB RT	A	D
	WB APPROACH	C	D
	NB LT	D	E (55.5 secs)
	NB T/RT	C	F (66.2 secs)
	NB APPROACH	C	E (64.8 secs)
	SB LT	D	D
	SB T	B	C
	SB RT	A	B
	SB APPROACH	C	C
	OVERALL	C	D
Taft Hill/Harmony-LCR38E (signal) (with NB RT-Lane and Adjusted Timing)	EB LT	C	C
	EB T/RT	D	D
	EB APPROACH	D	C
	WB LT	C	C
	WB T	D	D
	WB RT	A	D
	WB APPROACH	C	D
	NB LT	D	D
	NB T	C	D
	NB RT	A	A
	NB APPROACH	C	D
	SB LT	D	D
	SB T	B	C
	SB RT	A	B
	SB APPROACH	C	C
OVERALL	C	D	
Harmony/Site Access (stop sign)	NB LT/RT	B	C
	WB LT	A	A

APPENDIX A

**Attachment A
Transportation Impact Study
Base Assumptions**

Project Information		
Project Name	HARMONY COTTAGES (HABITAT FOR HUMANITY)	
Project Location	SE QUADRANT OF HARMONY/TAPT HILL	
TIS Assumptions		
Type of Study	Full: NO	Intermediate: MEMO
Study Area Boundaries	North: HARMONY	South: HARMONY
	East: SITE ACCESS	West: TAPT HILL
	Study Years	Short Range: 2020
Future Traffic Growth Rate	2% / YEAR	
Study Intersections	1. All access drives	5.
	2. HARMONY/TAPT HILL	6.
	3.	7.
	4.	8.
Time Period for Study	AM: 7:00-9:00	PM: 4:00-6:00
Sat Noon:	NO	
Trip Generation Rates	PER ITE	
Trip Adjustment Factors	Passby: N/A	Captive Market: N/A
Overall Trip Distribution	SEE ATTACHED SKETCH	
Mode Split Assumptions	N/A	
Committed Roadway Improvements	NOT AWARE OF ANY	
Other Traffic Studies	NOT AWARE OF ANY	
Areas Requiring Special Study		

Date: OCTOBER 29, 2015

Traffic Engineer: DELICH ASSOCIATES

Local Entity Engineer:  10.30.15

1587 BAF

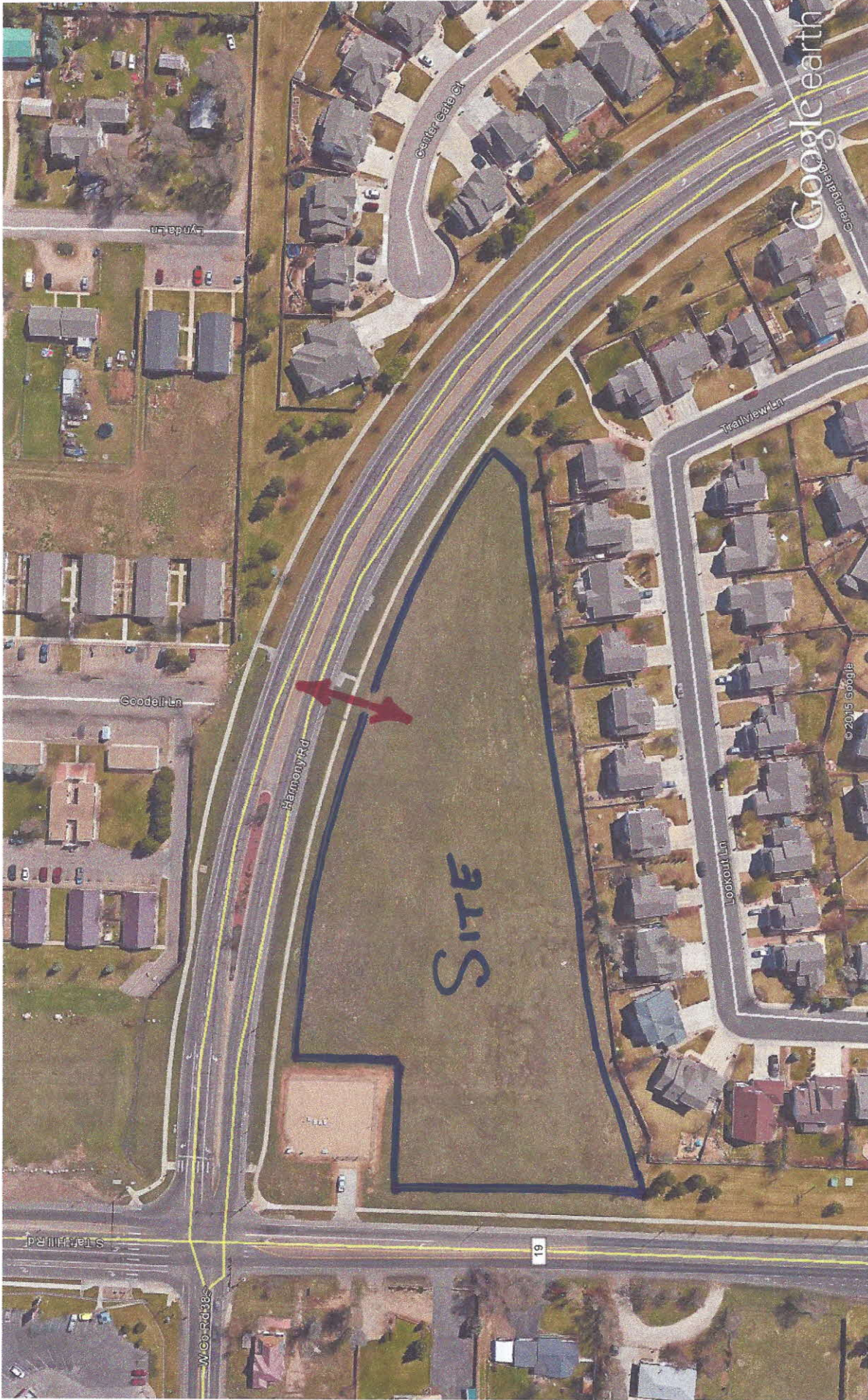

Google earth

feet
meters

900
200

30 S

$$\begin{array}{r} 30\ S \\ 180 \\ \hline 900' \end{array}$$





DESCRIPTION	SPACES	QUANTITY
PRIVATE DRIVE	6	
SPACES ADJACENT TO DRIVEWAYS	35	
GARAGE SPACES	46	
TOTAL OF SPACES		42
UNIT TYPE		
DUPLEX	42	
POLYURE SCHOON DISTRICT BLDG.	4	
TOTAL # OF UNITS		46



GREEN COURT EXAMPLES

RIPLEY
DESIGN INC.

land planning
landscape architecture
urban design
entertainment

HABITAT FOR HUMANITY

CONCEPT E

401 West Mountain Ave, Suite 100
Fort Collins, Colorado 80521
970.224.5828
www.rpleydesigninc.com

TRIP GENERATION (T.G., 9th Ed)

42 DUPLEX D.U. PLUS 4 S.F. D.U. = 46 D.U.

USE CODE Z10

DAILY $L_n(T) = 0.92 L_n X + 2.72 = 514 \text{ TG}$
 $R^2 = 0.95$
RATE (9.52) = 438 TG

AM $T = 0.70 X + 9.74 = 42 \text{ TG}$ IN (25%) = 11
 $R^2 = 0.89$ OUT (75%) = 31
RATE (0.75) = 35 TG

PM $L_n(T) = 0.90 L_n X + 0.51 = 52 \text{ TG}$ IN (63%) = 33
 $R^2 = 0.91$ OUT (37%) = 19
RATE (1.0) = 46 TG

TRIP DISTRIBUTION

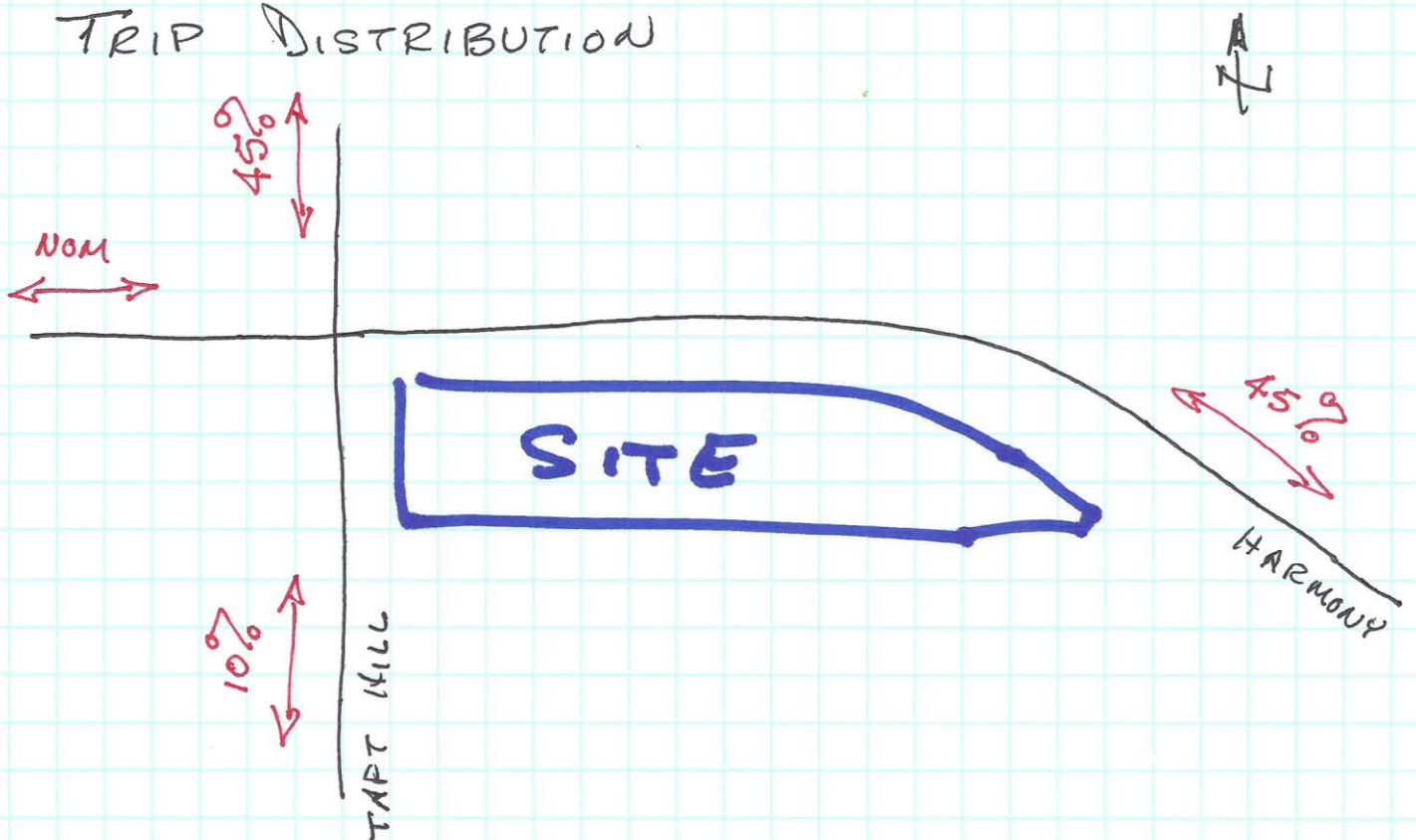

APPENDIX B

DELICH ASSOCIATES
 2272 GLEN HAVEN DRIVE
 LOVELAND, CO 80538
 Phone: (970) 669-2061

TABULAR SUMMARY OF VEHICLE COUNTS

Date: 6/12/2014

Observer: City of Fort Collins

Day: Thursday

Jurisdiction: Fort Collins

Intersection: Taft Hill/Harmony-LCR38E

R = right turn
 S = straight
 L = left turn

Time Begins	Northbound: Taft Hill				Southbound: Taft Hill				Total north/south	Eastbound: LCR38E				Westbound: Harmony				Total east/west	Total All
	L	S	R	Total	L	S	R	Total		L	S	R	Total	L	S	R	Total		
7:30	3	108	16	127	64	139	10	213	340	52	41	26	119	6	16	37	59	178	518
7:45	15	127	19	161	69	132	9	210	371	49	61	13	123	14	8	47	69	192	563
8:00	9	91	5	105	60	96	8	164	269	43	35	10	88	13	11	29	53	141	410
8:15	9	85	10	104	54	109	16	179	283	46	39	10	95	11	11	29	51	146	429

7:30-8:30	36	411	50	497	247	476	43	766	1263	190	176	59	425	44	46	142	232	657	1920
PHF	0.6	0.81	0.66	0.77	0.89	0.86	0.67	0.9		0.91	0.72	0.57	0.86	0.79	0.72	0.76	0.84		0.85

4:30	20	138	9	167	66	114	31	211	378	30	36	14	80	8	51	77	136	216	594
4:45	23	139	11	173	64	146	36	246	419	39	37	13	89	7	64	78	149	238	657
5:00	28	124	15	167	64	126	48	238	405	31	36	9	76	18	49	100	167	243	648
5:15	15	154	9	178	78	137	40	255	433	34	42	16	92	14	53	108	175	267	700























4:30-5:30	86	555	44	685	272	523	155	950	1635	134	151	52	337	47	217	363	627	964	2599
PHF	0.77	0.9	0.73	0.96	0.87	0.9	0.81	0.93		0.86	0.9	0.81	0.92	0.65	0.85	0.84	0.9		0.93

APPENDIX C

HCM 2010 Signalized Intersection Summary

3: Taft Hill & LCR38E/Harmony

Recent AM









												
Movement	EBL	EBT	EBR	WBL	WBT	WBR	NBL	NBT	NBR	SBL	SBT	SBR
Lane Configurations												
Volume (veh/h)	190	176	59	44	46	142	36	411	50	247	476	43
Number	7	4	14	3	8	18	1	6	16	5	2	12
Initial Q (Qb), veh	0	0	0	0	0	0	0	0	0	0	0	0
Ped-Bike Adj(A_pbT)	1.00		1.00	1.00		1.00	1.00		1.00	1.00		1.00
Parking Bus, Adj	1.00	1.00	1.00	1.00	1.00	1.00	1.00	1.00	1.00	1.00	1.00	1.00
Adj Sat Flow, veh/h/ln	1863	1863	1824	1863	1863	1863	1863	1863	1824	1863	1863	1863
Adj Flow Rate, veh/h	224	207	54	52	54	0	42	484	54	291	560	0
Adj No. of Lanes	1	1	0	1	1	1	1	1	0	2	1	1
Peak Hour Factor	0.85	0.85	0.85	0.85	0.85	0.85	0.85	0.85	0.85	0.85	0.85	0.85
Percent Heavy Veh, %	2	2	2	2	2	2	2	2	2	2	2	2
Cap, veh/h	391	251	65	202	207	176	118	695	78	574	1015	862
Arrive On Green	0.11	0.18	0.17	0.05	0.11	0.00	0.07	0.42	0.41	0.17	0.54	0.00
Sat Flow, veh/h	1774	1425	372	1774	1863	1583	1774	1647	184	3442	1863	1583
Grp Volume(v), veh/h	224	0	261	52	54	0	42	0	538	291	560	0
Grp Sat Flow(s),veh/h/ln	1774	0	1797	1774	1863	1583	1774	0	1830	1721	1863	1583
Q Serve(g_s), s	9.8	0.0	12.6	2.3	2.4	0.0	2.0	0.0	21.7	6.9	17.6	0.0
Cycle Q Clear(g_c), s	9.8	0.0	12.6	2.3	2.4	0.0	2.0	0.0	21.7	6.9	17.6	0.0
Prop In Lane	1.00		0.21	1.00		1.00	1.00		0.10	1.00		1.00
Lane Grp Cap(c), veh/h	391	0	317	202	207	176	118	0	773	574	1015	862
V/C Ratio(X)	0.57	0.00	0.82	0.26	0.26	0.00	0.36	0.00	0.70	0.51	0.55	0.00
Avail Cap(c_a), veh/h	391	0	359	258	310	264	177	0	773	574	1015	862
HCM Platoon Ratio	1.00	1.00	1.00	1.00	1.00	1.00	1.00	1.00	1.00	1.00	1.00	1.00
Upstream Filter(I)	1.00	0.00	1.00	1.00	1.00	0.00	1.00	0.00	1.00	1.00	1.00	0.00
Uniform Delay (d), s/veh	29.5	0.0	35.8	33.2	36.6	0.0	40.2	0.0	21.3	34.1	13.3	0.0
Incr Delay (d2), s/veh	2.0	0.0	13.1	0.7	0.7	0.0	1.8	0.0	5.1	0.7	2.2	0.0
Initial Q Delay(d3),s/veh	0.0	0.0	0.0	0.0	0.0	0.0	0.0	0.0	0.0	0.0	0.0	0.0
%ile BackOfQ(50%),veh/ln	4.9	0.0	7.4	1.1	1.3	0.0	1.1	0.0	12.0	3.3	9.6	0.0
LnGrp Delay(d),s/veh	31.6	0.0	48.9	33.9	37.3	0.0	42.0	0.0	26.5	34.8	15.5	0.0
LnGrp LOS	C		D	C	D		D		C	C	B	
Approach Vol, veh/h		485			106			580			851	
Approach Delay, s/veh		40.9			35.6			27.6			22.1	
Approach LOS		D			D			C			C	
Timer	1	2	3	4	5	6	7	8				
Assigned Phs	1	2	3	4	5	6	7	8				
Phs Duration (G+Y+Rc), s	9.0	53.0	7.1	20.9	19.0	43.0	13.0	15.0				
Change Period (Y+Rc), s	4.0	5.0	4.0	6.0	5.0	6.0	4.0	6.0				
Max Green Setting (Gmax), s	8.0	40.0	6.0	17.0	9.0	37.0	9.0	14.0				
Max Q Clear Time (g_c+I1), s	4.0	19.6	4.3	14.6	8.9	23.7	11.8	4.4				
Green Ext Time (p_c), s	0.0	3.0	0.0	0.2	0.0	1.6	0.0	0.7				
Intersection Summary												
HCM 2010 Ctrl Delay			28.9									
HCM 2010 LOS			C									

Notes

User approved pedestrian interval to be less than phase max green.

Timing Report, Sorted By Phase
3: Taft Hill & LCR38E/Harmony

Recent AM

								
Phase Number	1	2	3	4	5	6	7	8
Movement	NBL	SBT	WBL	EBTL	SBL	NBT	EBL	WBTL
Lead/Lag	Lead	Lag	Lead	Lag	Lag	Lead	Lead	Lag
Lead-Lag Optimize	Yes	Yes			Yes	Yes		
Recall Mode	None	C-Max	None	None	None	Max	None	None
Maximum Split (s)	12	45	10	23	14	43	13	20
Maximum Split (%)	13.3%	50.0%	11.1%	25.6%	15.6%	47.8%	14.4%	22.2%
Minimum Split (s)	11	23	10	23	11	26	11	20
Yellow Time (s)	3	4	3	4.5	3	4.5	3	4.5
All-Red Time (s)	1	1	1	1.5	2	1.5	1	1.5
Minimum Initial (s)	5	7	4	7	4	7	4	7
Vehicle Extension (s)	3	3	3	3	3	3	3	3
Minimum Gap (s)	3	3	3	3	3	3	3	3
Time Before Reduce (s)	0	0	0	0	0	0	0	0
Time To Reduce (s)	0	0	0	0	0	0	0	0
Walk Time (s)		7		7		7		7
Flash Dont Walk (s)		10		12		13		15
Dual Entry	Yes	Yes	No	Yes	No	Yes	No	Yes
Inhibit Max	Yes	Yes	Yes	Yes	Yes	Yes	Yes	Yes
Start Time (s)	88	10	55	65	41	88	55	68
End Time (s)	10	55	65	88	55	41	68	88
Yield/Force Off (s)	6	50	61	82	50	35	64	82
Yield/Force Off 170(s)	6	40	61	70	50	22	64	67
Local Start Time (s)	33	45	0	10	76	33	0	13
Local Yield (s)	41	85	6	27	85	70	9	27
Local Yield 170(s)	41	75	6	15	85	57	9	12

Intersection Summary





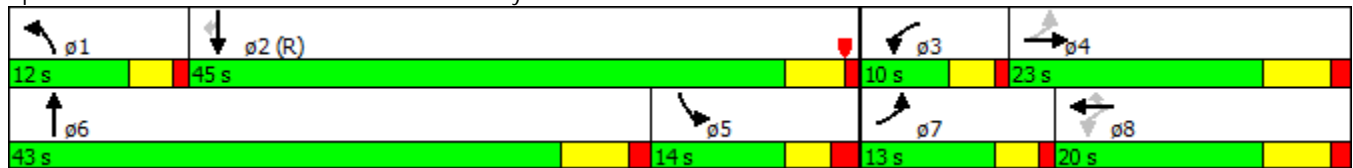

















Cycle Length 90
 Control Type Actuated-Coordinated
 Natural Cycle 75
 Offset: 55 (61%), Referenced to phase 2:SBT, Start of Red

Splits and Phases: 3: Taft Hill & LCR38E/Harmony



HCM 2010 Signalized Intersection Summary
 3: Taft Hill & LCR38E/Harmony

Recent PM

												
Movement	EBL	EBT	EBR	WBL	WBT	WBR	NBL	NBT	NBR	SBL	SBT	SBR
Lane Configurations												
Volume (veh/h)	134	151	52	47	217	363	86	555	44	272	523	155
Number	7	4	14	3	8	18	1	6	16	5	2	12
Initial Q (Qb), veh	0	0	0	0	0	0	0	0	0	0	0	0
Ped-Bike Adj(A_pbT)	1.00		1.00	1.00		1.00	1.00		1.00	1.00		1.00
Parking Bus, Adj	1.00	1.00	1.00	1.00	1.00	1.00	1.00	1.00	1.00	1.00	1.00	1.00
Adj Sat Flow, veh/h/ln	1863	1863	1824	1863	1863	1863	1863	1863	1824	1863	1863	1863
Adj Flow Rate, veh/h	144	162	42	51	233	76	92	597	44	292	562	76
Adj No. of Lanes	1	1	0	1	1	1	1	1	0	2	1	1
Peak Hour Factor	0.93	0.93	0.93	0.93	0.93	0.93	0.93	0.93	0.93	0.93	0.93	0.93
Percent Heavy Veh, %	2	2	2	2	2	2	2	2	2	2	2	2
Cap, veh/h	272	291	75	273	304	258	145	668	49	634	955	812
Arrive On Green	0.08	0.20	0.19	0.04	0.16	0.16	0.08	0.39	0.38	0.18	0.51	0.51
Sat Flow, veh/h	1774	1427	370	1774	1863	1583	1774	1714	126	3442	1863	1583
Grp Volume(v), veh/h	144	0	204	51	233	76	92	0	641	292	562	76
Grp Sat Flow(s),veh/h/ln	1774	0	1797	1774	1863	1583	1774	0	1840	1721	1863	1583
Q Serve(g_s), s	6.1	0.0	9.7	2.2	11.4	4.0	4.8	0.0	31.0	7.2	20.0	2.3
Cycle Q Clear(g_c), s	6.1	0.0	9.7	2.2	11.4	4.0	4.8	0.0	31.0	7.2	20.0	2.3
Prop In Lane	1.00		0.21	1.00		1.00	1.00		0.07	1.00		1.00
Lane Grp Cap(c), veh/h	272	0	366	273	304	258	145	0	717	634	955	812
V/C Ratio(X)	0.53	0.00	0.56	0.19	0.77	0.29	0.63	0.00	0.89	0.46	0.59	0.09
Avail Cap(c_a), veh/h	272	0	435	345	451	383	149	0	717	634	955	812
HCM Platoon Ratio	1.00	1.00	1.00	1.00	1.00	1.00	1.00	1.00	1.00	1.00	1.00	1.00
Upstream Filter(I)	1.00	0.00	1.00	1.00	1.00	1.00	1.00	0.00	1.00	1.00	1.00	1.00
Uniform Delay (d), s/veh	28.8	0.0	34.1	31.0	38.0	34.9	42.2	0.0	27.2	34.5	16.1	11.8
Incr Delay (d2), s/veh	2.0	0.0	1.3	0.3	4.5	0.6	8.1	0.0	15.9	0.5	2.7	0.2
Initial Q Delay(d3),s/veh	0.0	0.0	0.0	0.0	0.0	0.0	0.0	0.0	0.0	0.0	0.0	0.0
%ile BackOfQ(50%),veh/ln	3.1	0.0	5.0	1.1	6.2	1.8	2.7	0.0	18.8	3.5	10.9	1.1
LnGrp Delay(d),s/veh	30.7	0.0	35.4	31.3	42.5	35.6	50.4	0.0	43.1	35.1	18.8	12.1
LnGrp LOS	C		D	C	D	D	D		D	D	B	B
Approach Vol, veh/h		348			360			733			930	
Approach Delay, s/veh		33.4			39.5			44.0			23.4	
Approach LOS		C			D			D			C	
Timer	1	2	3	4	5	6	7	8				
Assigned Phs	1	2	3	4	5	6	7	8				
Phs Duration (G+Y+Rc), s	10.8	52.7	7.1	24.4	21.5	42.0	11.0	20.5				
Change Period (Y+Rc), s	4.0	5.0	4.0	6.0	5.0	6.0	4.0	6.0				
Max Green Setting (Gmax), s	7.0	40.0	7.0	22.0	9.0	36.0	7.0	22.0				
Max Q Clear Time (g_c+I1), s	6.8	22.0	4.2	11.7	9.2	33.0	8.1	13.4				
Green Ext Time (p_c), s	0.0	3.2	0.0	1.2	0.0	0.8	0.0	1.1				
Intersection Summary												
HCM 2010 Ctrl Delay			33.7									
HCM 2010 LOS			C									
Notes												
User approved pedestrian interval to be less than phase max green.												

Timing Report, Sorted By Phase
3: Taft Hill & LCR38E/Harmony

Recent PM

Phase Number	1	2	3	4	5	6	7	8
Movement	NBL	SBT	WBL	EBTL	SBL	NBT	EBL	WBTL
Lead/Lag	Lead	Lag	Lead	Lag	Lag	Lead	Lead	Lag
Lead-Lag Optimize	Yes	Yes			Yes	Yes		
Recall Mode	None	C-Max	None	None	None	C-Max	None	None
Maximum Split (s)	11	45	11	28	14	42	11	28
Maximum Split (%)	11.6%	47.4%	11.6%	29.5%	14.7%	44.2%	11.6%	29.5%
Minimum Split (s)	11	23	10	25	11	26	11	28
Yellow Time (s)	3	4	3	4.5	3	4.5	3	4.5
All-Red Time (s)	1	1	1	1.5	2	1.5	1	1.5
Minimum Initial (s)	5	7	4	7	4	7	4	7
Vehicle Extension (s)	3	3	3	3	3	3	3	3
Minimum Gap (s)	3	3	3	3	3	3	3	3
Time Before Reduce (s)	0	0	0	0	0	0	0	0
Time To Reduce (s)	0	0	0	0	0	0	0	0
Walk Time (s)		7		7		7		7
Flash Dont Walk (s)		10		12		13		15
Dual Entry	Yes	Yes	No	Yes	No	Yes	No	Yes
Inhibit Max	Yes	Yes	Yes	Yes	Yes	Yes	Yes	Yes
Start Time (s)	10	21	66	77	52	10	66	77
End Time (s)	21	66	77	10	66	52	77	10
Yield/Force Off (s)	17	61	73	4	61	46	73	4
Yield/Force Off 170(s)	17	51	73	87	61	33	73	84
Local Start Time (s)	53	64	14	25	0	53	14	25
Local Yield (s)	60	9	21	47	9	89	21	47
Local Yield 170(s)	60	94	21	35	9	76	21	32

Intersection Summary

Cycle Length 95
 Control Type Actuated-Coordinated
 Natural Cycle 90
 Offset: 52 (55%), Referenced to phase 2:SBT and 6:NBT, Start of Red

Splits and Phases: 3: Taft Hill & LCR38E/Harmony

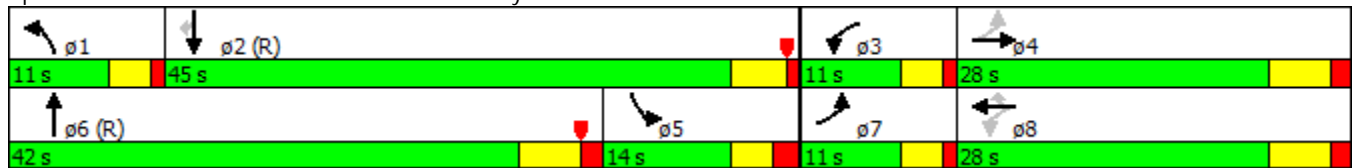

UNSIGNALIZED INTERSECTIONS

Level-of-Service	Average Total Delay sec/veh
A	≤ 10
B	> 10 and ≤ 15
C	> 15 and ≤ 25
D	> 25 and ≤ 35
E	> 35 and ≤ 50
F	> 50

SIGNALIZED INTERSECTIONS

Level-of-Service	Average Total Delay sec/veh
A	≤ 10
B	> 10 and ≤ 20
C	> 20 and ≤ 35
D	> 35 and ≤ 55
E	> 55 and ≤ 80
F	> 80

**Table 4-3
Fort Collins (GMA and City Limits)
Motor Vehicle LOS Standards (Intersections)**























Intersection type	Land Use (from structure plan)			
	Commercial corridors	Other corridors within:		
		Mixed use districts	Low density mixed use residential	All other areas
Signalized intersections (overall)	D	E*	D	D
Any Leg	E	E	D	E
Any Movement	E	E	D	E
Stop sign control (arterial/arterial, arterial/collector or local-any approach leg)	N/A	F**	F**	E
Stop sign control (collector/local--any approach leg)	N/A	C	C	C
* mitigating measures required ** considered normal in an urban environment				

APPENDIX D

HCM 2010 Signalized Intersection Summary

3: Taft Hill & LCR38E/Harmony

Short Bkgrd AM









												
Movement	EBL	EBT	EBR	WBL	WBT	WBR	NBL	NBT	NBR	SBL	SBT	SBR
Lane Configurations												
Volume (veh/h)	214	198	66	50	52	160	41	463	56	278	536	48
Number	7	4	14	3	8	18	1	6	16	5	2	12
Initial Q (Qb), veh	0	0	0	0	0	0	0	0	0	0	0	0
Ped-Bike Adj(A_pbT)	1.00		1.00	1.00		1.00	1.00		1.00	1.00		1.00
Parking Bus, Adj	1.00	1.00	1.00	1.00	1.00	1.00	1.00	1.00	1.00	1.00	1.00	1.00
Adj Sat Flow, veh/h/ln	1863	1863	1824	1863	1863	1863	1863	1863	1824	1863	1863	1863
Adj Flow Rate, veh/h	252	233	63	59	61	0	48	545	61	327	631	0
Adj No. of Lanes	1	1	0	1	1	1	1	1	0	2	1	1
Peak Hour Factor	0.85	0.85	0.85	0.85	0.85	0.85	0.85	0.85	0.85	0.85	0.85	0.85
Percent Heavy Veh, %	2	2	2	2	2	2	2	2	2	2	2	2
Cap, veh/h	415	274	74	206	247	210	118	695	78	500	974	828
Arrive On Green	0.11	0.19	0.18	0.05	0.13	0.00	0.07	0.42	0.41	0.15	0.52	0.00
Sat Flow, veh/h	1774	1413	382	1774	1863	1583	1774	1646	184	3442	1863	1583
Grp Volume(v), veh/h	252	0	296	59	61	0	48	0	606	327	631	0
Grp Sat Flow(s),veh/h/ln	1774	0	1795	1774	1863	1583	1774	0	1830	1721	1863	1583
Q Serve(g_s), s	10.0	0.0	14.3	2.5	2.6	0.0	2.3	0.0	25.8	8.1	22.0	0.0
Cycle Q Clear(g_c), s	10.0	0.0	14.3	2.5	2.6	0.0	2.3	0.0	25.8	8.1	22.0	0.0
Prop In Lane	1.00		0.21	1.00		1.00	1.00		0.10	1.00		1.00
Lane Grp Cap(c), veh/h	415	0	348	206	247	210	118	0	773	500	974	828
V/C Ratio(X)	0.61	0.00	0.85	0.29	0.25	0.00	0.41	0.00	0.78	0.65	0.65	0.00
Avail Cap(c_a), veh/h	415	0	359	255	310	264	177	0	773	500	974	828
HCM Platoon Ratio	1.00	1.00	1.00	1.00	1.00	1.00	1.00	1.00	1.00	1.00	1.00	1.00
Upstream Filter(I)	1.00	0.00	1.00	1.00	1.00	0.00	1.00	0.00	1.00	1.00	1.00	0.00
Uniform Delay (d), s/veh	28.8	0.0	35.1	31.6	35.0	0.0	40.3	0.0	22.5	36.3	15.5	0.0
Incr Delay (d2), s/veh	2.5	0.0	17.1	0.8	0.5	0.0	2.2	0.0	7.8	3.1	3.3	0.0
Initial Q Delay(d3),s/veh	0.0	0.0	0.0	0.0	0.0	0.0	0.0	0.0	0.0	0.0	0.0	0.0
%ile BackOfQ(50%),veh/ln	1.1	0.0	8.7	1.3	1.4	0.0	1.2	0.0	14.6	4.0	12.1	0.0
LnGrp Delay(d),s/veh	31.3	0.0	52.3	32.3	35.5	0.0	42.5	0.0	30.3	39.4	18.8	0.0
LnGrp LOS	C		D	C	D		D		C	D	B	
Approach Vol, veh/h		548			120			654			958	
Approach Delay, s/veh		42.6			33.9			31.2			25.8	
Approach LOS		D			C			C			C	
Timer	1	2	3	4	5	6	7	8				
Assigned Phs	1	2	3	4	5	6	7	8				
Phs Duration (G+Y+Rc), s	9.0	51.1	7.5	22.4	17.1	43.0	13.0	16.9				
Change Period (Y+Rc), s	4.0	5.0	4.0	6.0	5.0	6.0	4.0	6.0				
Max Green Setting (Gmax), s	8.0	40.0	6.0	17.0	9.0	37.0	9.0	14.0				
Max Q Clear Time (g_c+I1), s	4.3	24.0	4.5	16.3	10.1	27.8	12.0	4.6				
Green Ext Time (p_c), s	0.0	3.3	0.0	0.1	0.0	1.6	0.0	0.8				
Intersection Summary												
HCM 2010 Ctrl Delay			31.9									
HCM 2010 LOS			C									

Notes

User approved pedestrian interval to be less than phase max green.

Timing Report, Sorted By Phase
3: Taft Hill & LCR38E/Harmony

Short Bkgrd AM

								
Phase Number	1	2	3	4	5	6	7	8
Movement	NBL	SBT	WBL	EBTL	SBL	NBT	EBL	WBTL
Lead/Lag	Lead	Lag	Lead	Lag	Lag	Lead	Lead	Lag
Lead-Lag Optimize	Yes	Yes			Yes	Yes		
Recall Mode	None	C-Max	None	None	None	Max	None	None
Maximum Split (s)	12	45	10	23	14	43	13	20
Maximum Split (%)	13.3%	50.0%	11.1%	25.6%	15.6%	47.8%	14.4%	22.2%
Minimum Split (s)	11	23	10	23	11	26	11	20
Yellow Time (s)	3	4	3	4.5	3	4.5	3	4.5
All-Red Time (s)	1	1	1	1.5	2	1.5	1	1.5
Minimum Initial (s)	5	7	4	7	4	7	4	7
Vehicle Extension (s)	3	3	3	3	3	3	3	3
Minimum Gap (s)	3	3	3	3	3	3	3	3
Time Before Reduce (s)	0	0	0	0	0	0	0	0
Time To Reduce (s)	0	0	0	0	0	0	0	0
Walk Time (s)		7		7		7		7
Flash Dont Walk (s)		10		12		13		15
Dual Entry	Yes	Yes	No	Yes	No	Yes	No	Yes
Inhibit Max	Yes	Yes	Yes	Yes	Yes	Yes	Yes	Yes
Start Time (s)	44.5	56.5	11.5	21.5	87.5	44.5	11.5	24.5
End Time (s)	56.5	11.5	21.5	44.5	11.5	87.5	24.5	44.5
Yield/Force Off (s)	52.5	6.5	17.5	38.5	6.5	81.5	20.5	38.5
Yield/Force Off 170(s)	52.5	86.5	17.5	26.5	6.5	68.5	20.5	23.5
Local Start Time (s)	33	45	0	10	76	33	0	13
Local Yield (s)	41	85	6	27	85	70	9	27
Local Yield 170(s)	41	75	6	15	85	57	9	12

Intersection Summary

Cycle Length 90
 Control Type Actuated-Coordinated
 Natural Cycle 80
 Offset: 11.5 (13%), Referenced to phase 2:SBT, Start of Red



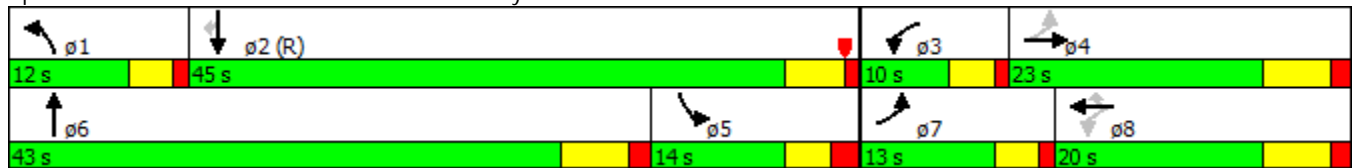



















Splits and Phases: 3: Taft Hill & LCR38E/Harmony



HCM 2010 Signalized Intersection Summary

3: Taft Hill & LCR38E/Harmony

Short Bkgrd PM

												
Movement	EBL	EBT	EBR	WBL	WBT	WBR	NBL	NBT	NBR	SBL	SBT	SBR
Lane Configurations												
Volume (veh/h)	151	170	59	53	244	409	97	625	50	306	589	175
Number	7	4	14	3	8	18	1	6	16	5	2	12
Initial Q (Qb), veh	0	0	0	0	0	0	0	0	0	0	0	0
Ped-Bike Adj(A_pbT)	1.00		1.00	1.00		1.00	1.00		1.00	1.00		1.00
Parking Bus, Adj	1.00	1.00	1.00	1.00	1.00	1.00	1.00	1.00	1.00	1.00	1.00	1.00
Adj Sat Flow, veh/h/ln	1863	1863	1824	1863	1863	1863	1863	1863	1824	1863	1863	1863
Adj Flow Rate, veh/h	162	183	49	57	262	158	104	672	51	329	633	78
Adj No. of Lanes	1	1	0	1	1	1	1	1	0	2	1	1
Peak Hour Factor	0.93	0.93	0.93	0.93	0.93	0.93	0.93	0.93	0.93	0.93	0.93	0.93
Percent Heavy Veh, %	2	2	2	2	2	2	2	2	2	2	2	2
Cap, veh/h	270	308	82	275	336	285	149	666	51	575	919	781
Arrive On Green	0.08	0.22	0.21	0.05	0.18	0.18	0.08	0.39	0.38	0.17	0.49	0.49
Sat Flow, veh/h	1774	1417	379	1774	1863	1583	1774	1710	130	3442	1863	1583
Grp Volume(v), veh/h	162	0	232	57	262	158	104	0	723	329	633	78
Grp Sat Flow(s),veh/h/ln	1774	0	1796	1774	1863	1583	1774	0	1840	1721	1863	1583
Q Serve(g_s), s	6.8	0.0	11.0	2.4	12.7	8.6	5.4	0.0	37.0	8.4	24.8	2.5
Cycle Q Clear(g_c), s	6.8	0.0	11.0	2.4	12.7	8.6	5.4	0.0	37.0	8.4	24.8	2.5
Prop In Lane	1.00		0.21	1.00		1.00	1.00		0.07	1.00		1.00
Lane Grp Cap(c), veh/h	270	0	391	275	336	285	149	0	717	575	919	781
V/C Ratio(X)	0.60	0.00	0.59	0.21	0.78	0.55	0.70	0.00	1.01	0.57	0.69	0.10
Avail Cap(c_a), veh/h	270	0	435	341	451	383	149	0	717	575	919	781
HCM Platoon Ratio	1.00	1.00	1.00	1.00	1.00	1.00	1.00	1.00	1.00	1.00	1.00	1.00
Upstream Filter(I)	1.00	0.00	1.00	1.00	1.00	1.00	1.00	0.00	1.00	1.00	1.00	1.00
Uniform Delay (d), s/veh	28.1	0.0	33.5	29.6	37.1	35.5	42.3	0.0	29.0	36.4	18.5	12.8
Incr Delay (d2), s/veh	3.7	0.0	1.8	0.4	6.1	1.7	13.2	0.0	35.9	1.4	4.2	0.3
Initial Q Delay(d3),s/veh	0.0	0.0	0.0	0.0	0.0	0.0	0.0	0.0	0.0	0.0	0.0	0.0
%ile BackOfQ(50%),veh/ln	3.6	0.0	5.7	1.2	7.1	3.9	3.2	0.0	25.8	4.1	13.7	1.1
LnGrp Delay(d),s/veh	31.7	0.0	35.3	30.0	43.3	37.1	55.5	0.0	64.9	37.8	22.7	13.1
LnGrp LOS	C		D	C	D	D	E		F	D	C	B
Approach Vol, veh/h		394			477			827			1040	
Approach Delay, s/veh		33.8			39.7			63.7			26.7	
Approach LOS		C			D			E			C	
Timer	1	2	3	4	5	6	7	8				
Assigned Phs	1	2	3	4	5	6	7	8				
Phs Duration (G+Y+Rc), s	11.0	50.9	7.5	25.7	19.9	42.0	11.0	22.1				
Change Period (Y+Rc), s	4.0	5.0	4.0	6.0	5.0	6.0	4.0	6.0				
Max Green Setting (Gmax), s	7.0	40.0	7.0	22.0	9.0	36.0	7.0	22.0				
Max Q Clear Time (g_c+I1), s	7.4	26.8	4.4	13.0	10.4	39.0	8.8	14.7				
Green Ext Time (p_c), s	0.0	3.4	0.0	1.6	0.0	0.0	0.0	1.4				

Intersection Summary









HCM 2010 Ctrl Delay	41.2
HCM 2010 LOS	D

Notes

User approved pedestrian interval to be less than phase max green.

Timing Report, Sorted By Phase
3: Taft Hill & LCR38E/Harmony

Short Bkgrd PM

								
Phase Number	1	2	3	4	5	6	7	8
Movement	NBL	SBT	WBL	EBTL	SBL	NBT	EBL	WBTL
Lead/Lag	Lead	Lag	Lead	Lag	Lag	Lead	Lead	Lag
Lead-Lag Optimize	Yes	Yes			Yes	Yes		
Recall Mode	None	C-Max	None	None	None	C-Max	None	None
Maximum Split (s)	11	45	11	28	14	42	11	28
Maximum Split (%)	11.6%	47.4%	11.6%	29.5%	14.7%	44.2%	11.6%	29.5%
Minimum Split (s)	11	23	10	25	11	26	11	28
Yellow Time (s)	3	4	3	4.5	3	4.5	3	4.5
All-Red Time (s)	1	1	1	1.5	2	1.5	1	1.5
Minimum Initial (s)	5	7	4	7	4	7	4	7
Vehicle Extension (s)	3	3	3	3	3	3	3	3
Minimum Gap (s)	3	3	3	3	3	3	3	3
Time Before Reduce (s)	0	0	0	0	0	0	0	0
Time To Reduce (s)	0	0	0	0	0	0	0	0
Walk Time (s)		7		7		7		7
Flash Dont Walk (s)		10		12		13		15
Dual Entry	Yes	Yes	No	Yes	No	Yes	No	Yes
Inhibit Max	Yes	Yes	Yes	Yes	Yes	Yes	Yes	Yes
Start Time (s)	10	21	66	77	52	10	66	77
End Time (s)	21	66	77	10	66	52	77	10
Yield/Force Off (s)	17	61	73	4	61	46	73	4
Yield/Force Off 170(s)	17	51	73	87	61	33	73	84
Local Start Time (s)	53	64	14	25	0	53	14	25
Local Yield (s)	60	9	21	47	9	89	21	47
Local Yield 170(s)	60	94	21	35	9	76	21	32

Intersection Summary





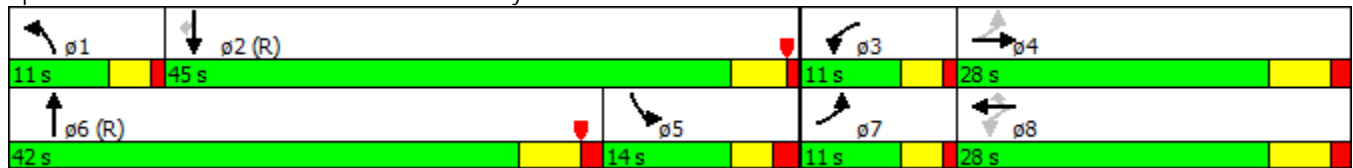

















Cycle Length 95
 Control Type Actuated-Coordinated
 Natural Cycle 90
 Offset: 52 (55%), Referenced to phase 2:SBT and 6:NBT, Start of Red

Splits and Phases: 3: Taft Hill & LCR38E/Harmony



HCM 2010 Signalized Intersection Summary
 3: Taft Hill & LCR38E/Harmony

Short Bkgrd AM
 NB RT-Lane









												
Movement	EBL	EBT	EBR	WBL	WBT	WBR	NBL	NBT	NBR	SBL	SBT	SBR
Lane Configurations												
Volume (veh/h)	214	198	66	50	52	160	41	463	56	278	536	48
Number	7	4	14	3	8	18	1	6	16	5	2	12
Initial Q (Qb), veh	0	0	0	0	0	0	0	0	0	0	0	0
Ped-Bike Adj(A_pbT)	1.00		1.00	1.00		1.00	1.00		1.00	1.00		1.00
Parking Bus, Adj	1.00	1.00	1.00	1.00	1.00	1.00	1.00	1.00	1.00	1.00	1.00	1.00
Adj Sat Flow, veh/h/ln	1863	1863	1824	1863	1863	1863	1863	1863	1788	1863	1863	1863
Adj Flow Rate, veh/h	252	233	63	59	61	0	48	545	0	327	631	0
Adj No. of Lanes	1	1	0	1	1	1	1	1	1	2	1	1
Peak Hour Factor	0.85	0.85	0.85	0.85	0.85	0.85	0.85	0.85	0.85	0.85	0.85	0.85
Percent Heavy Veh, %	2	2	2	2	2	2	2	2	2	2	2	2
Cap, veh/h	415	274	74	206	247	210	118	786	625	500	974	828
Arrive On Green	0.11	0.19	0.18	0.05	0.13	0.00	0.07	0.42	0.00	0.15	0.52	0.00
Sat Flow, veh/h	1774	1413	382	1774	1863	1583	1774	1863	1520	3442	1863	1583
Grp Volume(v), veh/h	252	0	296	59	61	0	48	545	0	327	631	0
Grp Sat Flow(s),veh/h/ln	1774	0	1795	1774	1863	1583	1774	1863	1520	1721	1863	1583
Q Serve(g_s), s	10.0	0.0	14.3	2.5	2.6	0.0	2.3	21.5	0.0	8.1	22.0	0.0
Cycle Q Clear(g_c), s	10.0	0.0	14.3	2.5	2.6	0.0	2.3	21.5	0.0	8.1	22.0	0.0
Prop In Lane	1.00		0.21	1.00		1.00	1.00		1.00	1.00		1.00
Lane Grp Cap(c), veh/h	415	0	348	206	247	210	118	786	625	500	974	828
V/C Ratio(X)	0.61	0.00	0.85	0.29	0.25	0.00	0.41	0.69	0.00	0.65	0.65	0.00
Avail Cap(c_a), veh/h	415	0	359	255	310	264	177	786	625	500	974	828
HCM Platoon Ratio	1.00	1.00	1.00	1.00	1.00	1.00	1.00	1.00	1.00	1.00	1.00	1.00
Upstream Filter(I)	1.00	0.00	1.00	1.00	1.00	0.00	1.00	1.00	0.00	1.00	1.00	0.00
Uniform Delay (d), s/veh	28.8	0.0	35.1	31.6	35.0	0.0	40.3	21.2	0.0	36.3	15.5	0.0
Incr Delay (d2), s/veh	2.5	0.0	17.1	0.8	0.5	0.0	2.2	5.0	0.0	3.1	3.3	0.0
Initial Q Delay(d3),s/veh	0.0	0.0	0.0	0.0	0.0	0.0	0.0	0.0	0.0	0.0	0.0	0.0
%ile BackOfQ(50%),veh/ln	1.1	0.0	8.7	1.3	1.4	0.0	1.2	12.1	0.0	4.0	12.1	0.0
LnGrp Delay(d),s/veh	31.3	0.0	52.3	32.3	35.5	0.0	42.5	26.2	0.0	39.4	18.8	0.0
LnGrp LOS	C		D	C	D		D	C		D	B	
Approach Vol, veh/h		548			120			593			958	
Approach Delay, s/veh		42.6			33.9			27.5			25.8	
Approach LOS		D			C			C			C	
Timer	1	2	3	4	5	6	7	8				
Assigned Phs	1	2	3	4	5	6	7	8				
Phs Duration (G+Y+Rc), s	9.0	51.1	7.5	22.4	17.1	43.0	13.0	16.9				
Change Period (Y+Rc), s	4.0	5.0	4.0	6.0	5.0	6.0	4.0	6.0				
Max Green Setting (Gmax), s	8.0	40.0	6.0	17.0	9.0	37.0	9.0	14.0				
Max Q Clear Time (g_c+I1), s	4.3	24.0	4.5	16.3	10.1	23.5	12.0	4.6				
Green Ext Time (p_c), s	0.0	3.3	0.0	0.1	0.0	1.6	0.0	0.8				

Intersection Summary
 HCM 2010 Ctrl Delay 30.9
 HCM 2010 LOS C

Notes
 User approved pedestrian interval to be less than phase max green.

Timing Report, Sorted By Phase
3: Taft Hill & LCR38E/Harmony

Short Bkgrd AM
NB RT-Lane

								
Phase Number	1	2	3	4	5	6	7	8
Movement	NBL	SBT	WBL	EBTL	SBL	NBT	EBL	WBTL
Lead/Lag	Lead	Lag	Lead	Lag	Lag	Lead	Lead	Lag
Lead-Lag Optimize	Yes	Yes			Yes	Yes		
Recall Mode	None	C-Max	None	None	None	Max	None	None
Maximum Split (s)	12	45	10	23	14	43	13	20
Maximum Split (%)	13.3%	50.0%	11.1%	25.6%	15.6%	47.8%	14.4%	22.2%
Minimum Split (s)	11	23	10	23	11	26	11	20
Yellow Time (s)	3	4	3	4.5	3	4.5	3	4.5
All-Red Time (s)	1	1	1	1.5	2	1.5	1	1.5
Minimum Initial (s)	5	7	4	7	4	7	4	7
Vehicle Extension (s)	3	3	3	3	3	3	3	3
Minimum Gap (s)	3	3	3	3	3	3	3	3
Time Before Reduce (s)	0	0	0	0	0	0	0	0
Time To Reduce (s)	0	0	0	0	0	0	0	0
Walk Time (s)		7		7		7		7
Flash Dont Walk (s)		10		12		13		15
Dual Entry	Yes	Yes	No	Yes	No	Yes	No	Yes
Inhibit Max	Yes	Yes	Yes	Yes	Yes	Yes	Yes	Yes
Start Time (s)	44.5	56.5	11.5	21.5	87.5	44.5	11.5	24.5
End Time (s)	56.5	11.5	21.5	44.5	11.5	87.5	24.5	44.5
Yield/Force Off (s)	52.5	6.5	17.5	38.5	6.5	81.5	20.5	38.5
Yield/Force Off 170(s)	52.5	86.5	17.5	26.5	6.5	68.5	20.5	23.5
Local Start Time (s)	33	45	0	10	76	33	0	13
Local Yield (s)	41	85	6	27	85	70	9	27
Local Yield 170(s)	41	75	6	15	85	57	9	12

Intersection Summary

Cycle Length 90
 Control Type Actuated-Coordinated
 Natural Cycle 75
 Offset: 11.5 (13%), Referenced to phase 2:SBT, Start of Red



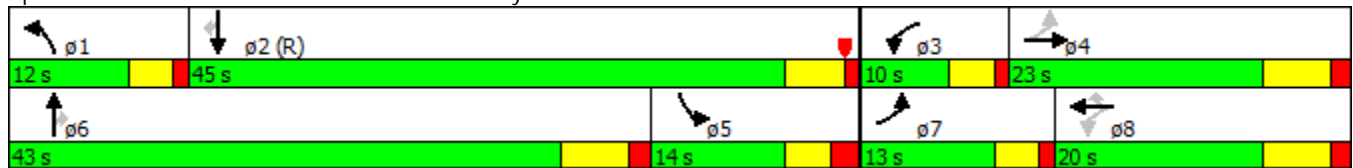



















Splits and Phases: 3: Taft Hill & LCR38E/Harmony



HCM 2010 Signalized Intersection Summary

3: Taft Hill & LCR38E/Harmony

Short Bkgrd PM
NB RT-Lane

												
Movement	EBL	EBT	EBR	WBL	WBT	WBR	NBL	NBT	NBR	SBL	SBT	SBR
Lane Configurations												
Volume (veh/h)	151	170	59	53	244	409	97	625	50	306	589	175
Number	7	4	14	3	8	18	1	6	16	5	2	12
Initial Q (Qb), veh	0	0	0	0	0	0	0	0	0	0	0	0
Ped-Bike Adj(A_pbT)	1.00		1.00	1.00		1.00	1.00		1.00	1.00		1.00
Parking Bus, Adj	1.00	1.00	1.00	1.00	1.00	1.00	1.00	1.00	1.00	1.00	1.00	1.00
Adj Sat Flow, veh/h/ln	1863	1863	1824	1863	1863	1863	1863	1863	1788	1863	1863	1863
Adj Flow Rate, veh/h	162	183	49	57	262	171	104	672	0	329	633	77
Adj No. of Lanes	1	1	0	1	1	1	1	1	1	2	1	1
Peak Hour Factor	0.93	0.93	0.93	0.93	0.93	0.93	0.93	0.93	0.93	0.93	0.93	0.93
Percent Heavy Veh, %	2	2	2	2	2	2	2	2	2	2	2	2
Cap, veh/h	269	309	83	275	336	286	157	745	608	538	910	774
Arrive On Green	0.08	0.22	0.21	0.05	0.18	0.18	0.09	0.40	0.00	0.16	0.49	0.49
Sat Flow, veh/h	1774	1417	379	1774	1863	1583	1774	1863	1520	3442	1863	1583
Grp Volume(v), veh/h	162	0	232	57	262	171	104	672	0	329	633	77
Grp Sat Flow(s),veh/h/ln	1774	0	1796	1774	1863	1583	1774	1863	1520	1721	1863	1583
Q Serve(g_s), s	6.8	0.0	11.0	2.4	12.7	9.4	5.4	32.2	0.0	8.5	25.0	2.5
Cycle Q Clear(g_c), s	6.8	0.0	11.0	2.4	12.7	9.4	5.4	32.2	0.0	8.5	25.0	2.5
Prop In Lane	1.00		0.21	1.00		1.00	1.00		1.00	1.00		1.00
Lane Grp Cap(c), veh/h	269	0	391	275	336	286	157	745	608	538	910	774
V/C Ratio(X)	0.60	0.00	0.59	0.21	0.78	0.60	0.66	0.90	0.00	0.61	0.70	0.10
Avail Cap(c_a), veh/h	269	0	435	341	451	383	168	745	608	538	910	774
HCM Platoon Ratio	1.00	1.00	1.00	1.00	1.00	1.00	1.00	1.00	1.00	1.00	1.00	1.00
Upstream Filter(I)	1.00	0.00	1.00	1.00	1.00	1.00	1.00	1.00	0.00	1.00	1.00	1.00
Uniform Delay (d), s/veh	28.0	0.0	33.5	29.6	37.1	35.8	41.9	26.8	0.0	37.4	18.8	13.0
Incr Delay (d2), s/veh	3.7	0.0	1.8	0.4	6.1	2.0	8.6	16.2	0.0	2.0	4.4	0.3
Initial Q Delay(d3),s/veh	0.0	0.0	0.0	0.0	0.0	0.0	0.0	0.0	0.0	0.0	0.0	0.0
%ile BackOfQ(50%),veh/ln	3.6	0.0	5.7	1.2	7.1	4.3	3.0	19.8	0.0	4.2	13.9	1.1
LnGrp Delay(d),s/veh	31.7	0.0	35.3	30.0	43.2	37.8	50.5	43.0	0.0	39.4	23.2	13.3
LnGrp LOS	C		D	C	D	D	D	D		D	C	B
Approach Vol, veh/h		394			490			776			1039	
Approach Delay, s/veh		33.8			39.8			44.0			27.6	
Approach LOS		C			D			D			C	
Timer	1	2	3	4	5	6	7	8				
Assigned Phs	1	2	3	4	5	6	7	8				
Phs Duration (G+Y+Rc), s	11.4	50.4	7.5	25.7	18.8	43.0	11.0	22.2				
Change Period (Y+Rc), s	4.0	5.0	4.0	6.0	5.0	6.0	4.0	6.0				
Max Green Setting (Gmax), s	8.0	39.0	7.0	22.0	8.0	37.0	7.0	22.0				
Max Q Clear Time (g_c+I1), s	7.4	27.0	4.4	13.0	10.5	34.2	8.8	14.7				
Green Ext Time (p_c), s	0.0	3.2	0.0	1.6	0.0	0.8	0.0	1.4				

Intersection Summary

HCM 2010 Ctrl Delay 35.4
HCM 2010 LOS D

Notes

User approved pedestrian interval to be less than phase max green.

Timing Report, Sorted By Phase
3: Taft Hill & LCR38E/Harmony

Short Bkgrd PM
NB RT-Lane

Phase Number	1	2	3	4	5	6	7	8
Movement	NBL	SBT	WBL	EBTL	SBL	NBT	EBL	WBTL
Lead/Lag	Lead	Lag	Lead	Lag	Lag	Lead	Lead	Lag
Lead-Lag Optimize	Yes	Yes			Yes	Yes		
Recall Mode	None	C-Max	None	None	None	C-Max	None	None
Maximum Split (s)	12	44	11	28	13	43	11	28
Maximum Split (%)	12.6%	46.3%	11.6%	29.5%	13.7%	45.3%	11.6%	29.5%
Minimum Split (s)	11	23	10	25	11	26	11	28
Yellow Time (s)	3	4	3	4.5	3	4.5	3	4.5
All-Red Time (s)	1	1	1	1.5	2	1.5	1	1.5
Minimum Initial (s)	5	7	4	7	4	7	4	7
Vehicle Extension (s)	3	3	3	3	3	3	3	3
Minimum Gap (s)	3	3	3	3	3	3	3	3
Time Before Reduce (s)	0	0	0	0	0	0	0	0
Time To Reduce (s)	0	0	0	0	0	0	0	0
Walk Time (s)		7		7		7		7
Flash Dont Walk (s)		10		12		13		15
Dual Entry	Yes	Yes	No	Yes	No	Yes	No	Yes
Inhibit Max	Yes	Yes	Yes	Yes	Yes	Yes	Yes	Yes
Start Time (s)	9	21	65	76	52	9	65	76
End Time (s)	21	65	76	9	65	52	76	9
Yield/Force Off (s)	17	60	72	3	60	46	72	3
Yield/Force Off 170(s)	17	50	72	86	60	33	72	83
Local Start Time (s)	52	64	13	24	0	52	13	24
Local Yield (s)	60	8	20	46	8	89	20	46
Local Yield 170(s)	60	93	20	34	8	76	20	31

Intersection Summary

Cycle Length 95
 Control Type Actuated-Coordinated
 Natural Cycle 90
 Offset: 52 (55%), Referenced to phase 2:SBT and 6:NBT, Start of Red

Splits and Phases: 3: Taft Hill & LCR38E/Harmony

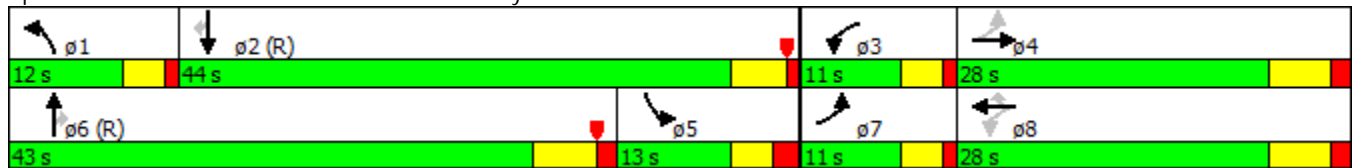























APPENDIX E

HCM 2010 Signalized Intersection Summary

3: Taft Hill & LCR38E/Harmony

Short Total AM









												
Movement	EBL	EBT	EBR	WBL	WBT	WBR	NBL	NBT	NBR	SBL	SBT	SBR
Lane Configurations												
Volume (veh/h)	214	198	66	53	52	174	41	463	57	283	536	48
Number	7	4	14	3	8	18	1	6	16	5	2	12
Initial Q (Qb), veh	0	0	0	0	0	0	0	0	0	0	0	0
Ped-Bike Adj(A_pbT)	1.00		1.00	1.00		1.00	1.00		1.00	1.00		1.00
Parking Bus, Adj	1.00	1.00	1.00	1.00	1.00	1.00	1.00	1.00	1.00	1.00	1.00	1.00
Adj Sat Flow, veh/h/ln	1863	1863	1824	1863	1863	1863	1863	1863	1824	1863	1863	1863
Adj Flow Rate, veh/h	252	233	63	62	61	0	48	545	61	333	631	0
Adj No. of Lanes	1	1	0	1	1	1	1	1	0	2	1	1
Peak Hour Factor	0.85	0.85	0.85	0.85	0.85	0.85	0.85	0.85	0.85	0.85	0.85	0.85
Percent Heavy Veh, %	2	2	2	2	2	2	2	2	2	2	2	2
Cap, veh/h	418	274	74	209	250	213	118	695	78	493	971	825
Arrive On Green	0.11	0.19	0.18	0.05	0.13	0.00	0.07	0.42	0.41	0.14	0.52	0.00
Sat Flow, veh/h	1774	1413	382	1774	1863	1583	1774	1646	184	3442	1863	1583
Grp Volume(v), veh/h	252	0	296	62	61	0	48	0	606	333	631	0
Grp Sat Flow(s),veh/h/ln	1774	0	1795	1774	1863	1583	1774	0	1830	1721	1863	1583
Q Serve(g_s), s	10.0	0.0	14.3	2.7	2.6	0.0	2.3	0.0	25.8	8.3	22.1	0.0
Cycle Q Clear(g_c), s	10.0	0.0	14.3	2.7	2.6	0.0	2.3	0.0	25.8	8.3	22.1	0.0
Prop In Lane	1.00		0.21	1.00		1.00	1.00		0.10	1.00		1.00
Lane Grp Cap(c), veh/h	418	0	348	209	250	213	118	0	773	493	971	825
V/C Ratio(X)	0.60	0.00	0.85	0.30	0.24	0.00	0.41	0.00	0.78	0.68	0.65	0.00
Avail Cap(c_a), veh/h	418	0	359	255	310	264	177	0	773	493	971	825
HCM Platoon Ratio	1.00	1.00	1.00	1.00	1.00	1.00	1.00	1.00	1.00	1.00	1.00	1.00
Upstream Filter(I)	1.00	0.00	1.00	1.00	1.00	0.00	1.00	0.00	1.00	1.00	1.00	0.00
Uniform Delay (d), s/veh	28.6	0.0	35.1	31.3	34.9	0.0	40.3	0.0	22.5	36.6	15.6	0.0
Incr Delay (d2), s/veh	2.4	0.0	17.1	0.8	0.5	0.0	2.2	0.0	7.8	3.6	3.4	0.0
Initial Q Delay(d3),s/veh	0.0	0.0	0.0	0.0	0.0	0.0	0.0	0.0	0.0	0.0	0.0	0.0
%ile BackOfQ(50%),veh/ln	1.1	0.0	8.7	1.3	1.4	0.0	1.2	0.0	14.6	4.2	12.1	0.0
LnGrp Delay(d),s/veh	31.1	0.0	52.3	32.1	35.4	0.0	42.5	0.0	30.3	40.2	19.0	0.0
LnGrp LOS	C		D	C	D		D		C	D	B	
Approach Vol, veh/h		548			123			654			964	
Approach Delay, s/veh		42.5			33.7			31.2			26.3	
Approach LOS		D			C			C			C	
Timer	1	2	3	4	5	6	7	8				
Assigned Phs	1	2	3	4	5	6	7	8				
Phs Duration (G+Y+Rc), s	9.0	50.9	7.7	22.4	16.9	43.0	13.0	17.1				
Change Period (Y+Rc), s	4.0	5.0	4.0	6.0	5.0	6.0	4.0	6.0				
Max Green Setting (Gmax), s	8.0	40.0	6.0	17.0	9.0	37.0	9.0	14.0				
Max Q Clear Time (g_c+I1), s	4.3	24.1	4.7	16.3	10.3	27.8	12.0	4.6				
Green Ext Time (p_c), s	0.0	3.3	0.0	0.1	0.0	1.6	0.0	0.8				
Intersection Summary												
HCM 2010 Ctrl Delay			32.0									
HCM 2010 LOS			C									

Notes

User approved pedestrian interval to be less than phase max green.

Timing Report, Sorted By Phase
3: Taft Hill & LCR38E/Harmony

Short Total AM

								
Phase Number	1	2	3	4	5	6	7	8
Movement	NBL	SBT	WBL	EBTL	SBL	NBT	EBL	WBTL
Lead/Lag	Lead	Lag	Lead	Lag	Lag	Lead	Lead	Lag
Lead-Lag Optimize	Yes	Yes			Yes	Yes		
Recall Mode	None	C-Max	None	None	None	Max	None	None
Maximum Split (s)	12	45	10	23	14	43	13	20
Maximum Split (%)	13.3%	50.0%	11.1%	25.6%	15.6%	47.8%	14.4%	22.2%
Minimum Split (s)	11	23	10	23	11	26	11	20
Yellow Time (s)	3	4	3	4.5	3	4.5	3	4.5
All-Red Time (s)	1	1	1	1.5	2	1.5	1	1.5
Minimum Initial (s)	5	7	4	7	4	7	4	7
Vehicle Extension (s)	3	3	3	3	3	3	3	3
Minimum Gap (s)	3	3	3	3	3	3	3	3
Time Before Reduce (s)	0	0	0	0	0	0	0	0
Time To Reduce (s)	0	0	0	0	0	0	0	0
Walk Time (s)		7		7		7		7
Flash Dont Walk (s)		10		12		13		15
Dual Entry	Yes	Yes	No	Yes	No	Yes	No	Yes
Inhibit Max	Yes	Yes	Yes	Yes	Yes	Yes	Yes	Yes
Start Time (s)	44.5	56.5	11.5	21.5	87.5	44.5	11.5	24.5
End Time (s)	56.5	11.5	21.5	44.5	11.5	87.5	24.5	44.5
Yield/Force Off (s)	52.5	6.5	17.5	38.5	6.5	81.5	20.5	38.5
Yield/Force Off 170(s)	52.5	86.5	17.5	26.5	6.5	68.5	20.5	23.5
Local Start Time (s)	33	45	0	10	76	33	0	13
Local Yield (s)	41	85	6	27	85	70	9	27
Local Yield 170(s)	41	75	6	15	85	57	9	12

Intersection Summary





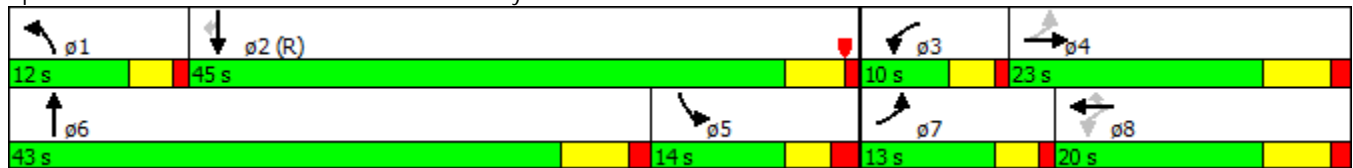

















Cycle Length 90
 Control Type Actuated-Coordinated
 Natural Cycle 80
 Offset: 11.5 (13%), Referenced to phase 2:SBT, Start of Red

Splits and Phases: 3: Taft Hill & LCR38E/Harmony



HCM 2010 Signalized Intersection Summary
 3: Taft Hill & LCR38E/Harmony

Short Total PM

												
Movement	EBL	EBT	EBR	WBL	WBT	WBR	NBL	NBT	NBR	SBL	SBT	SBR
Lane Configurations												
Volume (veh/h)	151	170	59	55	244	418	97	625	53	321	589	175
Number	7	4	14	3	8	18	1	6	16	5	2	12
Initial Q (Qb), veh	0	0	0	0	0	0	0	0	0	0	0	0
Ped-Bike Adj(A_pbT)	1.00		1.00	1.00		1.00	1.00		1.00	1.00		1.00
Parking Bus, Adj	1.00	1.00	1.00	1.00	1.00	1.00	1.00	1.00	1.00	1.00	1.00	1.00
Adj Sat Flow, veh/h/ln	1863	1863	1824	1863	1863	1863	1863	1863	1824	1863	1863	1863
Adj Flow Rate, veh/h	162	183	49	59	262	171	104	672	54	345	633	78
Adj No. of Lanes	1	1	0	1	1	1	1	1	0	2	1	1
Peak Hour Factor	0.93	0.93	0.93	0.93	0.93	0.93	0.93	0.93	0.93	0.93	0.93	0.93
Percent Heavy Veh, %	2	2	2	2	2	2	2	2	2	2	2	2
Cap, veh/h	269	307	82	276	336	286	149	663	53	574	918	781
Arrive On Green	0.08	0.22	0.21	0.05	0.18	0.18	0.08	0.39	0.38	0.17	0.49	0.49
Sat Flow, veh/h	1774	1417	379	1774	1863	1583	1774	1702	137	3442	1863	1583
Grp Volume(v), veh/h	162	0	232	59	262	171	104	0	726	345	633	78
Grp Sat Flow(s),veh/h/ln	1774	0	1796	1774	1863	1583	1774	0	1839	1721	1863	1583
Q Serve(g_s), s	6.8	0.0	11.1	2.5	12.7	9.4	5.4	0.0	37.0	8.8	24.8	2.5
Cycle Q Clear(g_c), s	6.8	0.0	11.1	2.5	12.7	9.4	5.4	0.0	37.0	8.8	24.8	2.5
Prop In Lane	1.00		0.21	1.00		1.00	1.00		0.07	1.00		1.00
Lane Grp Cap(c), veh/h	269	0	389	276	336	286	149	0	716	574	918	781
V/C Ratio(X)	0.60	0.00	0.60	0.21	0.78	0.60	0.70	0.00	1.01	0.60	0.69	0.10
Avail Cap(c_a), veh/h	269	0	435	340	451	383	149	0	716	574	918	781
HCM Platoon Ratio	1.00	1.00	1.00	1.00	1.00	1.00	1.00	1.00	1.00	1.00	1.00	1.00
Upstream Filter(I)	1.00	0.00	1.00	1.00	1.00	1.00	1.00	0.00	1.00	1.00	1.00	1.00
Uniform Delay (d), s/veh	28.0	0.0	33.6	29.5	37.1	35.8	42.3	0.0	29.0	36.7	18.5	12.8
Incr Delay (d2), s/veh	3.7	0.0	1.8	0.4	6.1	2.0	13.2	0.0	37.1	1.8	4.2	0.3
Initial Q Delay(d3),s/veh	0.0	0.0	0.0	0.0	0.0	0.0	0.0	0.0	0.0	0.0	0.0	0.0
%ile BackOfQ(50%),veh/ln	3.6	0.0	5.7	1.2	7.1	4.3	3.2	0.0	26.1	4.3	13.7	1.1
LnGrp Delay(d),s/veh	31.7	0.0	35.4	29.9	43.2	37.8	55.5	0.0	66.2	38.4	22.7	13.1
LnGrp LOS	C		D	C	D	D	E		F	D	C	B
Approach Vol, veh/h		394			492			830			1056	
Approach Delay, s/veh		33.9			39.7			64.8			27.1	
Approach LOS		C			D			E			C	
Timer	1	2	3	4	5	6	7	8				
Assigned Phs	1	2	3	4	5	6	7	8				
Phs Duration (G+Y+Rc), s	11.0	50.8	7.6	25.6	19.8	42.0	11.0	22.2				
Change Period (Y+Rc), s	4.0	5.0	4.0	6.0	5.0	6.0	4.0	6.0				
Max Green Setting (Gmax), s	7.0	40.0	7.0	22.0	9.0	36.0	7.0	22.0				
Max Q Clear Time (g_c+I1), s	7.4	26.8	4.5	13.1	10.8	39.0	8.8	14.7				
Green Ext Time (p_c), s	0.0	3.4	0.0	1.6	0.0	0.0	0.0	1.4				

Intersection Summary

HCM 2010 Ctrl Delay	41.6
HCM 2010 LOS	D

Notes

User approved pedestrian interval to be less than phase max green.

Timing Report, Sorted By Phase
3: Taft Hill & LCR38E/Harmony

Short Total PM

Phase Number	1	2	3	4	5	6	7	8
Movement	NBL	SBT	WBL	EBTL	SBL	NBT	EBL	WBTL
Lead/Lag	Lead	Lag	Lead	Lag	Lag	Lead	Lead	Lag
Lead-Lag Optimize	Yes	Yes			Yes	Yes		
Recall Mode	None	C-Max	None	None	None	C-Max	None	None
Maximum Split (s)	11	45	11	28	14	42	11	28
Maximum Split (%)	11.6%	47.4%	11.6%	29.5%	14.7%	44.2%	11.6%	29.5%
Minimum Split (s)	11	23	10	25	11	26	11	28
Yellow Time (s)	3	4	3	4.5	3	4.5	3	4.5
All-Red Time (s)	1	1	1	1.5	2	1.5	1	1.5
Minimum Initial (s)	5	7	4	7	4	7	4	7
Vehicle Extension (s)	3	3	3	3	3	3	3	3
Minimum Gap (s)	3	3	3	3	3	3	3	3
Time Before Reduce (s)	0	0	0	0	0	0	0	0
Time To Reduce (s)	0	0	0	0	0	0	0	0
Walk Time (s)		7		7		7		7
Flash Dont Walk (s)		10		12		13		15
Dual Entry	Yes	Yes	No	Yes	No	Yes	No	Yes
Inhibit Max	Yes	Yes	Yes	Yes	Yes	Yes	Yes	Yes
Start Time (s)	10	21	66	77	52	10	66	77
End Time (s)	21	66	77	10	66	52	77	10
Yield/Force Off (s)	17	61	73	4	61	46	73	4
Yield/Force Off 170(s)	17	51	73	87	61	33	73	84
Local Start Time (s)	53	64	14	25	0	53	14	25
Local Yield (s)	60	9	21	47	9	89	21	47
Local Yield 170(s)	60	94	21	35	9	76	21	32

Intersection Summary

Cycle Length 95
 Control Type Actuated-Coordinated
 Natural Cycle 90
 Offset: 52 (55%), Referenced to phase 2:SBT and 6:NBT, Start of Red



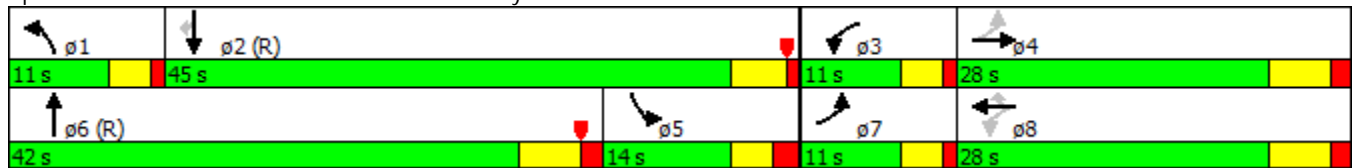



















Splits and Phases: 3: Taft Hill & LCR38E/Harmony



HCM 2010 Signalized Intersection Summary

3: Taft Hill & LCR38E/Harmony

Short Total AM
NB RT-Lane

												
Movement	EBL	EBT	EBR	WBL	WBT	WBR	NBL	NBT	NBR	SBL	SBT	SBR
Lane Configurations												
Volume (veh/h)	214	198	66	53	52	174	41	463	57	283	536	48
Number	7	4	14	3	8	18	1	6	16	5	2	12
Initial Q (Qb), veh	0	0	0	0	0	0	0	0	0	0	0	0
Ped-Bike Adj(A_pbT)	1.00		1.00	1.00		1.00	1.00		1.00	1.00		1.00
Parking Bus, Adj	1.00	1.00	1.00	1.00	1.00	1.00	1.00	1.00	1.00	1.00	1.00	1.00
Adj Sat Flow, veh/h/ln	1863	1863	1824	1863	1863	1863	1863	1863	1788	1863	1863	1863
Adj Flow Rate, veh/h	252	233	63	62	61	0	48	545	0	333	631	0
Adj No. of Lanes	1	1	0	1	1	1	1	1	1	2	1	1
Peak Hour Factor	0.85	0.85	0.85	0.85	0.85	0.85	0.85	0.85	0.85	0.85	0.85	0.85
Percent Heavy Veh, %	2	2	2	2	2	2	2	2	2	2	2	2
Cap, veh/h	418	274	74	209	250	213	118	786	625	493	971	825
Arrive On Green	0.11	0.19	0.18	0.05	0.13	0.00	0.07	0.42	0.00	0.14	0.52	0.00
Sat Flow, veh/h	1774	1413	382	1774	1863	1583	1774	1863	1520	3442	1863	1583
Grp Volume(v), veh/h	252	0	296	62	61	0	48	545	0	333	631	0
Grp Sat Flow(s),veh/h/ln	1774	0	1795	1774	1863	1583	1774	1863	1520	1721	1863	1583
Q Serve(g_s), s	10.0	0.0	14.3	2.7	2.6	0.0	2.3	21.5	0.0	8.3	22.1	0.0
Cycle Q Clear(g_c), s	10.0	0.0	14.3	2.7	2.6	0.0	2.3	21.5	0.0	8.3	22.1	0.0
Prop In Lane	1.00		0.21	1.00		1.00	1.00		1.00	1.00		1.00
Lane Grp Cap(c), veh/h	418	0	348	209	250	213	118	786	625	493	971	825
V/C Ratio(X)	0.60	0.00	0.85	0.30	0.24	0.00	0.41	0.69	0.00	0.68	0.65	0.00
Avail Cap(c_a), veh/h	418	0	359	255	310	264	177	786	625	493	971	825
HCM Platoon Ratio	1.00	1.00	1.00	1.00	1.00	1.00	1.00	1.00	1.00	1.00	1.00	1.00
Upstream Filter(I)	1.00	0.00	1.00	1.00	1.00	0.00	1.00	1.00	0.00	1.00	1.00	0.00
Uniform Delay (d), s/veh	28.6	0.0	35.1	31.3	34.9	0.0	40.3	21.2	0.0	36.6	15.6	0.0
Incr Delay (d2), s/veh	2.4	0.0	17.1	0.8	0.5	0.0	2.2	5.0	0.0	3.6	3.4	0.0
Initial Q Delay(d3),s/veh	0.0	0.0	0.0	0.0	0.0	0.0	0.0	0.0	0.0	0.0	0.0	0.0
%ile BackOfQ(50%),veh/ln	1.1	0.0	8.7	1.3	1.4	0.0	1.2	12.1	0.0	4.2	12.1	0.0
LnGrp Delay(d),s/veh	31.1	0.0	52.3	32.1	35.4	0.0	42.5	26.2	0.0	40.2	19.0	0.0
LnGrp LOS	C		D	C	D		D	C		D	B	
Approach Vol, veh/h		548			123			593			964	
Approach Delay, s/veh		42.5			33.7			27.5			26.3	
Approach LOS		D			C			C			C	
Timer	1	2	3	4	5	6	7	8				
Assigned Phs	1	2	3	4	5	6	7	8				
Phs Duration (G+Y+Rc), s	9.0	50.9	7.7	22.4	16.9	43.0	13.0	17.1				
Change Period (Y+Rc), s	4.0	5.0	4.0	6.0	5.0	6.0	4.0	6.0				
Max Green Setting (Gmax), s	8.0	40.0	6.0	17.0	9.0	37.0	9.0	14.0				
Max Q Clear Time (g_c+I1), s	4.3	24.1	4.7	16.3	10.3	23.5	12.0	4.6				
Green Ext Time (p_c), s	0.0	3.3	0.0	0.1	0.0	1.6	0.0	0.8				

Intersection Summary









HCM 2010 Ctrl Delay	31.0
HCM 2010 LOS	C

Notes

User approved pedestrian interval to be less than phase max green.

Timing Report, Sorted By Phase
3: Taft Hill & LCR38E/Harmony

Short Total AM
NB RT-Lane

								
Phase Number	1	2	3	4	5	6	7	8
Movement	NBL	SBT	WBL	EBTL	SBL	NBT	EBL	WBTL
Lead/Lag	Lead	Lag	Lead	Lag	Lag	Lead	Lead	Lag
Lead-Lag Optimize	Yes	Yes			Yes	Yes		
Recall Mode	None	C-Max	None	None	None	Max	None	None
Maximum Split (s)	12	45	10	23	14	43	13	20
Maximum Split (%)	13.3%	50.0%	11.1%	25.6%	15.6%	47.8%	14.4%	22.2%
Minimum Split (s)	11	23	10	23	11	26	11	20
Yellow Time (s)	3	4	3	4.5	3	4.5	3	4.5
All-Red Time (s)	1	1	1	1.5	2	1.5	1	1.5
Minimum Initial (s)	5	7	4	7	4	7	4	7
Vehicle Extension (s)	3	3	3	3	3	3	3	3
Minimum Gap (s)	3	3	3	3	3	3	3	3
Time Before Reduce (s)	0	0	0	0	0	0	0	0
Time To Reduce (s)	0	0	0	0	0	0	0	0
Walk Time (s)		7		7		7		7
Flash Dont Walk (s)		10		12		13		15
Dual Entry	Yes	Yes	No	Yes	No	Yes	No	Yes
Inhibit Max	Yes	Yes	Yes	Yes	Yes	Yes	Yes	Yes
Start Time (s)	44.5	56.5	11.5	21.5	87.5	44.5	11.5	24.5
End Time (s)	56.5	11.5	21.5	44.5	11.5	87.5	24.5	44.5
Yield/Force Off (s)	52.5	6.5	17.5	38.5	6.5	81.5	20.5	38.5
Yield/Force Off 170(s)	52.5	86.5	17.5	26.5	6.5	68.5	20.5	23.5
Local Start Time (s)	33	45	0	10	76	33	0	13
Local Yield (s)	41	85	6	27	85	70	9	27
Local Yield 170(s)	41	75	6	15	85	57	9	12

Intersection Summary

Cycle Length 90
 Control Type Actuated-Coordinated
 Natural Cycle 75
 Offset: 11.5 (13%), Referenced to phase 2:SBT, Start of Red



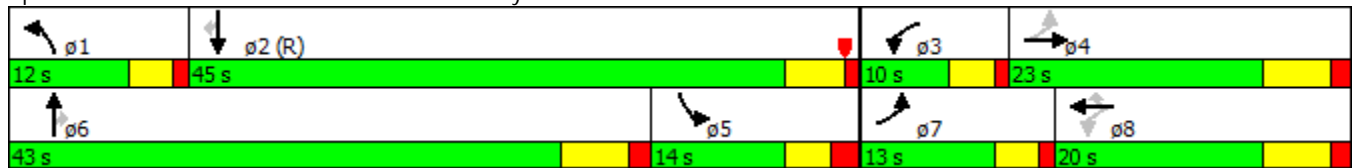



















Splits and Phases: 3: Taft Hill & LCR38E/Harmony



HCM 2010 Signalized Intersection Summary

3: Taft Hill & LCR38E/Harmony

Short Total PM
NB RT-Lane

												
Movement	EBL	EBT	EBR	WBL	WBT	WBR	NBL	NBT	NBR	SBL	SBT	SBR
Lane Configurations												
Volume (veh/h)	151	170	59	55	244	418	97	625	53	321	589	175
Number	7	4	14	3	8	18	1	6	16	5	2	12
Initial Q (Qb), veh	0	0	0	0	0	0	0	0	0	0	0	0
Ped-Bike Adj(A_pbT)	1.00		1.00	1.00		1.00	1.00		1.00	1.00		1.00
Parking Bus, Adj	1.00	1.00	1.00	1.00	1.00	1.00	1.00	1.00	1.00	1.00	1.00	1.00
Adj Sat Flow, veh/h/ln	1863	1863	1824	1863	1863	1863	1863	1863	1788	1863	1863	1863
Adj Flow Rate, veh/h	162	183	49	59	262	183	104	672	0	345	633	77
Adj No. of Lanes	1	1	0	1	1	1	1	1	1	2	1	1
Peak Hour Factor	0.93	0.93	0.93	0.93	0.93	0.93	0.93	0.93	0.93	0.93	0.93	0.93
Percent Heavy Veh, %	2	2	2	2	2	2	2	2	2	2	2	2
Cap, veh/h	269	307	82	276	337	286	157	745	608	537	910	773
Arrive On Green	0.08	0.22	0.21	0.05	0.18	0.18	0.09	0.40	0.00	0.16	0.49	0.49
Sat Flow, veh/h	1774	1417	379	1774	1863	1583	1774	1863	1520	3442	1863	1583
Grp Volume(v), veh/h	162	0	232	59	262	183	104	672	0	345	633	77
Grp Sat Flow(s),veh/h/ln	1774	0	1796	1774	1863	1583	1774	1863	1520	1721	1863	1583
Q Serve(g_s), s	6.8	0.0	11.1	2.5	12.7	10.2	5.4	32.2	0.0	8.9	25.0	2.5
Cycle Q Clear(g_c), s	6.8	0.0	11.1	2.5	12.7	10.2	5.4	32.2	0.0	8.9	25.0	2.5
Prop In Lane	1.00		0.21	1.00		1.00	1.00		1.00	1.00		1.00
Lane Grp Cap(c), veh/h	269	0	389	276	337	286	157	745	608	537	910	773
V/C Ratio(X)	0.60	0.00	0.60	0.21	0.78	0.64	0.66	0.90	0.00	0.64	0.70	0.10
Avail Cap(c_a), veh/h	269	0	435	340	451	383	168	745	608	537	910	773
HCM Platoon Ratio	1.00	1.00	1.00	1.00	1.00	1.00	1.00	1.00	1.00	1.00	1.00	1.00
Upstream Filter(I)	1.00	0.00	1.00	1.00	1.00	1.00	1.00	1.00	0.00	1.00	1.00	1.00
Uniform Delay (d), s/veh	28.0	0.0	33.6	29.5	37.1	36.0	41.9	26.8	0.0	37.6	18.8	13.1
Incr Delay (d2), s/veh	3.7	0.0	1.8	0.4	6.0	2.4	8.6	16.2	0.0	2.6	4.4	0.3
Initial Q Delay(d3),s/veh	0.0	0.0	0.0	0.0	0.0	0.0	0.0	0.0	0.0	0.0	0.0	0.0
%ile BackOfQ(50%),veh/ln	3.6	0.0	5.7	1.2	7.1	4.7	3.0	19.8	0.0	4.5	13.9	1.1
LnGrp Delay(d),s/veh	31.7	0.0	35.4	29.9	43.1	38.4	50.5	43.0	0.0	40.2	23.2	13.3
LnGrp LOS	C		D	C	D	D	D	D		D	C	B
Approach Vol, veh/h		394			504			776			1055	
Approach Delay, s/veh		33.9			39.9			44.0			28.1	
Approach LOS		C			D			D			C	
Timer	1	2	3	4	5	6	7	8				
Assigned Phs	1	2	3	4	5	6	7	8				
Phs Duration (G+Y+Rc), s	11.4	50.4	7.6	25.6	18.8	43.0	11.0	22.2				
Change Period (Y+Rc), s	4.0	5.0	4.0	6.0	5.0	6.0	4.0	6.0				
Max Green Setting (Gmax), s	8.0	39.0	7.0	22.0	8.0	37.0	7.0	22.0				
Max Q Clear Time (g_c+I1), s	7.4	27.0	4.5	13.1	10.9	34.2	8.8	14.7				
Green Ext Time (p_c), s	0.0	3.3	0.0	1.6	0.0	0.8	0.0	1.5				

Intersection Summary

HCM 2010 Ctrl Delay 35.6
HCM 2010 LOS D

Notes

User approved pedestrian interval to be less than phase max green.

Timing Report, Sorted By Phase
3: Taft Hill & LCR38E/Harmony

Short Total PM
NB RT-Lane

Phase Number	1	2	3	4	5	6	7	8
Movement	NBL	SBT	WBL	EBTL	SBL	NBT	EBL	WBTL
Lead/Lag	Lead	Lag	Lead	Lag	Lag	Lead	Lead	Lag
Lead-Lag Optimize	Yes	Yes			Yes	Yes		
Recall Mode	None	C-Max	None	None	None	C-Max	None	None
Maximum Split (s)	12	44	11	28	13	43	11	28
Maximum Split (%)	12.6%	46.3%	11.6%	29.5%	13.7%	45.3%	11.6%	29.5%
Minimum Split (s)	11	23	10	25	11	26	11	28
Yellow Time (s)	3	4	3	4.5	3	4.5	3	4.5
All-Red Time (s)	1	1	1	1.5	2	1.5	1	1.5
Minimum Initial (s)	5	7	4	7	4	7	4	7
Vehicle Extension (s)	3	3	3	3	3	3	3	3
Minimum Gap (s)	3	3	3	3	3	3	3	3
Time Before Reduce (s)	0	0	0	0	0	0	0	0
Time To Reduce (s)	0	0	0	0	0	0	0	0
Walk Time (s)		7		7		7		7
Flash Dont Walk (s)		10		12		13		15
Dual Entry	Yes	Yes	No	Yes	No	Yes	No	Yes
Inhibit Max	Yes	Yes	Yes	Yes	Yes	Yes	Yes	Yes
Start Time (s)	9	21	65	76	52	9	65	76
End Time (s)	21	65	76	9	65	52	76	9
Yield/Force Off (s)	17	60	72	3	60	46	72	3
Yield/Force Off 170(s)	17	50	72	86	60	33	72	83
Local Start Time (s)	52	64	13	24	0	52	13	24
Local Yield (s)	60	8	20	46	8	89	20	46
Local Yield 170(s)	60	93	20	34	8	76	20	31

Intersection Summary

Cycle Length 95
 Control Type Actuated-Coordinated
 Natural Cycle 90
 Offset: 52 (55%), Referenced to phase 2:SBT and 6:NBT, Start of Red

Splits and Phases: 3: Taft Hill & LCR38E/Harmony

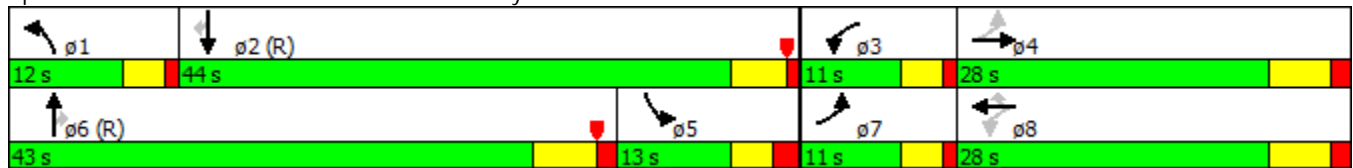

Intersection

Int Delay, s/veh 0.6

Movement	EBT	EBR	WBL	WBT	NBL	NBR
Vol, veh/h	532	6	5	262	17	15
Conflicting Peds, #/hr	0	0	0	0	0	0
Sign Control	Free	Free	Free	Free	Stop	Stop
RT Channelized	-	None	-	None	-	None
Storage Length	-	-	200	-	0	-
Veh in Median Storage, #	0	-	-	0	0	-
Grade, %	0	-	-	0	0	-
Peak Hour Factor	85	85	85	85	85	85
Heavy Vehicles, %	2	2	2	2	2	2
Mvmt Flow	626	7	6	308	20	18











Major/Minor	Major1	Major2	Minor1
Conflicting Flow All	0	0	633
Stage 1	-	-	-
Stage 2	-	-	-
Critical Hdwy	-	-	4.14
Critical Hdwy Stg 1	-	-	-
Critical Hdwy Stg 2	-	-	-
Follow-up Hdwy	-	-	2.22
Pot Cap-1 Maneuver	-	-	946
Stage 1	-	-	-
Stage 2	-	-	-
Platoon blocked, %	-	-	-
Mov Cap-1 Maneuver	-	-	946
Mov Cap-2 Maneuver	-	-	-
Stage 1	-	-	-
Stage 2	-	-	-

Approach	EB	WB	NB
HCM Control Delay, s	0	0.2	14.2
HCM LOS			B

Minor Lane/Major Mvmt	NBLn1	EBT	EBR	WBL	WBT
Capacity (veh/h)	428	-	-	946	-
HCM Lane V/C Ratio	0.088	-	-	0.006	-
HCM Control Delay (s)	14.2	-	-	8.8	-
HCM Lane LOS	B	-	-	A	-
HCM 95th %tile Q(veh)	0.3	-	-	0	-

Lanes and Geometrics
5: Site Access & Harmony

Short Total AM

						
Lane Group	EBT	EBR	WBL	WBT	NBL	NBR
Lane Configurations						
Ideal Flow (vphp)	1900	1900	1900	1900	1900	1900
Lane Width (ft)	12	12	12	12	12	12
Grade (%)	0%			0%	0%	
Storage Length (ft)		0	200		0	0
Storage Lanes		0	1		1	0
Taper Length (ft)			25		25	
Lane Util. Factor	0.95	0.95	1.00	0.95	1.00	1.00
Ped Bike Factor						
Frt	0.998				0.936	
Flt Protected			0.950		0.974	
Satd. Flow (prot)	3532	0	1770	3539	1698	0
Flt Permitted			0.950		0.974	
Satd. Flow (perm)	3532	0	1770	3539	1698	0
Link Speed (mph)	30			30	30	
Link Distance (ft)	541			402	166	
Travel Time (s)	12.3			9.1	3.8	
Intersection Summary						
Area Type:	Other					

Intersection

Int Delay, s/veh 0.4

Movement	EBT	EBR	WBL	WBT	NBL	NBR
Vol, veh/h	526	18	16	706	11	9
Conflicting Peds, #/hr	0	0	0	0	0	0
Sign Control	Free	Free	Free	Free	Stop	Stop
RT Channelized	-	None	-	None	-	None
Storage Length	-	-	200	-	0	-
Veh in Median Storage, #	0	-	-	0	0	-
Grade, %	0	-	-	0	0	-
Peak Hour Factor	90	90	90	90	90	90
Heavy Vehicles, %	2	2	2	2	2	2
Mvmt Flow	584	20	18	784	12	10











Major/Minor	Major1	Major2	Minor1
Conflicting Flow All	0	0	604
Stage 1	-	-	-
Stage 2	-	-	-
Critical Hdwy	-	-	4.14
Critical Hdwy Stg 1	-	-	-
Critical Hdwy Stg 2	-	-	-
Follow-up Hdwy	-	-	2.22
Pot Cap-1 Maneuver	-	-	970
Stage 1	-	-	-
Stage 2	-	-	-
Platoon blocked, %	-	-	-
Mov Cap-1 Maneuver	-	-	970
Mov Cap-2 Maneuver	-	-	-
Stage 1	-	-	-
Stage 2	-	-	-

Approach	EB	WB	NB
HCM Control Delay, s	0	0.2	16.8
HCM LOS			C

Minor Lane/Major Mvmt	NBLn1	EBT	EBR	WBL	WBT
Capacity (veh/h)	327	-	-	970	-
HCM Lane V/C Ratio	0.068	-	-	0.018	-
HCM Control Delay (s)	16.8	-	-	8.8	-
HCM Lane LOS	C	-	-	A	-
HCM 95th %tile Q(veh)	0.2	-	-	0.1	-

Lanes and Geometrics
 5: Site Access & Harmony

Short Total PM

						
Lane Group	EBT	EBR	WBL	WBT	NBL	NBR
Lane Configurations						
Ideal Flow (vphp)	1900	1900	1900	1900	1900	1900
Lane Width (ft)	12	12	12	12	12	12
Grade (%)	0%			0%	0%	
Storage Length (ft)		0	200		0	0
Storage Lanes		0	1		1	0
Taper Length (ft)			25		25	
Lane Util. Factor	0.95	0.95	1.00	0.95	1.00	1.00
Ped Bike Factor						
Frt	0.995				0.939	
Flt Protected			0.950		0.973	
Satd. Flow (prot)	3522	0	1770	3539	1702	0
Flt Permitted			0.950		0.973	
Satd. Flow (perm)	3522	0	1770	3539	1702	0
Link Speed (mph)	30			30	30	
Link Distance (ft)	541			402	166	
Travel Time (s)	12.3			9.1	3.8	
Intersection Summary						
Area Type:	Other					

APPENDIX F



SCALE: 1"=500'

PEDESTRIAN INFLUENCE AREA

Pedestrian LOS Worksheet

Project Location Classification: All Other Areas

	Description of Applicable Destination Area Within 1320'	Destination Area Classification	Level of Service (minimum based on project location classification)					
			Directness	Continuity	Street Crossings	Visual Interest & Amenities	Security	
1	Commercial uses to the northwest of the site	Commercial	Minimum	C	C	C	C	C
			Actual	A	B	B	C	B
			Proposed	A	B	B	C	B
2	Neighborhood to the north of the site	Residential	Minimum	C	C	C	C	C
			Actual	A	D	B	C	C
			Proposed	A	D	B	C	C
3	Neighborhood to the south and southeast of the site	Residential	Minimum	C	C	C	C	C
			Actual	A	B	B	B	B
			Proposed	A	B	B	B	B
4	Neighborhood to the southwest of the site	Residential	Minimum	C	C	C	C	C
			Actual	B	D	B	C	C
			Proposed	B	D	B	C	C
5			Minimum					
			Actual					
			Proposed					
6			Minimum					
			Actual					
			Proposed					
7			Minimum					
			Actual					
			Proposed					
8			Minimum					
			Actual					
			Proposed					
9			Minimum					
			Actual					
			Proposed					
10			Minimum					
			Actual					
			Proposed					

November 30, 2015



Habitat for Humanity
c/o JB Consulting Services
1619 Streamside Drive
Fort Collins, Colorado 80525

Attn: Mr. John Barberio (johnb@jbconsultingservices.com)

Re: Geotechnical Exploration Report
Habitat for Humanity
West Harmony Road and South Taft Hill Road
Fort Collins, Colorado
EEC Project No. 1152114

Mr. Barberio:

Earth Engineering Consultants, LLC (EEC) personnel have completed the supplemental geotechnical exploration for the proposed Habitat for Humanity project at the southeast corner of West Harmony Road and South Taft Hill Road in Fort Collins. A geotechnical exploration on this property was completed by others in 2005. The supplemental exploration was completed to help evaluate current conditions at the site to provide updated recommendations considering current site conditions and current codes and standards. The subsurface exploration completed as a part of the 2005 exploration on this property was evaluated and considered when developing the recommendations contained in this report.

We understand this project involves development of approximately 21 duplex buildings on the referenced parcel for Habitat for Humanity. The new buildings are expected to be single story or two-story wood-framed structures, a portion of which may include basements. We anticipate maximum wall and column loads be on the order of 2½ kips per lineal foot and 50 kips, respectively. Small grade changes are expected to develop the site grades. On-site paved drive and parking areas will be constructed as a part of this project. The site layout for the proposed development is indicated on the attached boring location diagram.

As a part of the 2005 geotechnical exploration, nine (9) soil borings were completed on this property extending to depths ranging from approximately 10 to 25 feet below current site grades. To develop supplemental, current geotechnical data, four (4) additional borings were advanced to depths of approximately 15 feet below present site grades. The locations of the previously

completed and currently completed exploration borings are indicated on the attached boring location diagram. The locations of those borings should be considered accurate only to the degree implied by the methods used to make the field measurements.

To develop additional information on groundwater levels, field slotted PVC piezometers were installed at the four (4) boring locations completed as a part of the current exploration. Those temporary piezometers were monitored for an approximate 2-week period after installation. Results of the field monitoring are indicated on the upper right hand corner of the boring logs.

Moisture content tests and visual/tactual evaluation of recovered samples was completed in the laboratory as a part of the geotechnical evaluation. Dry density tests were completed on selected samples and the unconfined strength of appropriate samples was estimated using a calibrated hand penetrometer. Swell/consolidation tests were completed on selected samples to evaluate the soils' tendency to change volume with variation in moisture content and load. Results of the outlined tests are indicated on the attached boring logs and summary sheets.

Based on results of the field borings and laboratory testing, subsurface conditions can be generalized as follows. Sparse vegetation and/or topsoil was observed at ground surface at the boring locations. The vegetation/topsoil in borings P-1, P-2 and P-3 were underlain by brown to reddish brown sandy lean clay. The sandy lean clay in boring P-3 transitioned to clayey sand at a depth of approximately 4 feet and in boring P-2 to sands and gravels at a depth of approximately 12 feet. Sand and gravel was encountered beneath the vegetation/topsoil in boring P-4 extending to a depth of approximately 10 feet. Claystone, siltstone bedrock was encountered beneath the overburden soils in borings P-1, P-3 and P-4 at depths ranging from approximately 9½ to 14½ feet. The overburden lean clay soils showed low to moderate plasticity and low to moderate swell potential with the underlying claystone, siltstone bedrock exhibiting high plasticity and high swell. Test borings were terminated at depths of approximately 15 feet below present site grades in claystone bedrock (borings P-1, P-3 and P4) or sands and gravel (boring P-2).

Groundwater observations were completed at the time of drilling and in the field slotted PVC piezometers for approximately 2 weeks after installation. No free water was observed in the test borings at the time of completion or in the field piezometers during the monitoring period.

Zones of perched and/or trapped water may be encountered at times throughout the year in more permeable zones in the subgrade soils. Perched groundwater is commonly encountered in soils overlying less permeable weathered bedrock. Fluctuations in the location and amount of perched water can also vary over time depending on variations in hydrologic conditions and other conditions not apparent at the time of this report.

ANALYSIS AND RECOMMENDATIONS

General Observations

The near surface cohesive soils show low to moderate plasticity and low to moderate swell potential at current moisture and density conditions. Those conditions are somewhat variable across the site. To reduce the potential for post-construction heaving of site improvements, moderately expansive soils in building and pavement areas should be removed, moisture conditioned and replaced as controlled fill. The depth of the overexcavations could vary across the site depending on the expansion potential of the subgrade soils and on acceptable movement in floor slabs and pavement areas.

The underlying claystone bedrock also shows moderate to high swell potential and moderate to high plasticity. As such, care should be taken to maintain separation from the bedrock for any below grade areas to reduce potential for post-construction heaving of foundations and/or floor slabs. In general, a separation of 4 feet from the bedrock surface should be maintained for footings and floor slabs.

Site Preparation

All existing vegetation and/or topsoil should be removed from site improvement areas. In addition, any moderately expansive cohesive soils should also be removed. The site cohesive soils could be reused as fill in the improvement areas although care will be necessary to see that acceptable moisture contents are maintained in the subgrade soils prior to completion of the overlying improvements to maintain low swell potential for foundation, floor slab and pavement support.

After stripping and removing all moderately expansive materials and prior to placement of any fill, floor slab or pavements, we recommend the in-place soils be scarified to a minimum depth of 9 inches, adjusted in moisture content and compacted to at least 95% of the material's standard Proctor maximum dry density as determined in accordance ASTM Specification D698. The moisture content of the scarified material should be adjusted to within the range of $\pm 2\%$ of standard Proctor optimum moisture at the time of compaction.

Fill soils required to develop the site subgrades should consist of approved, low volume change materials which are free from organic matter and debris. We believe the site materials could be used for general site fill although care will be necessary to maintain the moisture in the subgrade soils to reduce potential for post-construction movement/heaving of the overlying improvements. Site cohesive materials should be placed in loose lifts not to exceed 9 inches thick, adjusted in moisture content as recommended for the scarified soils and compacted to be at least 95% of standard Proctor maximum dry density.

Care should be taken after placement of fill materials to avoid disturbing the in-place materials and to prevent wetting and drying of those materials. Soils which are disturbed by the construction activities or materials which become wet and unstable or dry and desiccated should be removed and replaced or reworked in place prior to placement of the overlying improvements.

Foundations

Based on materials observed at the boring locations, in our opinion, the site structures could be supported on conventional footing foundations bearing in the natural stiff to very stiff sandy lean clay soils or medium dense granular soils. For design of footing foundations bearing on suitable stiff to very stiff low volume change natural lean clays or medium dense granular to essentially granular soils, we recommend using a net allowable total load soil bearing pressure not to exceed 1,500 psf. The net bearing pressure refers to the pressure at foundation bearing level in excess of the minimum surrounding overburden pressure. A minimum dead load pressure would not be required in the low volume change cohesive soils or essentially non-volume change granular soils.

Exterior foundations and foundations in unheated areas should be located at least 30 inches below adjacent exterior grades to provide frost protection. Footing foundations should maintain a separation of at least 4 feet from the underlying claystone bedrock. We recommend formed continuous footings have a minimum width of 16 inches and isolated column foundations have a minimum width of 30 inches.

Care should be taken at the time of construction to see that footing foundations are supported on suitable strength natural soils. Soils which are loosened or disturbed by the construction activities or materials which become dry and desiccated or wet and softened should be removed and replaced with acceptable backfill soils prior to construction of the footing foundations.

We estimate the long-term settlement of footing foundations designed and constructed as outlined above would be less than 1 inch.

Floor Slabs

Floor slab subgrades should be prepared as outlined above for site preparation. Care should be taken after preparation of the floor slab subgrades to prevent wetting or drying of the prepared materials. Cohesive subgrade soils which are allowed to become dry and desiccated can result in increased swell potential and heaving of floor slabs supported on those materials. Care should also be taken to avoid disturbing the in-place subgrade materials and to prevent wetting or drying of the subgrades.

Below Grade Areas

We recommend a perimeter drain system be installed around all below grade areas to intercept surface infiltration and prevent surface infiltration water from entering the below grade areas. In general a perimeter drain system would consist of perforated metal or plastic pipe placed around the exterior perimeter of the below grade area and sloped to drain to a sump area where it can be removed without reverse flow into the system. The drain line should be surrounded by an appropriate/granular filter material to prevent fines from entering the system.

Below grade walls would be subject to lateral earth pressures. We recommend using an at-rest lateral earth pressure for design of the below grade walls which are restrained from movement. For backfill soils consisting of the site cohesive materials, we recommend using an equivalent fluid pressure of 60 pounds pcf assuming positive drainage to prevent development of hydrostatic loads on below grade walls. Surcharge loads, point loads, or hydrostatic loads would be an addition to the recommended equivalent fluid pressure. The outlined equivalent fluid pressure does not include a factor of safety nor an allowance for hydrostatic loads.

Seismic

The site subgrades are variable with layered cohesive and granular soils overlying claystone bedrock. The depth to the bedrock is variable. Based on the 2012 International Building Code, we recommend a Site Classification of D be used for seismic design.

Site Pavements

We anticipate site pavements be private paved drives with low volumes of predominately light traffic. However, some truck traffic, including weekly trash pick-up would be anticipated to utilize the site pavements.

Subgrades for the pavements should be prepared as outlined in the *Site Preparation* section of this report. Cohesive subgrade soils at elevated moisture contents can result in instability/pumping of the subgrades. If instability is noted in the pavement subgrades at the time of paving, consideration could be given to stabilizing the subgrades with the addition of Class C fly ash. Structural credit for a fly ash subgrade could be considered in design of the pavement sections, although with the minimum pavement design proposed, the use of a stabilized subgrade would not reduce the overlying pavement sections.

We recommend pavement sections consist of at least 4 inches of hot bituminous pavement (HBP) overlying 6 inches of aggregate base coarse (ABC). As an alternative, a section of 5½ inches Portland cement concrete could also be used. In the turnaround area at the west end of the site, thicker pavement sections would be appropriate and we suggest consideration be given to

Portland cement concrete in this area to help resist degradation from any trash truck traffic. Pavements should be designed in accordance with Larimer County Urban Area Street Standards.

Other Considerations

Positive drainage should be developed across and away from the pavements and away from the residences to prevent wetting of the subgrade and varying materials. If subgrade of varying materials become wetted subsequent to construction, it can result in premature failure of the overlying improvements. We recommend at least 1 inch per foot for the first 10 feet away from the structures in landscape areas although flatter slopes with positive drainage could be used in hardscape areas.

GENERAL COMMENTS

The analysis and recommendations presented in this report are based upon the data obtained from the soil borings performed at the indicated locations and from any other information discussed in this report. This report does not reflect any variations, which may occur between borings or across the site. The nature and extent of such variations may not become evident until construction. If variations appear evident, it will be necessary to re-evaluate the recommendations of this report.

It is recommended that the geotechnical engineer be retained to review the plans and specifications so comments can be made regarding the interpretation and implementation of our geotechnical recommendations in the design and specifications. It is further recommended that the geotechnical engineer be retained for testing and observations during earthwork phases to help determine that the design requirements are fulfilled.

This report has been prepared for the exclusive use of Habitat for Humanity c/o JB Consulting Services for specific application to the project discussed and has been prepared in accordance with generally accepted geotechnical engineering practices. No warranty, expressed or implied, is made. In the event that any changes in the nature, design, or location of the project as outlined in this report are planned, the conclusions and recommendations contained in this report shall not

Habitat for Humanity
November 30, 2015
Page 8

be considered valid unless the changes are reviewed and the conclusions of this report are modified or verified in writing by the geotechnical engineer.

We appreciate the opportunity to be of service to you on this project. If you have any questions concerning this report, or if we can be of further service to you in any other way, please do not hesitate to contact us.

Very truly yours,
Earth Engineering Consultants, LLC



Ethan P. Wiechert, P.E.
Senior Project Engineer

Reviewed by: Lester L. Litton, P.E.
Principal Engineer

DRILLING AND EXPLORATION

DRILLING & SAMPLING SYMBOLS:

SS: Split Spoon - 13/8" I.D., 2" O.D., unless otherwise noted
 ST: Thin-Walled Tube - 2" O.D., unless otherwise noted
 R: Ring Barrel Sampler - 2.42" I.D., 3" O.D. unless otherwise noted
 PA: Power Auger
 HA: Hand Auger
 DB: Diamond Bit = 4", N, B
 AS: Auger Sample
 HS: Hollow Stem Auger

PS: Piston Sample
 WS: Wash Sample
 FT: Fish Tail Bit
 RB: Rock Bit
 BS: Bulk Sample
 PM: Pressure Meter
 WB: Wash Bore

Standard "N" Penetration: Blows per foot of a 140 pound hammer falling 30 inches on a 2-inch O.D. split spoon, except where noted.

WATER LEVEL MEASUREMENT SYMBOLS:

WL : Water Level
 WCI: Wet Cave in
 DCI: Dry Cave in
 AB : After Boring

WS : While Sampling
 WD : While Drilling
 BCR: Before Casing Removal
 ACR: After Casting Removal

Water levels indicated on the boring logs are the levels measured in the borings at the time indicated. In pervious soils, the indicated levels may reflect the location of ground water. In low permeability soils, the accurate determination of ground water levels is not possible with only short term observations.

DESCRIPTIVE SOIL CLASSIFICATION

Soil Classification is based on the Unified Soil Classification system and the ASTM Designations D-2488. Coarse Grained Soils have more than 50% of their dry weight retained on a #200 sieve; they are described as: boulders, cobbles, gravel or sand. Fine Grained Soils have less than 50% of their dry weight retained on a #200 sieve; they are described as: clays, if they are plastic, and silts if they are slightly plastic or non-plastic. Major constituents may be added as modifiers and minor constituents may be added according to the relative proportions based on grain size. In addition to gradation, coarse grained soils are defined on the basis of their in-place density and fine grained soils on the basis of their consistency. Example: Lean clay with sand, trace gravel, stiff (CL); silty sand, trace gravel, medium dense (SM).

CONSISTENCY OF FINE-GRAINED SOILS

Unconfined Compressive Strength, Qu, psf	Consistency
< 500	Very Soft
500 - 1,000	Soft
1,001 - 2,000	Medium
2,001 - 4,000	Stiff
4,001 - 8,000	Very Stiff
8,001 - 16,000	Very Hard

RELATIVE DENSITY OF COARSE-GRAINED SOILS:

N-Blows/ft	Relative Density
0-3	Very Loose
4-9	Loose
10-29	Medium Dense
30-49	Dense
50-80	Very Dense
80 +	Extremely Dense

PHYSICAL PROPERTIES OF BEDROCK

DEGREE OF WEATHERING:

Slight	Slight decomposition of parent material on joints. May be color change.
Moderate	Some decomposition and color change throughout.
High	Rock highly decomposed, may be extremely broken.

HARDNESS AND DEGREE OF CEMENTATION:

Limestone and Dolomite:

Hard	Difficult to scratch with knife.
Moderately	Can be scratched easily with knife.
Hard	Cannot be scratched with fingernail.
Soft	Can be scratched with fingernail.

Shale, Siltstone and Claystone:

Hard	Can be scratched easily with knife, cannot be scratched with fingernail.
Moderately	Can be scratched with fingernail.
Hard	
Soft	Can be easily dented but not molded with fingers.

Sandstone and Conglomerate:

Well Cemented	Capable of scratching a knife blade.
Cemented	
Cemented	Can be scratched with knife.
Poorly Cemented	Can be broken apart easily with fingers.



UNIFIED SOIL CLASSIFICATION SYSTEM

Criteria for Assigning Group Symbols and Group Names Using Laboratory Tests				Soil Classification		
				Group Symbol	Group Name	
Coarse - Grained Soils more than 50% retained on No. 200 sieve	Gravels more than 50% of coarse fraction retained on No. 4 sieve	Clean Gravels Less than 5% fines	$Cu \geq 4$ and $1 < Cc \leq 3^E$	GW	Well-graded gravel ^F	
			$Cu < 4$ and/or $1 > Cc > 3^E$	GP	Poorly-graded gravel ^F	
		Gravels with Fines more than 12% fines	Fines classify as ML or MH	GM	Silty gravel ^{G,H}	
	Fines Classify as CL or CH		GC	Clayey Gravel ^{F,G,H}		
	Sands 50% or more coarse fraction passes No. 4 sieve	Clean Sands Less than 5% fines	$Cu \geq 6$ and $1 < Cc \leq 3^E$	SW	Well-graded sand ^I	
			$Cu < 6$ and/or $1 > Cc > 3^E$	SP	Poorly-graded sand ^I	
Sands with Fines more than 12% fines		Fines classify as ML or MH	SM	Silty sand ^{G,H,I}		
		Fines classify as CL or CH	SC	Clayey sand ^{G,H,I}		
Fine-Grained Soils 50% or more passes the No. 200 sieve	Silt and Clays Liquid Limit less than 50	inorganic	$PI > 7$ and plots on or above "A" Line	CL	Lean clay ^{K,L,M}	
			$PI < 4$ or plots below "A" Line	ML	Silt ^{K,L,M}	
		organic	Liquid Limit - oven dried < 0.75	OL	Organic silt ^{K,L,M,O}	
			Liquid Limit - not dried	OH	Organic clay ^{K,L,M,P}	
	Silt and Clays Liquid Limit 50 or more	inorganic	PI plots on or above "A" Line	CH	Fat clay ^{K,L,M}	
			PI plots below "A" Line	MH	Elastic Silt ^{K,L,M}	
		organic	Liquid Limit - oven dried < 0.75	OH	Organic clay ^{K,L,M,P}	
			Liquid Limit - not dried	OL	Organic silt ^{K,L,M,O}	
			Primarily organic matter, dark in color, and organic odor		PT	Peat

^ABased on the material passing the 3-in. (75-mm) sieve

^BIf field sample contained cobbles or boulders, or both, add "with cobbles or boulders, or both" to group name.

^CGravels with 5 to 12% fines required dual symbols:
 GW-GM well graded gravel with silt
 GW-GC well-graded gravel with clay
 GP-GM poorly-graded gravel with silt
 GP-GC poorly-graded gravel with clay

^DSands with 5 to 12% fines require dual symbols:
 SW-SM well-graded sand with silt
 SW-SC well-graded sand with clay
 SP-SM poorly graded sand with silt
 SP-SC poorly graded sand with clay

$Cu = D_{60}/D_{10}$ $Cc = \frac{(D_{30})^2}{D_{10} \times D_{60}}$

^EIf soil contains $\geq 15\%$ sand, add "with sand" to group name

^FIf fines classify as CL-ML, use dual symbol GC-CM, or SC-SM.

^GIf fines are organic, add "with organic fines" to group name

^HIf soil contains $> 15\%$ gravel, add "with gravel" to group name

^IIf Atterberg limits plots shaded area, soil is a CL-ML, Silty clay

^KIf soil contains 15 to 29% plus No. 200, add "with sand" or "with gravel", whichever is predominant.

^LIf soil contains $\geq 30\%$ plus No. 200 predominantly sand, add "sandy" to group name.

^MIf soil contains $\geq 30\%$ plus No. 200 predominantly gravel, add "gravelly" to group name.

^N $PI \geq 4$ and plots on or above "A" line.

^O $PI \leq 4$ or plots below "A" line.

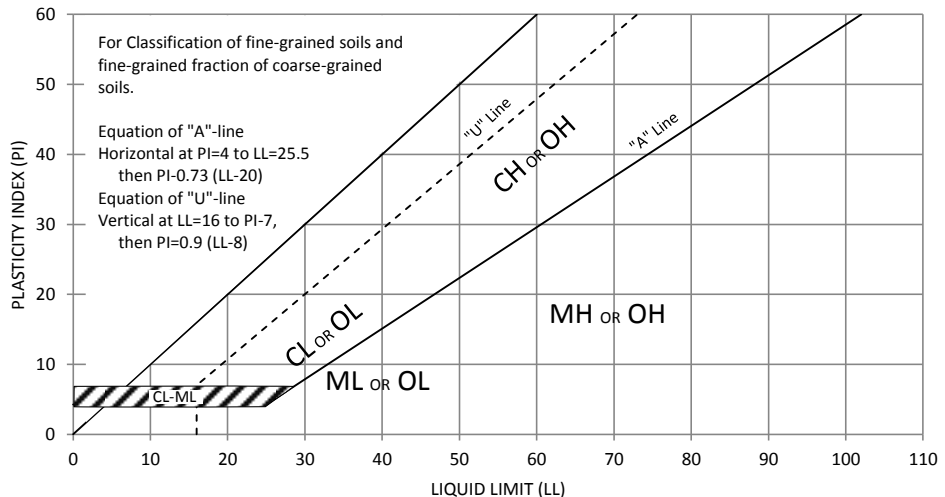

^P PI plots on or above "A" line.

^Q PI plots below "A" line.

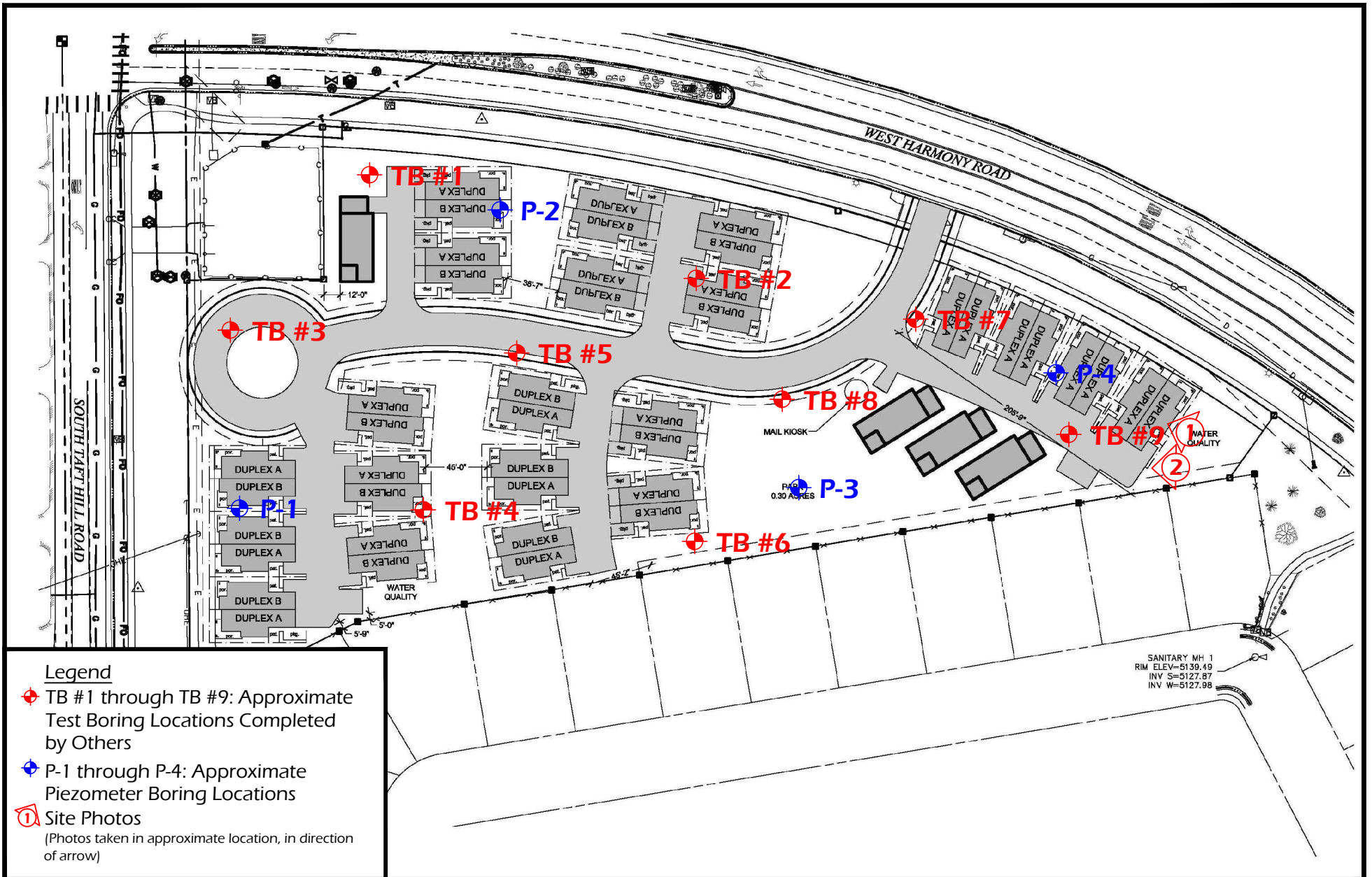



Legend

-  TB #1 through TB #9: Approximate Test Boring Locations Completed by Others
-  P-1 through P-4: Approximate Piezometer Boring Locations
-  Site Photos
 (Photos taken in approximate location, in direction of arrow)

Boring Location Diagram
 Habitat for Humanity - Ft Collins, Colorado
 EEC Project Number: 1152114
 November 2015

North
Not to Scale



PHOTO # 1



PHOTO # 2

HABITAT FOR HUMANITY
FORT COLLINS, COLORADO
EEC PROJECT No. 1152114
NOVEMBER 2015



**HABITAT FOR HUMANITY - HARMONY & TAFT
FORT COLLINS, COLORADO**

PROJECT NO: 1152114		LOG OF BORING P-1 (PIEZOMETER) SHEET 1 OF 1					DATE: NOVEMBER 2015				
RIG TYPE: CME55							WATER DEPTH				
FOREMAN: DG		START DATE	11/11/2015	WHILE DRILLING	None						
AUGER TYPE: 4" CFA		FINISH DATE	11/11/2015	AFTER DRILLING	N/A						
SPT HAMMER: AUTOMATIC		SURFACE ELEV	N/A	24 HOUR	None						
SOIL DESCRIPTION	TYPE	D	N	QU	MC	DD	A-LIMITS		-200	SWELL	
		(FEET)	(BLOWS/FT)	(PSF)	(%)	(PCF)	LL	PI	(%)	PRESSURE	% @ 500 PSF
SPARSE VEGETATION		1									
SANDY LEAN CLAY (CL) brown / red stiff to very stiff with calcareous deposits	CS	2									% @ 150 psf
		3	22	9000+	15.2	104.9	39	17	54.3	1200 psf	1.2%
		4									
	SS	5	18	7000	7.8						
		6									
		7									
		8									
cemented zone		9									
	CS	10	35	9000+	7.8	127.7	31	19	67.6	>8000 psf	14.0%
CLAYSTONE / SILTSTONE brown / grey / rust with calcareous deposits		11									
		12									
		13									
		14									
	SS	15	50	9000+	15.0						
BOTTOM OF BORING DEPTH 15.5'		16									
		17									
		18									
		19									
		20									
		21									
		22									
		23									
		24									
		25									

**HABITAT FOR HUMANITY - HARMONY & TAFT
FORT COLLINS, COLORADO**

PROJECT NO: 1152114		LOG OF BORING P-2 (PIEZOMETER)				DATE: NOVEMBER 2015					
RIG TYPE: CME55		SHEET 1 OF 1				WATER DEPTH					
FOREMAN: DG		START DATE	11/11/2015	WHILE DRILLING	None						
AUGER TYPE: 4" CFA		FINISH DATE	11/11/2015	AFTER DRILLING	N/A						
SPT HAMMER: AUTOMATIC		SURFACE ELEV	N/A		24 HOUR	None					
SOIL DESCRIPTION	TYPE	D	N	QU	MC	DD	A-LIMITS		-200	SWELL	
		(FEET)	(BLOWS/FT)	(PSF)	(%)	(PCF)	LL	PI	(%)	PRESSURE	% @ 500 PSF
SANDY LEAN CLAY (CL) brown / red very stiff to stiff with traces of gravel		1									
		2									
		3									
		4									
	CS	5	16	9000+	7.5	112.6	29	14	28.4	<500 psf	None
		6									
		7									
		8									
		9									
	SS	10	11	2000	18.0						
red with calcareous deposits		11									
		12									
		13									
		14									
SAND & GRAVEL (SP/GP) red medium dense	CS	15	32	--	3.4	122.2					
BOTTOM OF BORING DEPTH 15.0'		16									
		17									
		18									
		19									
		20									
		21									
		22									
		23									
		24									
		25									

HABITAT FOR HUMANITY - HARMONY & TAFT

FORT COLLINS, COLORADO

PROJECT NO: 1152114		LOG OF BORING P-3 (PIEZOMETER)					DATE: NOVEMBER 2015				
RIG TYPE: CME55		SHEET 1 OF 1					WATER DEPTH				
FOREMAN: DG		START DATE	11/11/2015	WHILE DRILLING	None						
AUGER TYPE: 4" CFA		FINISH DATE	11/11/2015	AFTER DRILLING	N/A						
SPT HAMMER: AUTOMATIC		SURFACE ELEV	N/A	24 HOUR	None						
SOIL DESCRIPTION	TYPE	D	N	QU	MC	DD	A-LIMITS		-200	SWELL	
		(FEET)	(BLOWS/FT)	(PSF)	(%)	(PCF)	LL	PI	(%)	PRESSURE	% @ 500 PSF
SPARSE VEGETATION		1									
SANDY LEAN CLAY (CL)		2									
brown											
very stiff											% @ 150 psf
with traces of gravel	CS	3	36	9000+	5.9	127.8	28	15	53.1	1300 psf	3.2%
		4									
CLAYEY SAND (SC)	SS	5	18	9000+	7.0						
brown / red		6									
medium dense to dense		7									
		8									
cemented zone		9									
red, with gravel	CS	10	45	9000	2.1	131.5					
		11									
		12									
		13									
		14									
CLAYSTONE / SILTSTONE	SS	15	35/8"	9000+	15.6						
brown / grey / rust		16									
BOTTOM OF BORING DEPTH 15.5'		17									
		18									
		19									
		20									
		21									
		22									
		23									
		24									
		25									

**HABITAT FOR HUMANITY - HARMONY & TAFT
FORT COLLINS, COLORADO**

PROJECT NO: 1152114		LOG OF BORING P-4 (PIEZOMETER) SHEET 1 OF 1					DATE: NOVEMBER 2015				
RIG TYPE: CME55							WATER DEPTH				
FOREMAN: DG		START DATE	11/11/2015		WHILE DRILLING		None				
AUGER TYPE: 4" CFA		FINISH DATE	11/11/2015		AFTER DRILLING		N/A				
SPT HAMMER: AUTOMATIC		SURFACE ELEV	N/A		24 HOUR		None				
SOIL DESCRIPTION		D	N	QU	MC	DD	A-LIMITS		-200	SWELL	
TYPE	(FEET)	(BLOWS/FT)	(PSF)	(%)	(PCF)	LL	PI	(%)	PRESSURE	% @ 500 PSF	
SPARSE VEGETATION		--									
	1										
SAND & GRAVEL (SP/GP) brown / red medium dense		--									
	2										
	3										
	4										
CS	5	14	--	2.8		28	14	14.1			
	6										
	7										
	8										
	9										
CLAYEY SAND & GRAVEL (SC), brown / red		--									
SS	10	38/10"	9000+	13.8							
CLAYSTONE brown / grey / rust		--									
	11										
	12										
	13										
	14										
CS	15	50/5"	9000+	12.1	123.4						
BOTTOM OF BORING DEPTH 15.0'		--									
	16										
	17										
	18										
	19										
	20										
	21										
	22										
	23										
	24										
	25										

SWELL / CONSOLIDATION TEST RESULTS

Material Description: Brown / Red Sandy Lean Clay (CL)		
Sample Location: Boring 1, Sample 1, Depth 2'		
Liquid Limit: 39	Plasticity Index: 17	% Passing #200: 54.3%
Beginning Moisture: 15.2%	Dry Density: 101.3 pcf	Ending Moisture: 25.5%
Swell Pressure: 1200 psf		% Swell @ 150: 1.2%

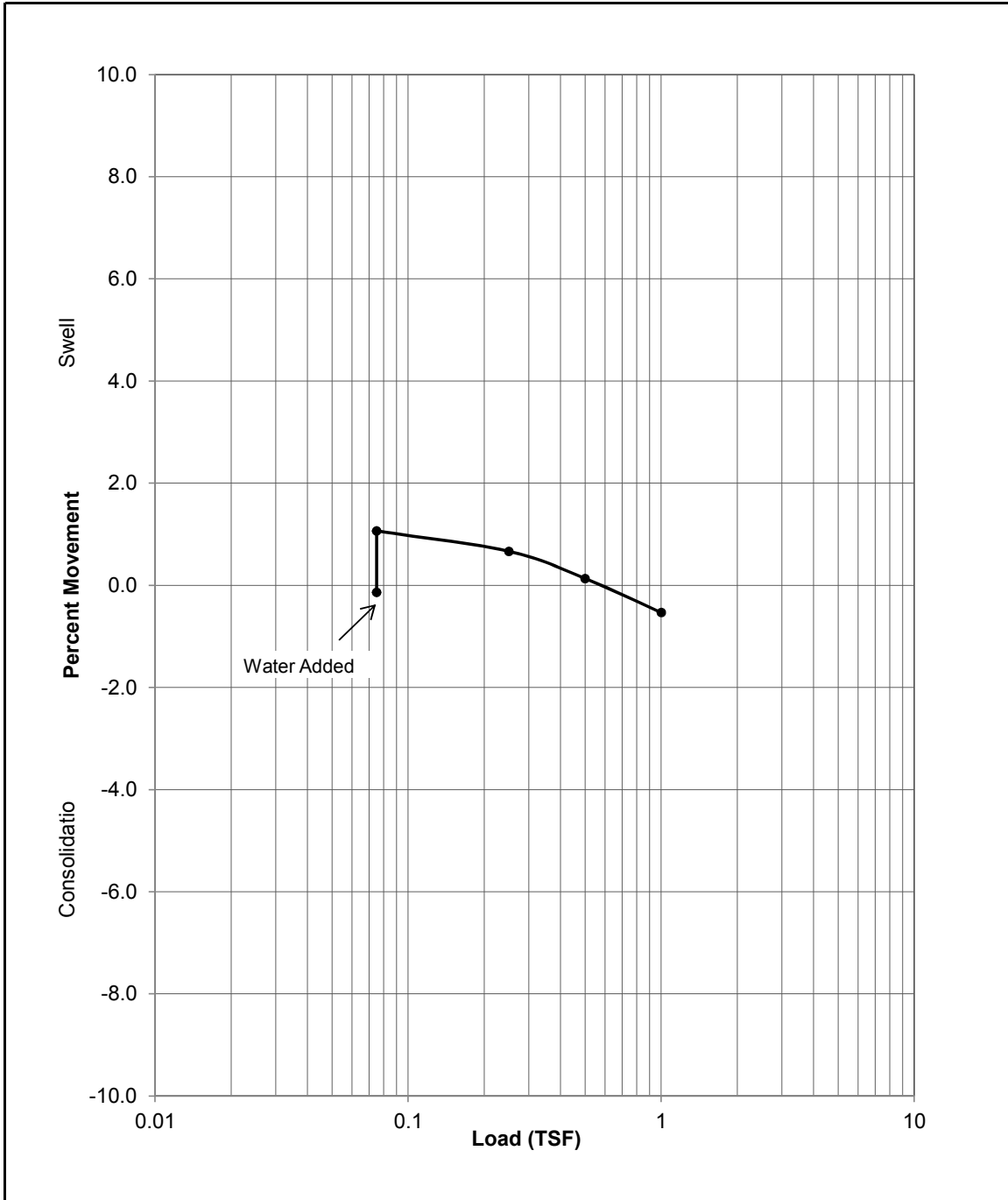

Project: Habitat for Humanity - Harmony & Taft
 Location: Fort Collins, Colorado
 Project #: 1152114
 Date: November 2015



SWELL / CONSOLIDATION TEST RESULTS

Material Description: Brown/Grey/Rust Claystone/Siltstone		
Sample Location: Boring 1, Sample 3, Depth 9'		
Liquid Limit: 31	Plasticity Index: 19	% Passing #200: 67.6%
Beginning Moisture: 7.8%	Dry Density: 132 pcf	Ending Moisture: 17.6%
Swell Pressure: >8,000 psf		% Swell @ 500: 14.0%

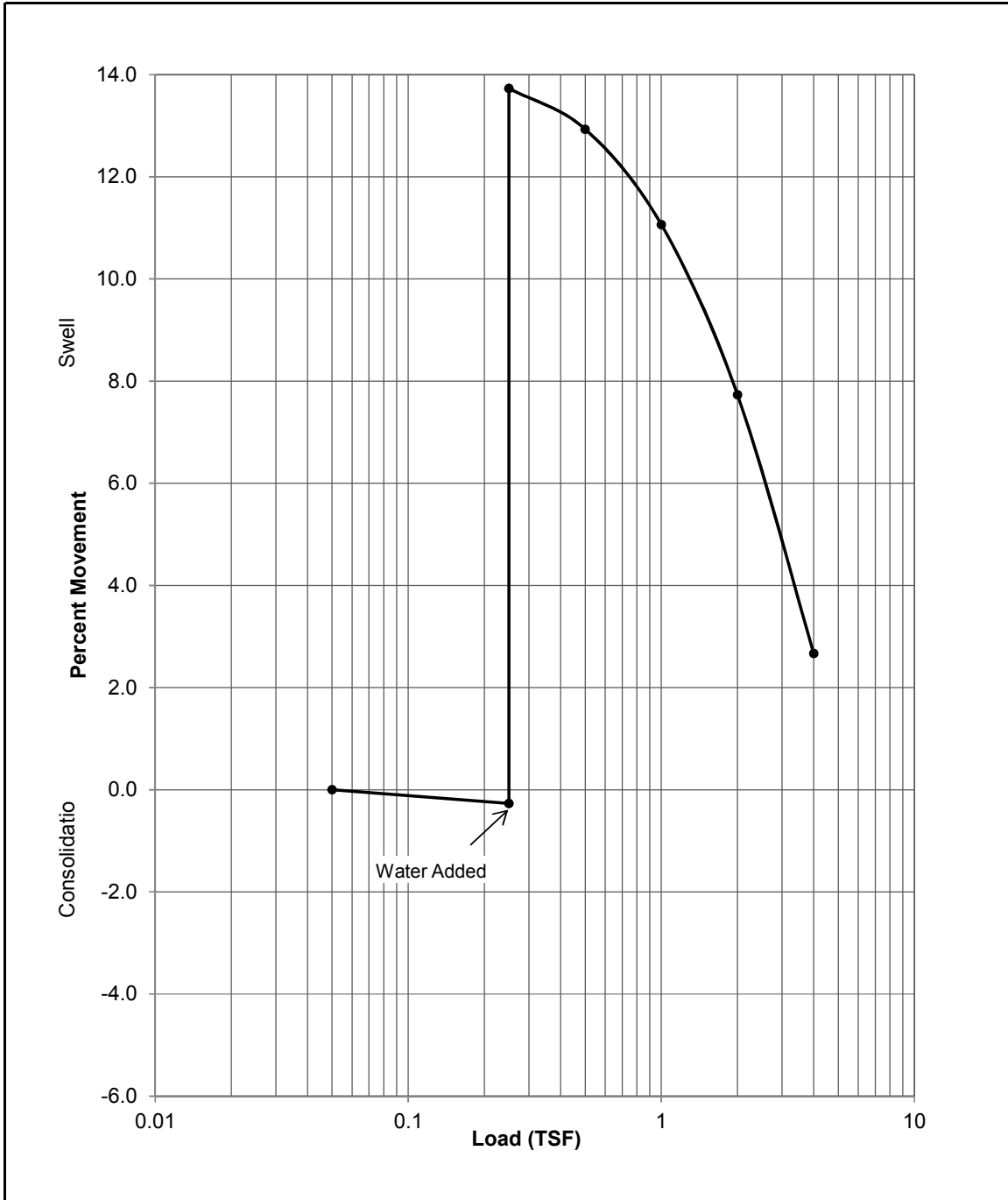

Project: Habitat for Humanity - Harmony & Taft
 Location: Fort Collins, Colorado
 Project #: 1152114
 Date: November 2015



SWELL / CONSOLIDATION TEST RESULTS

Material Description: Brown / Red Sandy Lean Clay (CL)		
Sample Location: Boring 2, Sample 1, Depth 4'		
Liquid Limit: 29	Plasticity Index: 14	% Passing #200: 28.4%
Beginning Moisture: 7.5%	Dry Density: 123.3 pcf	Ending Moisture: 13.5%
Swell Pressure: <500 psf		% Swell @ 500: None

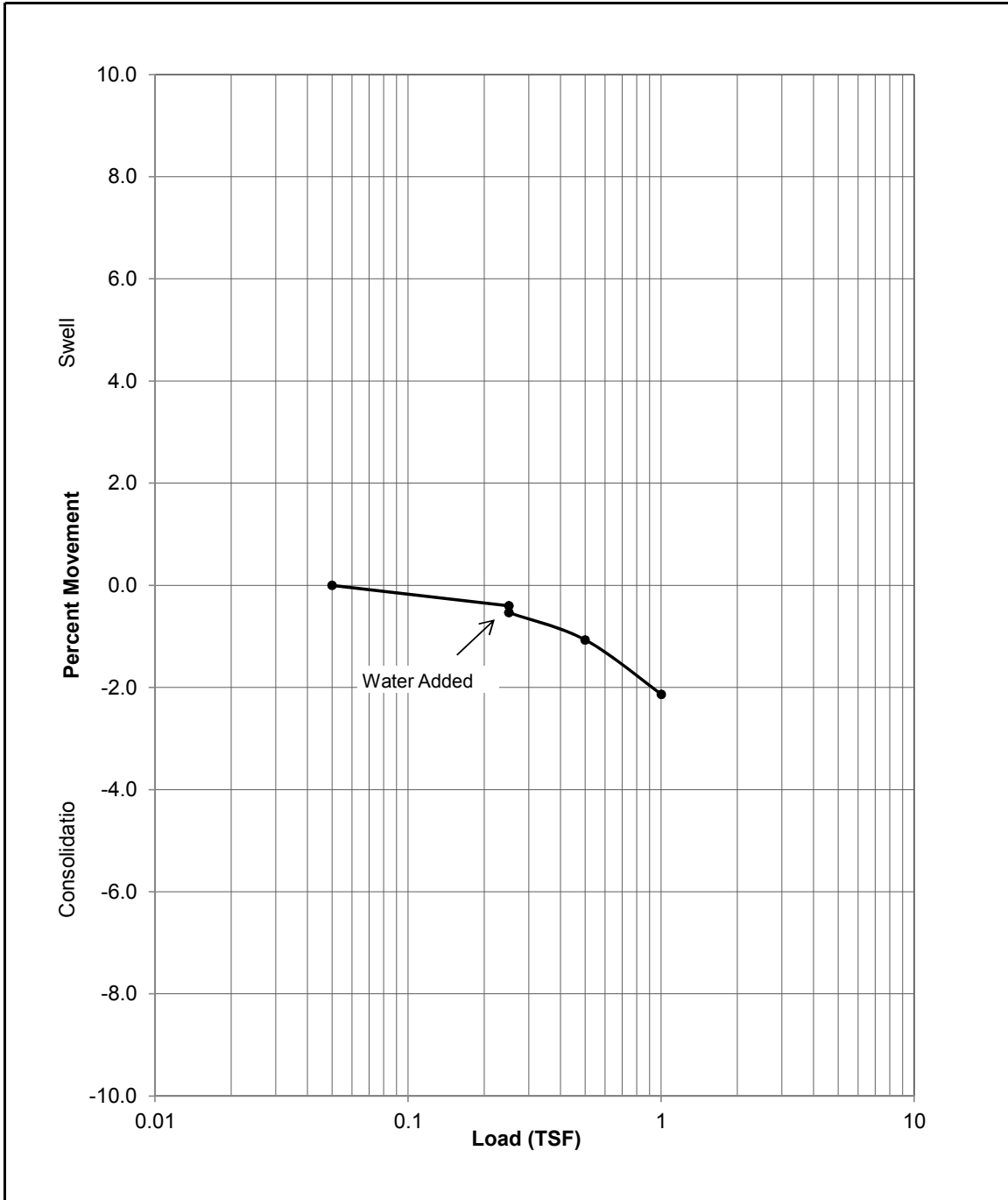

Project: Habitat for Humanity - Harmony & Taft
 Location: Fort Collins, Colorado
 Project #: 1152114
 Date: November 2015



SWELL / CONSOLIDATION TEST RESULTS

Material Description: Brown Sandy Lean Clay (CL)		
Sample Location: Boring 3, Sample 1, Depth 2'		
Liquid Limit: 28	Plasticity Index: 15	% Passing #200: 53.1%
Beginning Moisture: 5.9%	Dry Density: 124.8 pcf	Ending Moisture: 13.6%
Swell Pressure: 1300 psf		% Swell @ 150: 3.2%

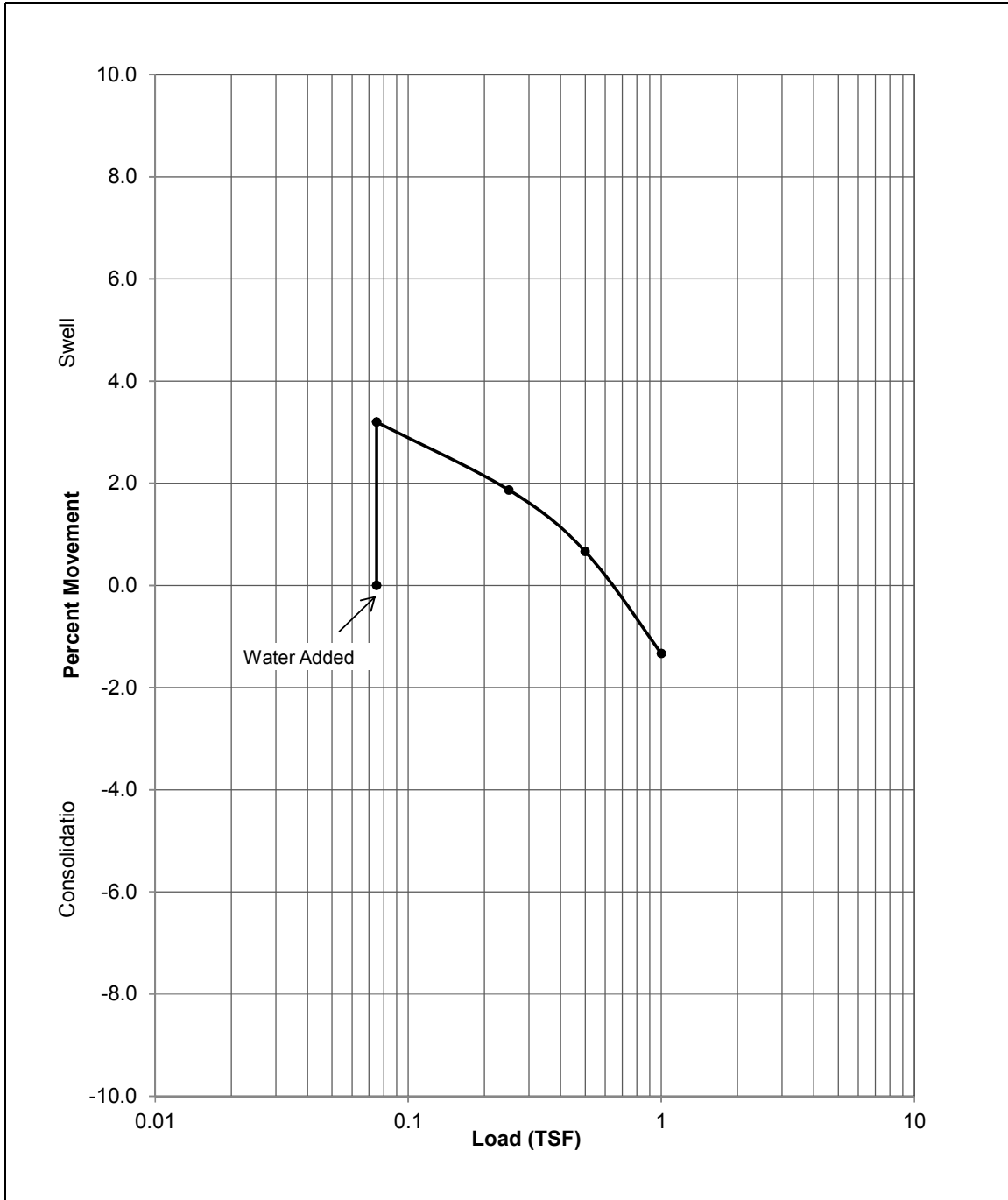

Project: Habitat for Humanity - Harmony & Taft
 Location: Fort Collins, Colorado
 Project #: 1152114
 Date: November 2015



PRELIMINARY DRAINAGE REPORT

Harmony Cottages

Prepared for:

Habitat for Humanity
4001 S. Taft Hill Road
Fort Collins, CO 80525
(970) 223-4522

Prepared by:

Interwest Consulting Group
1218 West Ash, Suite A
Windsor, Colorado 80550
(970) 674-3300

January 20, 2016

Job Number 1255-028-00

January 20, 2016

Ms. Heather McDowell
City of Fort Collins Stormwater
700 Wood Street
Fort Collins, CO 80522-0580

RE: Preliminary Drainage Report for Harmony Cottages

Dear Heather,

I am pleased to submit for your review and approval, this Preliminary Drainage Report for the Harmony Cottages development. I certify that this report for the drainage design was prepared in accordance with the criteria in the City of Fort Collins Storm Drainage Manual.

I appreciate your time and consideration in reviewing this submittal. Please call if you have any questions.

Sincerely,

Erika Schneider, P.E.
Colorado Professional
Engineer No. 41777

Skylar Brower
Colorado Professional
Engineer No. 44248

TABLE OF CONTENTS

TABLE OF CONTENTS	iii
1. GENERAL LOCATION AND DESCRIPTION	1
1.1 Location	1
1.2 Description of Property	1
1.3 Floodplain Submittal Requirements	2
2. DRAINAGE BASINS AND SUB-BASINS	2
2.1 Major Basin Description	2
2.2 Sub-basin Description	2
3. DRAINAGE DESIGN CRITERIA	3
3.1 Regulations	3
3.2 Directly Connected Impervious Area (DCIA) Discussion	3
3.3 Development Criteria Reference and Constraints	4
3.4 Hydrological Criteria	5
3.5 Hydraulic Criteria	5
3.6 Floodplain Regulations Compliance	6
3.7 Modifications of Criteria	6
4. DRAINAGE FACILITY DESIGN	6
4.1 General Concept	6
4.2 Specific Details	6
4.3 Stormwater Detention	7
4.4 Water Quality Treatment	7
5. CONCLUSIONS	9
5.1 Compliance with Standards	9
5.2 Drainage Concept	9
6. REFERENCES	9
 APPENDIX	
VICINITY MAP AND DRAINAGE PLAN	A
HYDROLOGIC COMPUTATIONS	B
HYDRAULIC COMPUTATIONS (PROVIDED AT FINAL)	C
STORMWATER DETENTION POND ANALYSIS	D
WATER QUALITY AND LID INFORMATION	E
EXCERPTS FROM REFERENCE REPORTS	F
SOIL REPORT AND FEMA INFORMATION	G

1. GENERAL LOCATION AND DESCRIPTION

1.1 Location

The Harmony Cottages development is located in Fort Collins. It is located in the Southwest ¼ of Section 34, Township 7 North, Range 69 West of the 6th Principal Meridian in the City of Fort Collins, Larimer County, Colorado. Please refer to the vicinity map in Appendix A.

The project site is located in the southeast corner of Harmony Road (County Road 38E) and Taft Hill Road in southwest Fort Collins, Colorado. The site is bounded by Harmony Road on the north and east, Taft Hill Road on the west, and The Overlook at Woodridge Fourth Filing on the south. Adjacent to the northeast corner of the site is a water pump station owned by the Fort Collins-Loveland Water District. The legal description of the site is a replat of Lots 1 and 2, Innovation Island.

1.2 Description of Property

The project is a site development of a Habitat for Humanity neighborhood. The property consists of 4.45 acres of land and lots will be designed for single family and duplex housing units with private drive through aisles and parking areas.

The site currently consists of open space and is sparsely vegetated with native plants and grasses. Offsite flow contributing to the site includes adjacent public street right-of-way and the FCLWD parcel.

The soils in the area are predominately Altan-Satanta loams (86.3%), 0-3 percent slopes (soil number 3), Hydrologic Soil Group B and Fort Collins loam (13.7%), 0-3 percent slopes (soil number 35), Hydrologic Soil Group C as reported in the Soil Survey of Larimer County Area, Colorado.

According to FEMA Panel 08069C1000F there are no mapped FEMA Floodways on this property. Please refer to Appendix G for the NRCS soils report and FEMA information.

1.3 Floodplain Submittal Requirements

Because the project is not within any FEMA or City of Fort Collins mapped floodway, a Floodplain Submittal is not required and a “City of Fort Collins Floodplain Review Checklist for 50% Submittals” has not been included with this report.

2. DRAINAGE BASINS AND SUB-BASINS

2.1 Major Basin Description

The site is located on the upper end of the Mail Creek Drainage Basin. This site is known as sub-basin 89 in the master drainage plan and there are no offsite flows that pass through this site. The impervious area for the site was assumed to be 95% in the master plan. Excerpts from the “Mail Creek Basin Master Drainage Plan Hydrology Technical Appendix” are included in Appendix F of this report.

This site is also included in the “Master Drainage Study for Woodridge” (1991) and the “Final Drainage and Erosion Control Study for the Overlook at Woodridge, Fourth Filing” (1995). In the Final Drainage Report for the Overlook at Woodridge Fourth Filing, this site is known as Basin 1 and 2A. These basins were considered to be neighborhood commercial sites with a C-value of 0.85. Fully developed commercial flows from this site were considered in the stormwater system plan design for the Overlook at Woodridge. Excerpts from the “Final Drainage and Erosion Control Study for the Overlook at Woodridge, Fourth Filing” report are included in Appendix F of this report.

2.2 Sub-basin Description

The southern portion of the site drains to an existing swale which carries stormwater runoff along the south property line to a depression and into a concrete pipe located in Tract A of the Overlook at Woodridge. The remaining portion of the site drains via overland flow to the curb and gutter along Harmony Road and into two existing 15’ type R inlets on the south side of Harmony Road. All of the stormwater runoff from the site is conveyed to the existing stormwater conveyance system in Harmony Road which passes to the existing concrete lined drainage channel north of Seneca Drive and then to the existing regional detention pond located adjacent to Webber Middle School.

3. DRAINAGE DESIGN CRITERIA

3.1 Regulations

This report was prepared to meet or exceed the “City of Fort Collins Storm Drainage Design Criteria Manual” specifications. Where applicable, the criteria established in the “Urban Storm Drainage Criteria Manual” (UDFCD), developed by the Denver Regional Council of Governments, has been used.

3.2 Directly Connected Impervious Area (DCIA) Discussion

Urban Drainage and Flood Control District (UDFCD) recommends a Four Step Process for receiving water protection that focuses on reducing runoff volumes, treating the water quality capture volume (WQCV), stabilizing drainageways and implementing long-term source controls. The Four Step Process applies to the management of smaller, frequently occurring events.

Step 1: Employ Runoff Reduction Practices

To reduce runoff peaks, volumes, and pollutant loads from urbanizing areas, implement Low Impact Development (LID) strategies, including Minimizing Directly Connected Impervious Areas (MDCIA).

Runoff for the northern portion of the site will be routed through porous pavement systems and a rain garden reducing runoff from impervious surfaces over permeable areas to slow runoff and increase the time of concentration and promote infiltration. Runoff from the southern portion of the site will be routed through porous pavement systems, a grass swale, and a second rain garden thereby slowing runoff and also promoting infiltration.

Step 2: Implement BMPs that Provide a Water Quality Capture Volume with Slow Release

95% of the proposed impervious area will be routed through an LID facility; therefore, no additional water quality capture volume is proposed with these improvements.

Step 3: Stabilize Drainageways

Natural Drainageways are subject to bed and bank erosion due to increases in frequency, duration, rate and volume of runoff during and following development. Because the site will drain to an existing storm system, bank stabilization is unnecessary with this project.

Step 4: Implement Site Specific and Other Source Control BMPs

Proactively controlling pollutants at their source by preventing pollution rather than removing contaminants once they have entered the stormwater system or receiving waters is important when protecting storm systems and receiving waters. This can be accomplished through site specific needs such as construction site runoff control, post-construction runoff control and pollution prevention / good housekeeping. It will be the responsibility of the contractor to develop a procedural best management practice for the site.

3.3 Development Criteria Reference and Constraints

The runoff from this site has been routed to conform to the requirements of the City Stormwater Department and the Mail Creek Basin Master Drainage Plan. Water quality capture volume will be provided on site. The impervious area for the site was assumed to be 95% in the master plan. The proposed weighted average impervious area for the proposed site is 50% which is less than the master plan.

Fully developed commercial flows from this site were considered in the stormwater system plan design for the Overlook at Woodridge. The correlating basins 1 and 2A were considered to be neighborhood commercial sites with a C-value of 0.85. The proposed weighted average C-value of the proposed site is 0.55 which is less than the original design and therefore, downstream stormwater system will have capacity. Please refer to supporting documentation in Appendix F.

	Correlating Basin ID	%I	C-value
Master Plan	89	95	-
Woodridge 4th	1, 2A	-	0.85
Site	A, B	50	0.55

Runoff reduction practices (LID techniques) are also required. No less than fifty percent of any newly added impervious area must be treated using one or a combination of LID techniques. The project adds 110,940 sf of new impervious area. Using the porous paver and rain garden LID techniques, 163,604 sf of new impervious area (147%) will be treated which exceeds the 50% requirement. In anticipation of the new LID code which will require 75% of newly added impervious area to be treated by an LID technique, the rain gardens have been sized to treat the entire site with the assumption that the porous pavers are removed. Using the rain garden LID technique, 105,796 sf of new impervious area (95%) will be treated which exceed the 75% requirement.

No less than twenty five percent of any newly added pavement areas must be treated using a permeable pavement technology. The project adds 27,679 sf of new pavement area. This project will incorporate 7,427 sf of porous pavers which is 27% of the newly added pavement which exceeds the required 25%. As previously mentioned, this project is set up to provide the option of removing the porous pavers during final design with the assumption that the newly proposed LID code is implemented by the City.

Please refer to Appendix E for LID calculations and information.

3.4 Hydrologic Criteria

Runoff computations were prepared for the 2- and 10-year minor and 100-year major storm frequency utilizing the rational method.

All hydrologic calculations associated with the basins are included in Appendix B of this report. Standard Form 8 (SF-8) provides time of concentration calculations for all sub-basins. Standard Form 9 (SF-9) provides a summary of the design flows for all Sub-basins and Design Points associated with this site.

3.5 Hydraulic Criteria

All hydraulic calculations will be presented in the final drainage report and prepared in accordance with the City of Fort Collins Drainage Criteria.

3.6 Floodplain Regulations Compliance

The project is not within any FEMA or City of Fort Collins mapped floodway; therefore, Floodplain Regulations Compliance is not required.

3.7 Modifications of Criteria

There are no Modifications of Criteria at this time.

4. DRAINAGE FACILITY DESIGN

4.1 General Concept

The proposed site generally follows the existing drainage patterns and is divided into two major drainage basins. The site will be further divided into more sub-basins during final compliance.

4.2 Specific Details

A summary of the drainage patterns within each basin is provided in the following paragraphs. Please refer to Appendix A for the drainage plan.

Basin A is 1.77 acres and includes the southern portion of the proposed site and a small off-site area adjacent to Taft Hill Road. Stormwater is conveyed via overland flow to the proposed grass swale that runs west to east along the southern property boundary. This south swale discharges into the proposed rain garden in the southeast corner of the property located at design point a. The outlet pipe for the rain garden discharges to the existing storm drain inlet #21 located on the south side of Harmony Road.

Basin B is 2.85 acres and includes the northern portion of the site and offsite area from the FCLWD parcel and area adjacent to Taft Hill Road. This basin is conveyed via overland flow to the porous paver systems and rain garden located at the southwest corner of the intersection of the driveway and Harmony Road. The outlet pipe for the rain garden discharges to the existing 15' Type R inlet #10 located on the south side of Harmony Road.

Basin OS-3 is 0.32 acres and includes the north half of the roofs of 5 lots from the Overlook at Woodridge, P.U.D. Fourth Filing adjacent to basin A. This basin sheet flows to the southern grass swale.

Basin OS-10 is 0.94 acres and includes the south half of the roadway of Harmony Road adjacent to basin B and a small portion of the site adjacent to Harmony Road. This off-site basin will be further divided showing on-site and off-site areas during final compliance. This basin is conveyed via gutter flow to the existing 15' Type R inlet #10 in Harmony Road.

Basin OS-21 is 0.54 acres and includes the south half of the roadway of Harmony Road adjacent to basin A and a small portion of the site adjacent to Harmony Road. This off-site basin will be further divided showing on-site and off-site areas during final compliance. This basin is conveyed via gutter flow to the existing 15' Type R inlet #21 in Harmony Road.

4.3 Stormwater Detention

Developed commercial flows from this site were accounted for in the design of the storm drainage detention pond for the Overlook at Woodridge Fourth Filing (1995). Since the time that the Final Drainage Study for the Overlook was completed, the City of Fort Collins (CFC) has modified their stormwater design criteria to include stormwater quality enhancement requirements and the use of a larger design storm based on a 1998 precipitation study. The peak discharge using the old rainfall data for the site only (4.45 acres) and a C 100-year value of 1.00 was calculated to be 40.1-cfs. The required detention volume under the new rainfall conditions with a release rate set to the peak discharge under the old rainfall conditions and a developed C 100-year value of 0.70 was calculated. The result was a detention requirement of -0.04 ac-ft with a storm duration of 5 minutes. Therefore, adequate stormwater detention is being provided and additional detention is not required based on the increase in the design rainfall rates.

4.4 Water Quality Treatment

Water quality enhancement is being provided for fully developed conditions. Four water quality enhancement measures will be used on this site. 95% of the impervious area on

site will be directed to an LID facility. Therefore, no water quality capture volume is required for this site.

The first water quality enhancement measure is the rain garden in the east corner of the site which is referred to as rain garden A. The rain garden is a depressed landscape area designed to capture and infiltrate the water quality capture volume. This area has an average depth of 12", has a flat bottom and will include landscape plantings in 12" depth of a sand media mixture. Water will be held in the depressed area and slowly drain through the sand media and then hit a 4" perforated pipe in gravel bedding which will discharge ultimately to the existing storm system in Harmony Road. This rain garden will treat 0.02 ac-ft of the water quality capture volume.

The second water quality enhancement measure is the rain garden adjacent to Harmony and the main driveway which is referred to as rain garden B. The rain garden is a depressed landscape area designed to capture and infiltrate the water quality capture volume. This area has an average depth of 12", has a flat bottom and will include landscape plantings in 12" depth of a sand media mixture. Water will be held in the depressed area and slowly drain through the sand media and then hit a 4" perforated pipe in gravel bedding which will discharge ultimately to the existing storm system in Harmony Road. This rain garden will treat 0.04 ac-ft of the water quality capture volume.

The third water quality enhancement measure is the grass swale located along the south property line. The swale has been designed to have a low longitudinal slope in order to convey flow in a slow and shallow manner promoting sedimentation and filtration and limiting erosion. The bottom of the swale is not concrete lined in order to further enhance pollutant removal. The swale will be constructed with a 'soft pan' bottom consisting of a sand/topsoil mix or will be constructed with an underdrain in order to minimize standing water in the swale.

The fourth water quality enhancement measure is the porous pavement systems located throughout the pavement area. These systems allow the movement of water into the layers below the pavement surface where treatment and slow release occurs. These systems also reduce the effective imperviousness of the site.

There is a small portion of the site immediately adjacent to Harmony Road which will not

pass through a water quality feature but will flow directly to the street gutter and into the stormwater system. The majority of this area is landscaped with grass and plantings and only a small amount of impervious area from the sidewalk and roof is included. Since the source of the majority of pollutants in stormwater runoff comes from driveway and parking areas, this small amount of untreated runoff should have a negligible effect on the overall pollutant load. Several off-site areas will be conveyed through the site and treated on-site including the FCLWD parcel and the area adjacent to Taft Hill Road and this property.

5. CONCLUSIONS

5.1 Compliance with Standards

All computations that have been completed within this report are in compliance with the City of Fort Collins Storm Drainage Design Criteria Manual.

5.2 Drainage Concept

The proposed drainage concepts presented in this report and on the construction plans adequately provides for stormwater quantity and quality treatment of proposed impervious areas. Conveyance elements have been designed to pass required flows and to minimize future maintenance.

If, at the time of construction, groundwater is encountered, a Colorado Department of Health Construction Dewatering Permit will be required.

6. REFERENCES

1. City of Fort Collins, "Fort Collins Stormwater Criteria Manual Amendments to the Urban Drainage and Flood Control District Criteria Manual", adopted December 2011.
2. Urban Drainage and Flood Control District, "Urban Storm Drainage Criteria Manual", Volumes 1 and 2, dated June 2001, and Volume 3 dated November 2015.

3. Ayers Associates, "Alternative Analysis for the Design of the Mason Street Outfall", dated November 2010.
4. RBD, Inc. Engineering Consultants, "Preliminary/Master Drainage Study for Woodridge", dated December 2, 1991.
5. RBD, Inc. Engineering Consultants, "Final Drainage and Erosion Control Study for the Overlook at Woodridge Fourth Filing, Phase One", dated June 14, 1995.

APPENDIX A

VICINITY MAP AND DRAINAGE PLAN

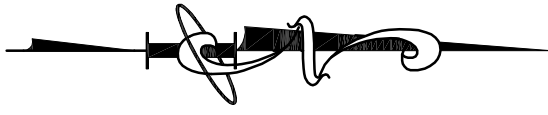

VICINITY MAP

APPROX. 1" = 1000'

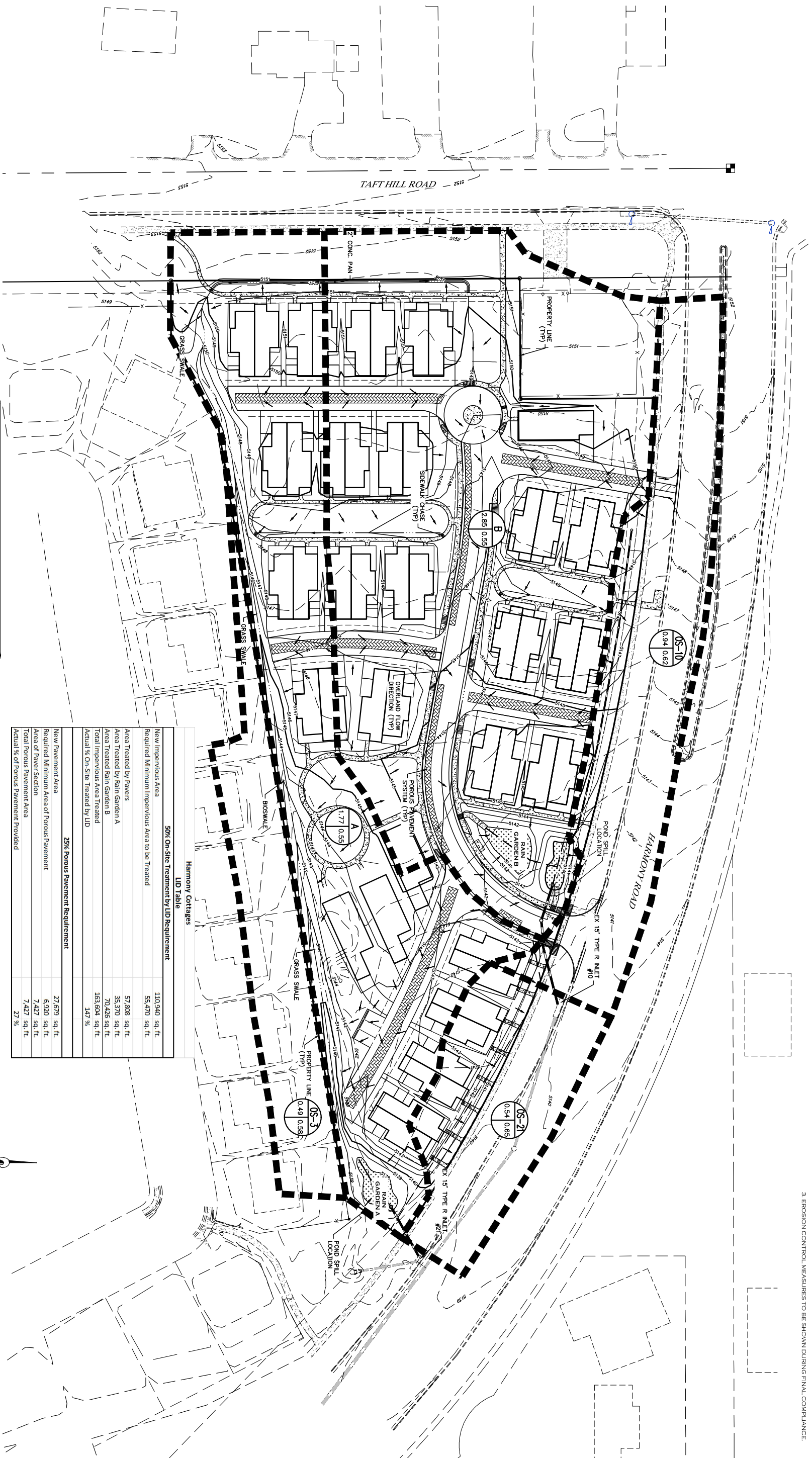

PRELIMINARY
NOT FOR CONSTRUCTION

LEGEND



DRAINAGE SUMMARY TABLE

Design Point	Sub-basin (ac)	C (10)	C (100)	tc (10) (min)	tc (100) (min)	Q20min (cfs)	Q10min (cfs)	Q100min (cfs)	REMARKS
8	A	1.17	0.65	0.68	7.7	8.8	2.4	4.1	W/O Pond
B	B	2.85	0.65	0.68	14.0	12.3	3.0	5.2	Rain Garden
10	OS-10	0.84	0.62	0.78	6.5	7.8	1.4	2.4	EX TIE #10
21	OS-21	0.54	0.65	0.81	5.0	5.0	1.0	1.7	EX TIE #21
3	OS-3	0.49	0.56	0.73	6.5	7.6	0.7	1.2	Bioswale

50% On-Site Treatment by LID Requirement	
New Impervious Area	110,940 sq. ft.
Required Minimum Impervious Area to be Treated	55,470 sq. ft.
Area Treated by Pavers	57,808 sq. ft.
Area Treated by Rain Garden A	35,370 sq. ft.
Area Treated Rain Garden B	70,425 sq. ft.
Total Impervious Area Treated	163,604 sq. ft.
Actual % of On-Site Treated by LID	147 %

25% Porous Pavement Requirement	
New Pavement Area	27,679 sq. ft.
Required Minimum Area of Porous Pavement	6,920 sq. ft.
Area of Paver Section	7,427 sq. ft.
Total Porous Pavement Area	7,427 sq. ft.
Actual % of Porous Pavement Provided	27 %

Harmony Cottages LID Table

50% On-Site Treatment by LID Requirement	
New Impervious Area	110,940 sq. ft.
Required Minimum Impervious Area to be Treated	55,470 sq. ft.
Area Treated by Pavers	57,808 sq. ft.
Area Treated by Rain Garden A	35,370 sq. ft.
Area Treated Rain Garden B	70,425 sq. ft.
Total Impervious Area Treated	163,604 sq. ft.
Actual % of On-Site Treated by LID	147 %

- NOTES:**
1. SEE LANDSCAPE PLAN FOR PLANTINGS THROUGHOUT THE SITE.
 2. THE TOP OF FOUNDATION ELEVATION SHOWN IS HIGHER THAN THE MINIMUM ELEVATION REQUIRED FOR PROTECTION FROM THE 100-YEAR STORM.
 3. EROSION CONTROL MEASURES TO BE SHOWN DURING FINAL COMPLIANCE.

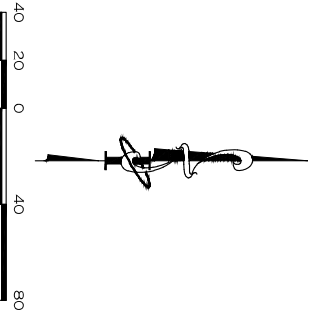

CALL UTILITY NOTIFICATION CENTER OF COLORADO
811
CALL 2-BUSINESS DAYS IN ADVANCE BEFORE YOU DIG, GRADE, OR EXCAVATE FOR THE MEMBER UTILITIES.

DATE: 01/20/16
SCALE (H): 1"=40'
SCALE (V): N/A
DESIGNED BY: SB
CHECKED BY: RA

PROJECT NAME
HARMONY COTTAGES

DRAINAGE PLAN

PREPARED FOR
HABITAT FOR HUMANITY
4001 S. TAFT HILL ROAD
FORT COLLINS, CO 80525
PHONE: 970.223.4522



1218 W. Ash, Suite A
Windsor, Colorado 80550
Phone: (970) 674-3300
Fax: (970) 674-3303

INTEREST CONSULTING GROUP

APPENDIX B

HYDROLOGIC COMPUTATIONS

RUNOFF COEFFICIENTS & % IMPERVIOUS

LOCATION: *Harmony Cottages*
 PROJECT NO: *1255-028-00*
 COMPUTATIONS BY: *es*
 DATE: *12/8/2015*

Recommended Runoff Coefficients from Table RO-11 of City of Fort Collins Stormwater Code, Volume I
 Recommended % Impervious from Table RO-3 Urban Storm Drainage Criteria Manual, Volume I

Type B Soils

	Runoff coefficient C	% Impervious
Streets, parking lots (asphalt):	0.95	100
Sidewalks (concrete):	0.95	96
Roofs:	0.95	90
Pavers:	0.50	40
Lawns, sandy soil (Flat <2%) :	0.10	0

SUBBASIN DESIGNATION	TOTAL AREA (ac.)	TOTAL AREA (sq.ft)	ROOF AREA (sq.ft)	PAVED AREA (sq.ft)	PAVERS AREA (sq.ft)	CONCRETE AREA (sq.ft)	LANDSCAPE AREA (sq.ft)	RUNOFF COEFF. (C)	% Impervious	REMARKS
Existing										
Lot	4.45	193,839	0	0	0	0	193,839	0.10	0	
Proposed										
Lot	4.45	193,839	46,267	6,641	7,427	47,000	86,504	0.55	50	
1, 2A	6.54	BASED ON WOODRIDGE 4TH FILING						0.85		
89	5.90	BASED ON MASTER DRAINAGE PLAN							95	

Equations

- Calculated C coefficients & % Impervious are area weighted

$$C = \Sigma (C_i A_i) / A_t$$

C_i = runoff coefficient for specific area, A_i

A_i = areas of surface with runoff coefficient of C_i

n = number of different surfaces to consider

A_t = total area over which C is applicable; the sum of all A_i's

RUNOFF COEFFICIENTS & % IMPERVIOUS

LOCATION: *Harmony Cottages*
 PROJECT NO: *1255-028-00*
 COMPUTATIONS BY: *es*
 DATE: *12/8/2015*

Recommended Runoff Coefficients from Table RO-11 of City of Fort Collins Stormwater Code, Volume I
 Recommended % Impervious from Table RO-3 Urban Storm Drainage Criteria Manual, Volume I

Type B Soils

	Runoff coefficient C	% Impervious
Streets, parking lots (asphalt):	0.95	100
Sidewalks (concrete):	0.95	96
Roofs:	0.95	90
Gravel or Pavers:	0.50	40
Lawns, sandy soil (Flat <2%):	0.10	0

SUBBASIN DESIGNATION	TOTAL AREA (ac.)	TOTAL AREA (sq.ft)	ROOF AREA (sq.ft)	PAVED AREA (sq.ft)	PAVERS AREA (sq.ft)	SIDEWALK AREA (sq.ft)	LANDSCAPE AREA (sq.ft)	RUNOFF COEFF. (C)	% Impervious	REMARKS
A	1.77	77,160						0.55	50	
B	2.85	124,007						0.55	50	
<i>BASED ON OVERALL LOT CALCS</i>										
OS-10	0.94	41,146	223	22,062	0	3,121	15,739	0.62	61	
OS-21	0.54	23,355	3,310	9,154	0	2,593	8,298	0.65	63	
OS-3	0.49	21,503						0.58		
<i>BASED ON WOODRIDGE 4TH FILING</i>										

Equations

- Calculated C coefficients & % Impervious are area weighted

$$C = \Sigma (C_i A_i) / A_t$$

C_i = runoff coefficient for specific area, A_i

A_i = areas of surface with runoff coefficient of C_i

n = number of different surfaces to consider

A_t = total area over which C is applicable; the sum of all A_i's

**STANDARD FORM SF-2
TIME OF CONCENTRATION - 2 and 10 YR**

LOCATION: Harmony Cottages
 PROJECT NO: 1255-028-00
 COMPUTATIONS BY: es
 DATE: 12/8/2015

2 and 10-yr storm Cf = 1.00 from Table RO-12 of City of Fort Collins Stormwater Code, Volume I

SUB-BASIN DATA			INITIAL /OVERLAND TIME (ti)				TRAVEL TIME / GUTTER OR CHANNEL FLOW (tt)						tc CHECK (URBANIZED BASIN)		FINAL tc	REMARKS
DESIGN PONIT	SUBBASIN(s) (1)	Area (ac) (2)	C (3)	Length (ft) (4)	Slope (%) (5)	ti (min) (6)	Length (ft) (7)	Slope (%) (8)	n Manning rough. (9)	Vel. (ft/s) (9)	tt (min) (10)	tc = ti + tt (11)	Total L (ft) (12)	tc=(L/180)+10 (min) (13)	(min) (14)	
a	A	1.77	0.55	20	2.0	3.7	650	1.8	0.016	2.7	4.1	7.7	670	13.7	7.7	
b	B	2.85	0.55	50	2.0	5.8	880	1.5	0.022	1.8	8.2	14.0	930	15.2	14.0	
10	OS-10	0.94	0.62	12	2.0	2.4	575	0.6	0.016	1.6	6.2	8.6	587	13.3	8.6	
21	OS-21	0.54	0.65	12	2.0	2.3	225	0.6	0.016	1.6	2.4	4.7	237	11.3	5.0	
10	B+OS-10	3.79	0.57	50	2.0	5.6	1455	1.1	0.020	1.8	13.8	19.4	1505	18.4	18.4	
21	A+OS-21	2.31	0.57	20	2.0	3.5	875	1.5	0.016	2.4	6.0	9.5	895	15.0	9.5	
3	OS-3	0.49	0.58	20	2.0	3.5	600	1.8	0.022	2.0	5.1	8.6	620	13.4	8.6	

EQUATIONS:

$tc = ti + tt$

$ti = [1.87 (1.1 - CC_i) L^{0.5}] / S^{1/3}$

$tt = L/Vel.$

Velocity from Manning's Equation with R=0.1 (corresponds to Figure 3-3 of City of Fort Collins Design Manual)

final tc = minimum of ti + tt and urbanized basin check
 min. tc = 5 min. due to limits of IDF curves

**STANDARD FORM SF-2
TIME OF CONCENTRATION - 100 YR**

LOCATION: Harmony Cottages
 PROJECT NO: 1255-028-00
 COMPUTATIONS BY: es
 DATE: 12/8/2015

100-yr storm Cf = 1.25 from Table RO-12 of City of Fort Collins Stormwater Code, Volume I

SUB-BASIN DATA			INITIAL /OVERLAND TIME (ti)					TRAVEL TIME / GUTTER OR CHANNEL FLOW (tt)						tc CHECK (URBANIZED BASIN)		FINAL tc	REMARKS
DESIGN PONIT	SUBBASIN(s) (1)	Area (ac) (2)	C (3)	C*Cf	Length (ft) (4)	Slope (%) (5)	ti (min) (6)	Length (ft) (7)	Slope (%) (8)	n Manning rough. (9)	Vel. (ft/s) (9)	tt (min) (10)	tc = ti + tt (11)	Total L (ft) (12)	tc=(l/180)+10 (min) (13)	(min) (14)	
a	A	1.77	0.55	0.69	20	2.0	2.7	650	1.8	0.016	2.7	4.1	6.8	670	13.7	6.8	
b	B	2.85	0.55	0.69	50	2.0	4.3	880	1.5	0.022	1.8	8.2	12.5	930	15.2	12.5	
10	OS-10	0.94	0.62	0.78	12	2.0	1.6	575	0.6	0.016	1.6	6.2	7.8	587	13.3	7.8	
21	OS-21	0.54	0.65	0.81	12	2.0	1.5	225	0.6	0.016	1.6	2.4	3.9	237	11.3	5.0	
10	B+OS-10	3.79	0.57	0.71	50	2.0	4.1	1455	1.1	0.020	1.8	13.8	17.9	1505	18.4	17.9	
21	A+OS-21	2.31	0.57	0.72	20	2.0	2.5	875	1.5	0.016	2.4	6.0	8.6	895	15.0	8.6	
3	OS-3	0.49	0.58	0.73	20	2.0	2.5	600	1.8	0.022	2.0	5.1	7.6	620	13.4	7.6	

EQUATIONS:

$tc = ti + tt$

$ti = [1.87 (1.1 - CC_r) L^{0.5}] / S^{1/3}$

$tt = L/Vel.$

Velocity from Manning's Equation with R=0.1 (corresponds to Figure 3-3 of City of Fort Collins Design Manual)

final tc = minimum of ti + tt and urbanized basin check
 min. tc = 5 min. due to limits of IDF curves

**RATIONAL METHOD PEAK RUNOFF
(City of Fort Collins, 2-Yr Storm)**

LOCATION: Harmony Cottages
 PROJECT NO: 1255-028-00
 COMPUTATIONS BY: es
 DATE: 12/8/2015

2 yr storm, Cf = 1.00

Design Point	DIRECT RUNOFF						CARRY OVER		TOTAL	REMARKS
	Tributary Sub-basin	A (ac)	C Cf	tc (min)	i (in/hr)	Q (2) (cfs)	from Design Point	Q (2) (cfs)	Q(2)tot (cfs)	
a	A	1.77	0.55	7.7	2.45	2.4			2.4	WQ Pond
b	B	2.85	0.55	14.0	1.93	3.0			3.0	Rain Garden
10	OS-10	0.94	0.62	8.6	2.36	1.4			1.4	Ex Inlet #10
21	OS-21	0.54	0.65	5.0	2.85	1.0			1.0	Ex Inlet #21
10	B+OS-10	3.79	0.57	18.4	1.69	3.6			3.6	Ex Inlet #10
21	A+OS-21	2.31	0.57	9.5	2.27	3.0			3.0	Ex Inlet #21
3	OS-3	0.49	0.58	8.6	2.36	0.7			0.7	Bioswale

$$Q = C_i C_i A$$

Q = peak discharge (cfs)

C = runoff coefficient

C_i = frequency adjustment factor

i = rainfall intensity (in/hr) from City of Fort Collins IDF curve (4/16/99)

A = drainage area (acres)

$$i = 24.221 / (10 + tc)^{0.7368}$$

**RATIONAL METHOD PEAK RUNOFF
(City of Fort Collins, 10-Yr Storm)**

LOCATION: Harmony Cottages
 PROJECT NO: 1255-028-00
 COMPUTATIONS BY: es
 DATE: 12/8/2015

10 yr storm, Cf = 1.00

Design Point	DIRECT RUNOFF						CARRY OVER		TOTAL	REMARKS
	Tributary Sub-basin	A (ac)	C Cf	tc (min)	i (in/hr)	Q (10) (cfs)	from Design Point	Q (10) (cfs)	Q(10)tot (cfs)	
a	A	1.77	0.55	7.7	4.19	4.1			4.1	WQ Pond
b	B	2.85	0.55	14.0	3.29	5.2			5.2	Rain Garden
10	OS-10	0.94	0.62	8.6	4.03	2.4			2.4	Ex Inlet #10
21	OS-21	0.54	0.65	5.0	4.87	1.7			1.7	Ex Inlet #21
10	B+OS-10	3.79	0.57	18.4	2.88	6.2			6.2	Ex Inlet #10
21	A+OS-21	2.31	0.57	9.5	3.88	5.1			5.1	Ex Inlet #21
3	OS-3	0.49	0.58	8.6	4.04	1.2			1.2	Bioswale

$$Q = C_f C_i A$$

Q = peak discharge (cfs)

C = runoff coefficient

C_f = frequency adjustment factor

i = rainfall intensity (in/hr) from City of Fort Collins IDF curve (4/16/99)

A = drainage area (acres)

$$i = 41.44 / (10 + tc)^{0.7874}$$

**RATIONAL METHOD PEAK RUNOFF
(City of Fort Collins, 100-Yr Storm)**

LOCATION: Harmony Cottages
 PROJECT NO: 1255-028-00
 COMPUTATIONS BY: es
 DATE: 12/8/2015

100 yr storm, Cf = 1.25

		DIRECT RUNOFF					CARRY OVER		TOTAL	REMARKS
Des. Point	Area Design.	A (ac)	C Cf	tc (min)	i (in/hr)	Q (100) (cfs)	from Design Point	Q (100) (cfs)	Q(100)tot (cfs)	
a	A	1.77	0.69	6.8	8.92	10.9			10.9	WQ Pond
b	B	2.85	0.69	12.5	7.06	13.8			13.8	Rain Garden
10	OS-10	0.94	0.78	7.8	8.52	6.3			6.3	Ex Inlet #10
21	OS-21	0.54	0.81	5.0	9.95	4.3			4.3	Ex Inlet #21
10	B+OS-10	3.79	0.71	17.9	5.95	16.0			16.0	Ex Inlet #10
21	A+OS-21	2.31	0.72	8.6	8.24	13.6			13.6	Ex Inlet #21
3	OS-3	0.49	0.73	7.6	9.95	3.6			3.6	Bioswale

$Q = CiA$

Q = peak discharge (cfs)
 C = runoff coefficient
 i = rainfall intensity (in/hr) from City of Fort Collins IDF curve (4/16/99)
 A = drainage area (acres) $i = 84.682 / (10 + tc)^{0.7975}$

SUMMARY

DRAINAGE SUMMARY TABLE

Design Point	Tributary Sub-basin	Area (ac)	C (10)	C (100)	tc (10) (min)	tc (100) (min)	Q(2)tot (cfs)	Q(10)tot (cfs)	Q(100)tot (cfs)	REMARKS
a	A	1.77	0.55	0.69	7.7	6.8	2.4	4.1	10.9	WQ Pond
b	B	2.85	0.55	0.69	14.0	12.5	3.0	5.2	13.8	Rain Garden
10	OS-10	0.94	0.62	0.78	8.6	7.8	1.4	2.4	6.3	Ex Inlet #10
21	OS-21	0.54	0.65	0.81	5.0	5.0	1.0	1.7	4.3	Ex Inlet #21
3	OS-3	0.49	0.58	0.73	8.6	7.6	0.7	1.2	3.6	Bioswale

Table RO-3—Recommended Percentage Imperviousness Values

Land Use or Surface Characteristics	Percentage Imperviousness
Business:	
Commercial areas	95
Neighborhood areas	85
Residential:	
Single-family	*
Multi-unit (detached)	60
Multi-unit (attached)	75
Half-acre lot or larger	*
Apartments	80
Industrial:	
Light areas	80
Heavy areas	90
Parks, cemeteries	5
Playgrounds	10
Schools	50
Railroad yard areas	15
Undeveloped Areas:	
Historic flow analysis	2
Greenbelts, agricultural	2
Off-site flow analysis (when land use not defined)	45
Streets:	
Paved	100
Gravel (packed)	40
Drive and walks	90
Roofs	90
Lawns, sandy soil	0
Lawns, clayey soil	0

* See [Figures RO-3](#) through [RO-5](#) for percentage imperviousness.

$$C_A = K_A + (1.31i^3 - 1.44i^2 + 1.135i - 0.12) \text{ for } C_A \geq 0, \text{ otherwise } C_A = 0 \quad (\text{RO-6})$$

$$C_{CD} = K_{CD} + (0.858i^3 - 0.786i^2 + 0.774i + 0.04) \quad (\text{RO-7})$$

$$C_B = (C_A + C_{CD})/2$$

(b) For a Project Plan or Final Plan submittal, runoff coefficients based on the proposed land surface types must be used. Since the actual runoff coefficients may be different from those specified in Table RO-10, Table RO-11 lists coefficients for the different types of land surfaces. The runoff coefficient used for design must be based on the actual conditions of the proposed site.

**Table RO-10
Rational Method Minor Storm Runoff Coefficients for Zoning Classifications**

<i>Description of Area or Zoning</i>	<i>Coefficient</i>
R-F	0.3
U-E	0.3
L-M-In	0.55
R-L, N-C-L	0.6
M-M-N, N-C-M	0.65
N-C-B	0.7
Business:	
C-C-N, C-C-R, C-N, N-C, C-S	0.95
R-D-R, C-C, C-L	0.95
D, C	0.95
H-C	0.95
C-S	0.95
Industrial:	
E	0.85
I	0.95
Undeveloped:	
R-C, T	0.2
P-O-L	0.25

For guidance regarding zoning districts and classifications of such districts please refer to Article Four of the City Land Use Code, as amended.

**Table RO-11
Rational Method Runoff Coefficients for Composite Analysis**

<i>Character of Surface</i>	<i>Runoff Coefficient</i>
Streets, parking lots, drives:	
Asphalt	0.95
Concrete	0.95
Gravel	0.5
Roofs	0.95
Recycled asphalt	0.8
Lawns, sandy soil:	
Flat <2%	0.1
Average 2 to 7%	0.15
Steep >7%	0.2
Lawns, heavy soil:	
Flat <2%	0.2
Average 2 to 7%	0.25
Steep >7%	0.35

(4) A new *Section 2.9* is added, to read as follows:

APPENDIX C

**HYDRAULIC CALCULATIONS
(PROVIDED AT FINAL)**

APPENDIX D

**STORMWATER DETENTION POND
ANALYSIS**

RATIONAL METHOD PEAK RUNOFF
(City of Fort Collins, 100-Yr Storm - OLD rainfall)

LOCATION: **Harmony Cottages**
 PROJECT NO: 1255-028-00
 COMPUTATIONS BY: es
 DATE: 12/5/2015

100 yr storm, Cf = 1.25

		DIRECT RUNOFF					CARRY OVER		TOTAL	REMARKS
Des.	Area	A	C Cf	tc	i	Q (100)	from	Q (100)	Q(100)tot	
Point	Design.	(ac)		(min)	(in/hr)	(cfs)	Design	(cfs)	(cfs)	
							Point			
1	site	4.45	1.00	5.00	9.00	40.05			40.1	Allowable release under old rainfall conditions

$Q = C i A$

Q = peak discharge (cfs)
 C = runoff coefficient
 i = rainfall intensity (in/hr) from OLD City of Fort Collins IDF curve
 A = drainage area (acres)

OLD CITY OF FORT COLLINS IDF DATA

INTERPOLATED VALUES FOR 100 YEAR INTENSITIES

Tc	Value (IN./HR.)
5.00	9.0
5.10	9.0
5.20	8.9
5.30	8.9
5.40	8.9
5.50	8.8
5.60	8.8
5.70	8.7
5.80	8.7
5.90	8.7
6.00	8.6
6.10	8.6
6.20	8.6
6.30	8.5
6.40	8.5
6.50	8.5
6.60	8.4
6.70	8.4
6.80	8.4
6.90	8.3
7.00	8.3
7.10	8.2
7.20	8.2
7.30	8.2
7.40	8.1
7.50	8.1
7.60	8.1
7.70	8.0
7.80	8.0
7.90	8.0
8.00	7.9
8.10	7.9
8.20	7.8
8.30	7.8
8.40	7.8
8.50	7.7
8.60	7.7
8.70	7.7
8.80	7.6
8.90	7.6
9.00	7.6
9.10	7.5
9.20	7.5
9.30	7.5
9.40	7.4
9.50	7.4
9.60	7.3
9.70	7.3
9.80	7.3
9.90	7.2
10.00	7.2

DETENTION VOLUME CALCULATIONS
Rational Volumetric (FAA) Method
100-Year Event

LOCATION: **Harmony Cottages**
PROJECT NO: 1255-028-00
COMPUTATIONS BY: es
DATE: 12/5/15

Equations:

Developed flow = $Q_D = CIA$	Area trib. to pond =	4.45	acre
Vol. In = $V_i = T C I A = T Q_D$	C (100) =	0.70	
Vol. Out = $V_o = K Q_{PO} T$	Developed C A =	3.1	acre - site only
storage = $S = V_i - V_o$	Release rate, Q_{PO} =	40.1	cfs
	K =	0.9	(from fig 2.1)

Rainfall intensity from City of Fort Collins IDF Curve with updated (3.67") rainfall

Storm Duration, T (min)	Rainfall Intensity, I (in/hr)	Q_D (cfs)	Vol. In V_i (ft ³)	Vol. Out V_o (ft ³)	Storage S (ft ³)	Storage S (ac-ft)
5	9.95	31.0	9298	10814	-1515	-0.03
10	7.77	24.2	14515	21627	-7112	-0.16
20	5.62	17.5	21010	43254	-22244	-0.51
30	4.47	13.9	25054	64881	-39827	-0.91
40	3.74	11.6	27960	86508	-58548	-1.34
50	3.23	10.1	30220	108135	-77915	-1.79
60	2.86	8.9	32069	129762	-97693	-2.24
70	2.57	8.0	33634	151389	-117755	-2.70
80	2.34	7.3	34993	173016	-138023	-3.17
90	2.15	6.7	36195	194643	-158448	-3.64
100	1.99	6.2	37273	216270	-178997	-4.11
110	1.86	5.8	38251	237897	-199646	-4.58
120	1.75	5.4	39148	259524	-220376	-5.06
130	1.65	5.1	39977	281151	-241174	-5.54
140	1.56	4.9	40747	302778	-262031	-6.02
150	1.48	4.6	41467	324405	-282938	-6.50
160	1.41	4.4	42144	346032	-303888	-6.98
170	1.35	4.2	42783	367659	-324876	-7.46
180	1.29	4.0	43388	389286	-345898	-7.94

Required Storage Volume:	-1515	ft³	
	-0.03	acre-ft	

APPENDIX E

**WATER QUALITY
AND
LID INFORMATION**

Design Procedure Form: Rain Garden (RG)

Sheet 1 of 2

Designer: sb
Company: Interwest Consulting Group
Date: January 19, 2016
Project: Harmony Cottages
Location: Basin A

<p>1. Basin Storage Volume</p> <p>A) Effective Imperviousness of Tributary Area, I_a (100% if all paved and roofed areas upstream of rain garden)</p> <p>B) Tributary Area's Imperviousness Ratio ($i = I_a/100$)</p> <p>C) Water Quality Capture Volume (WQCV) for a 12-hour Drain Time ($WQCV = 0.8 * (0.91 * I^3 - 1.19 * I^2 + 0.78 * I)$)</p> <p>D) Contributing Watershed Area (including rain garden area)</p> <p>E) Water Quality Capture Volume (WQCV) Design Volume Vol = (WQCV / 12) * Area</p> <p>F) For Watersheds Outside of the Denver Region, Depth of Average Runoff Producing Storm</p> <p>G) For Watersheds Outside of the Denver Region, Water Quality Capture Volume (WQCV) Design Volume</p> <p>H) User Input of Water Quality Capture Volume (WQCV) Design Volume (Only if a different WQCV Design Volume is desired)</p>	<p>$I_a =$ <u>50.0</u> %</p> <p>$i =$ <u>0.500</u></p> <p>WQCV = <u>0.17</u> watershed inches</p> <p>Area = <u>77,160</u> sq ft</p> <p>$V_{WQCV} =$ <u>1,061</u> cu ft</p> <p>$d_6 =$ _____ in</p> <p>$V_{WQCV\ OTHER} =$ _____ cu ft</p> <p>$V_{WQCV\ USER} =$ _____ cu ft</p>
<p>2. Basin Geometry</p> <p>A) WQCV Depth (12-inch maximum)</p> <p>B) Rain Garden Side Slopes ($Z = 4$ min., horiz. dist per unit vertical) (Use "0" if rain garden has vertical walls)</p> <p>C) Minimum Flat Surface Area</p> <p>D) Actual Flat Surface Area</p> <p>E) Area at Design Depth (Top Surface Area)</p> <p>F) Rain Garden Total Volume ($V_T = ((A_{Top} + A_{Actual}) / 2) * Depth$)</p>	<p>$D_{WQCV} =$ <u>12</u> in</p> <p>$Z =$ <u>4.00</u> ft / ft</p> <p>$A_{Min} =$ <u>707</u> sq ft</p> <p>$A_{Actual} =$ <u>725</u> sq ft</p> <p>$A_{Top} =$ <u>1400</u> sq ft</p> <p>$V_T =$ <u>1,063</u> cu ft</p>
<p>3. Growing Media</p>	<p>Choose One _____</p> <p><input type="radio"/> 18" Rain Garden Growing Media</p> <p><input checked="" type="radio"/> Other (Explain): <u>Standard City of Fort Collins Spec</u></p>
<p>4. Underdrain System</p> <p>A) Are underdrains provided?</p> <p>B) Underdrain system orifice diameter for 12 hour drain time</p> <p style="margin-left: 20px;">i) Distance From Lowest Elevation of the Storage Volume to the Center of the Orifice</p> <p style="margin-left: 20px;">ii) Volume to Drain in 12 Hours</p> <p style="margin-left: 20px;">iii) Orifice Diameter, 3/8" Minimum</p>	<p>Choose One _____</p> <p><input checked="" type="radio"/> YES</p> <p><input type="radio"/> NO</p> <p>$y =$ _____ ft</p> <p>$Vol_{12} =$ <u>N/A</u> cu ft</p> <p>$D_o =$ <u>N/A</u> in</p>

Design Procedure Form: Rain Garden (RG)

Sheet 2 of 2

Designer: sb
Company: Interwest Consulting Group
Date: January 19, 2016
Project: Harmony Cottages
Location: Basin A

5. Impermeable Geomembrane Liner and Geotextile Separator Fabric

A) Is an impermeable liner provided due to proximity of structures or groundwater contamination?

Choose One _____
 YES
 NO

6. Inlet / Outlet Control

A) Inlet Control

Choose One _____
 Sheet Flow- No Energy Dissipation Required
 Concentrated Flow- Energy Dissipation Provided

7. Vegetation

Choose One _____
 Seed (Plan for frequent weed control)
 Plantings
 Sand Grown or Other High Infiltration Sod

8. Irrigation

A) Will the rain garden be irrigated?

Choose One _____
 YES
 NO

Notes: _____

Design Procedure Form: Rain Garden (RG)

Sheet 1 of 2

Designer: sb
Company: Interwest Consulting Group
Date: January 19, 2016
Project: Harmony Cottages
Location: Basin B

<p>1. Basin Storage Volume</p> <p>A) Effective Imperviousness of Tributary Area, I_a (100% if all paved and roofed areas upstream of rain garden)</p> <p>B) Tributary Area's Imperviousness Ratio ($i = I_a/100$)</p> <p>C) Water Quality Capture Volume (WQCV) for a 12-hour Drain Time ($WQCV = 0.8 * (0.91 * I_a^3 - 1.19 * I_a^2 + 0.78 * I_a)$)</p> <p>D) Contributing Watershed Area (including rain garden area)</p> <p>E) Water Quality Capture Volume (WQCV) Design Volume Vol = (WQCV / 12) * Area</p> <p>F) For Watersheds Outside of the Denver Region, Depth of Average Runoff Producing Storm</p> <p>G) For Watersheds Outside of the Denver Region, Water Quality Capture Volume (WQCV) Design Volume</p> <p>H) User Input of Water Quality Capture Volume (WQCV) Design Volume (Only if a different WQCV Design Volume is desired)</p>	<p>$I_a =$ <u>50.0</u> %</p> <p>$i =$ <u>0.500</u></p> <p>WQCV = <u>0.17</u> watershed inches</p> <p>Area = <u>124,007</u> sq ft</p> <p>$V_{WQCV} =$ <u>1,705</u> cu ft</p> <p>$d_6 =$ _____ in</p> <p>$V_{WQCV\ OTHER} =$ _____ cu ft</p> <p>$V_{WQCV\ USER} =$ _____ cu ft</p>
<p>2. Basin Geometry</p> <p>A) WQCV Depth (12-inch maximum)</p> <p>B) Rain Garden Side Slopes ($Z = 4$ min., horiz. dist per unit vertical) (Use "0" if rain garden has vertical walls)</p> <p>C) Minimum Flat Surface Area</p> <p>D) Actual Flat Surface Area</p> <p>E) Area at Design Depth (Top Surface Area)</p> <p>F) Rain Garden Total Volume ($V_T = ((A_{Top} + A_{Actual}) / 2) * Depth$)</p>	<p>$D_{WQCV} =$ <u>12</u> in</p> <p>$Z =$ <u>4.00</u> ft / ft</p> <p>$A_{Min} =$ <u>1137</u> sq ft</p> <p>$A_{Actual} =$ <u>1465</u> sq ft</p> <p>$A_{Top} =$ <u>2567</u> sq ft</p> <p>$V_T =$ <u>2,016</u> cu ft</p>
<p>3. Growing Media</p>	<p>Choose One _____</p> <p><input type="radio"/> 18" Rain Garden Growing Media</p> <p><input checked="" type="radio"/> Other (Explain): <u>Standard City of Fort Collins Spec</u></p>
<p>4. Underdrain System</p> <p>A) Are underdrains provided?</p> <p>B) Underdrain system orifice diameter for 12 hour drain time</p> <p style="margin-left: 20px;">i) Distance From Lowest Elevation of the Storage Volume to the Center of the Orifice</p> <p style="margin-left: 20px;">ii) Volume to Drain in 12 Hours</p> <p style="margin-left: 20px;">iii) Orifice Diameter, 3/8" Minimum</p>	<p>Choose One _____</p> <p><input checked="" type="radio"/> YES</p> <p><input type="radio"/> NO</p> <p>$y =$ _____ ft</p> <p>$Vol_{12} =$ <u>N/A</u> cu ft</p> <p>$D_o =$ <u>N/A</u> in</p>

Design Procedure Form: Rain Garden (RG)

Sheet 2 of 2

Designer: sb
Company: Interwest Consulting Group
Date: January 19, 2016
Project: Harmony Cottages
Location: Basin B

<p>5. Impermeable Geomembrane Liner and Geotextile Separator Fabric</p> <p>A) Is an impermeable liner provided due to proximity of structures or groundwater contamination?</p>	<p>Choose One _____</p> <p><input type="radio"/> YES</p> <p><input checked="" type="radio"/> NO</p>
<p>6. Inlet / Outlet Control</p> <p>A) Inlet Control</p>	<p>Choose One _____</p> <p><input type="radio"/> Sheet Flow- No Energy Dissipation Required</p> <p><input checked="" type="radio"/> Concentrated Flow- Energy Dissipation Provided</p>
<p>7. Vegetation</p>	<p>Choose One _____</p> <p><input type="radio"/> Seed (Plan for frequent weed control)</p> <p><input checked="" type="radio"/> Plantings</p> <p><input type="radio"/> Sand Grown or Other High Infiltration Sod</p>
<p>8. Irrigation</p> <p>A) Will the rain garden be irrigated?</p>	<p>Choose One _____</p> <p><input type="radio"/> YES</p> <p><input type="radio"/> NO</p>
<p>Notes: _____</p> <p>_____</p> <p>_____</p> <p>_____</p>	

Harmony Cottages

LID Table

50% On-Site Treatment by LID Requirement	
New Impervious Area	110,940 sq. ft.
Required Minimum Impervious Area to be Treated	55,470 sq. ft.
Area Treated by Pavers	57,808 sq. ft.
Area Treated by Rain Garden A	35,370 sq. ft.
Area Treated Rain Garden B	70,426 sq. ft.
Total Impervious Area Treated	163,604 sq. ft.
Actual % On-Site Treated by LID	147 %
25% Porous Pavement Requirement	
New Pavement Area	27,679 sq. ft.
Required Minimum Area of Porous Pavement	6,920 sq. ft.
Area of Paver Section	7,427 sq. ft.
Total Porous Pavement Area	7,427 sq. ft.
Actual % of Porous Pavement Provided	27 %

Harmony Cottages

LID Table

75% On-Site Treatment by LID Requirement	
New Impervious Area	110,940 sq. ft.
Required Minimum Impervious Area to be Treated	83,205 sq. ft.
Area Treated by Rain Garden A	35,370 sq. ft.
Area Treated by Rain Garden B	70,426 sq. ft.
Total Impervious Area Treated	105,796 sq. ft.
Actual % On-Site Treated by LID	95 %

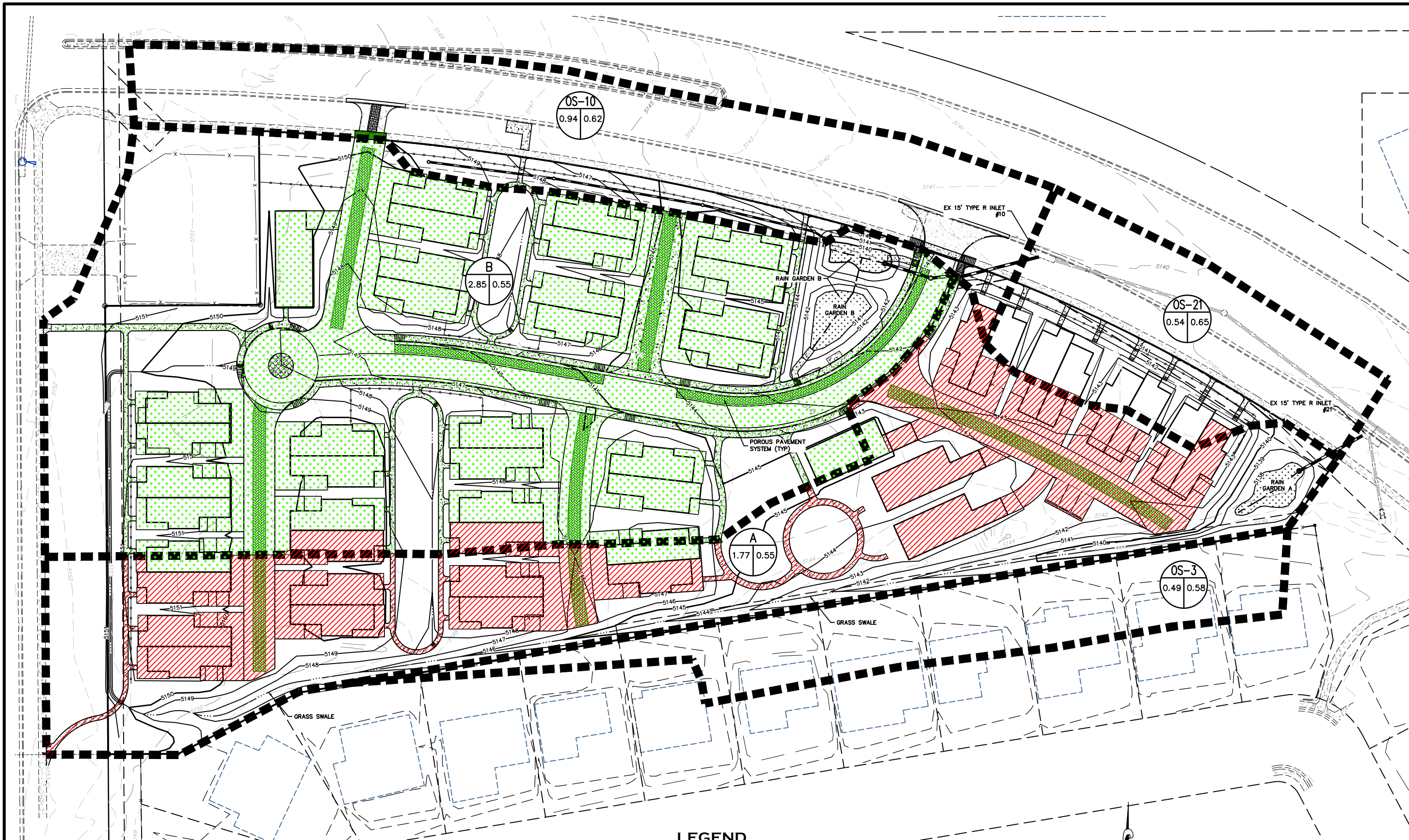

Harmony Cottages LID Table	
75% On-Site Treatment by LID Requirement	
New Impervious Area	110,940 sq. ft.
Required Minimum Impervious Area to be Treated	83,205 sq. ft.
Area Treated by Rain Garden A	35,370 sq. ft.
Area Treated by Rain Garden B	70,426 sq. ft.
Total Impervious Area Treated	105,796 sq. ft.
Actual % On-Site Treated by LID	95 %

LEGEND

- IMPERVIOUS AREA TREATED BY RAIN GARDEN A (35,370 SF, 32% OF TOTAL IMP. AREA)
- IMPERVIOUS AREA TREATED BY RAIN GARDEN B (70,426 SF, 63% OF TOTAL IMP. AREA)

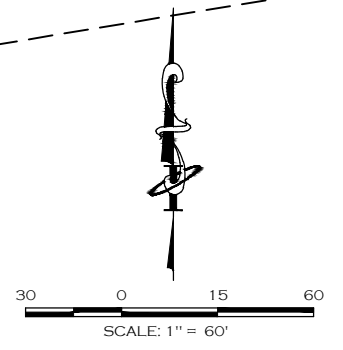

CALL UTILITY NOTIFICATION
 CENTER OF COLORADO
811
 CALL 2-BUSINESS DAYS IN ADVANCE
 BEFORE YOU DIG, GRADE, OR EXCAVATE
 FOR THE MARKING OF UNDERGROUND
 MEMBER UTILITIES.

\P:\PROJECTS\2015\PROJECTS\1255-028-00\HARMONY_COTTAGES\LID_EXHIBIT.dwg 02/05/2016 10:00 AM 1/17/2016 10:00 AM

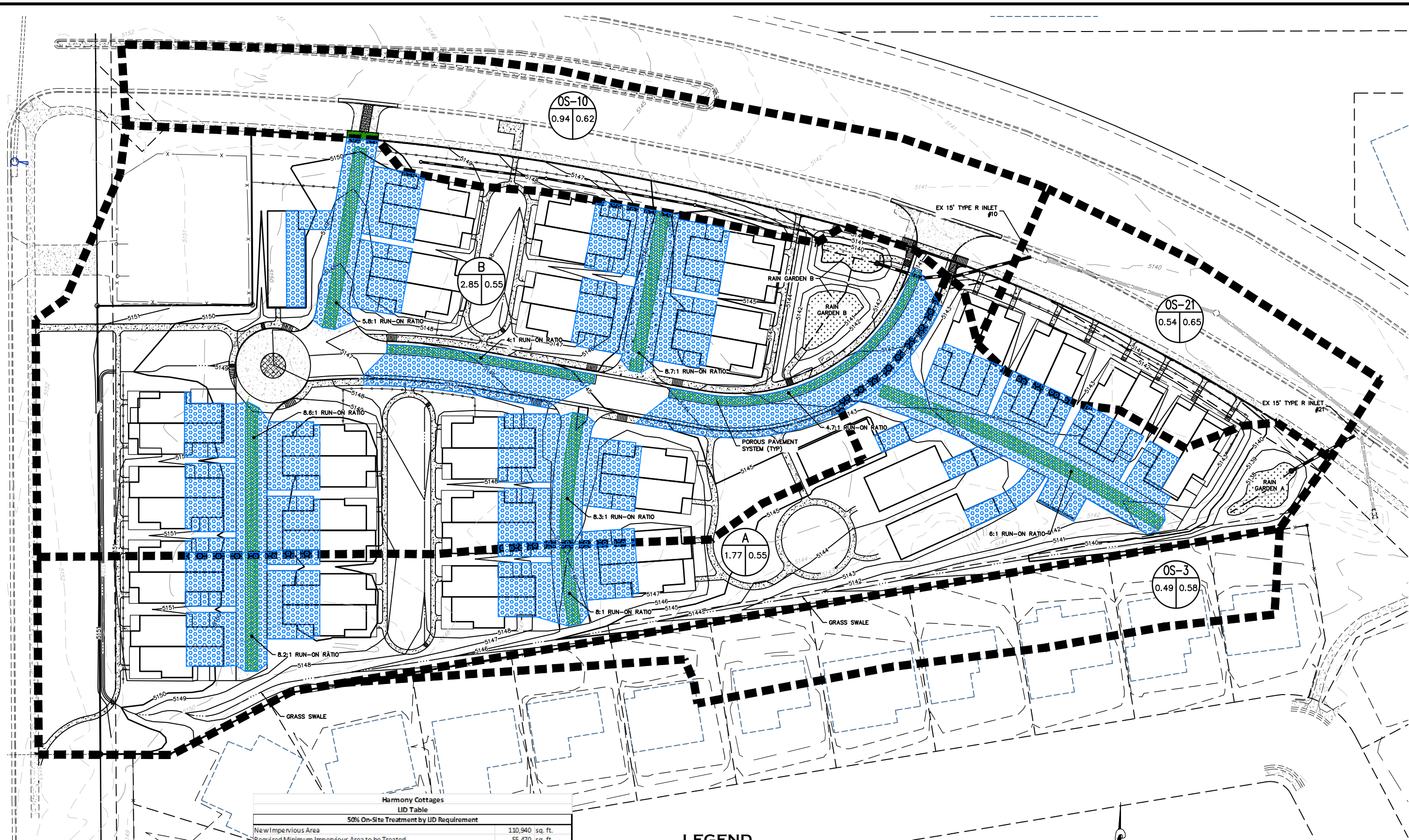

Harmony Cottages
LID Table

50% On-Site Treatment by LID Requirement	
New Impervious Area	110,940 sq. ft.
Required Minimum Impervious Area to be Treated	55,470 sq. ft.
Area Treated by Pavers	24,994 sq. ft.
Area Treated by Rain Garden A	35,370 sq. ft.
Area Treated Rain Garden B	70,426 sq. ft.
Total Impervious Area Treated	130,790 sq. ft.
Actual % On-Site Treated by LID	118 %
25% Porous Pavement Requirement	
New Pavement Area	27,679 sq. ft.
Required Minimum Area of Porous Pavement	6,920 sq. ft.
Area of Paver Section	7,427 sq. ft.
Total Porous Pavement Area	7,427 sq. ft.
Actual % of Porous Pavement Provided	27 %

LEGEND



AREA TREATED BY
 POROUS PAVEMENT LID
 (57,808 SF, 52%)

NOTE: AVERAGE RUN-ON AREA IS 8:1 WHICH EXCEEDS
 RECOMMENDED 3:1 MAXIMUM. RUNOFF WILL BE
 TREATED A SECOND TIME BY THE DOWNSTREAM
 RAIN GARDENS.

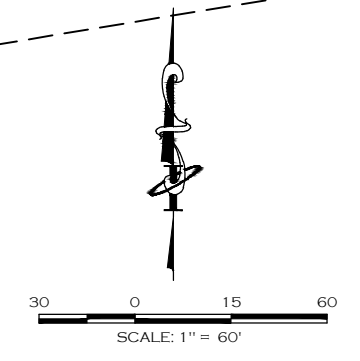

CALL UTILITY NOTIFICATION
 CENTER OF COLORADO
811
 CALL 2-BUSINESS DAYS IN ADVANCE
 BEFORE YOU DIG, GRADE, OR EXCAVATE
 FOR THE MARKING OF UNDERGROUND
 MEMBER UTILITIES.

\P:\PROJECTS\2015\PROJECTS\2015-01-01-01\HARMONY_COTTAGES\LID-01-01-01.dwg (1/20/16 8:17 AM)

APPENDIX F

EXCERPTS FROM REFERENCE REPORTS

MAIL CREEK BASIN MASTER DRAINAGE PLAN

HYDROLOGY TECHNICAL APPENDIX

PREPARED FOR:

**City of Fort Collins Utilities
700 Wood Street
Fort Collins, CO 80521**

PREPARED BY:

**Sear-Brown
209 South Meldrum
Fort Collins, CO 80521**

April 22, 2002

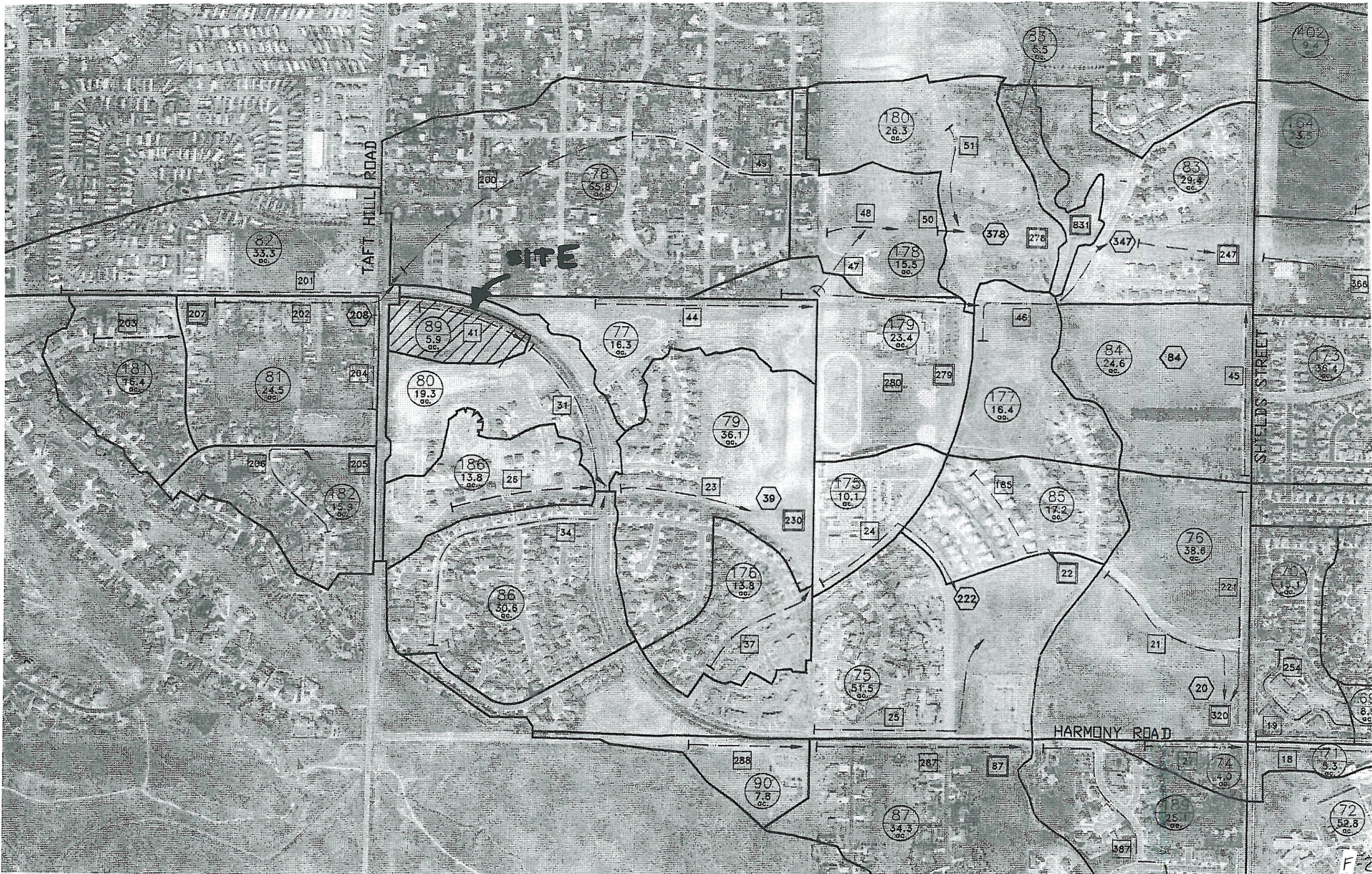

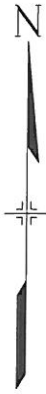

HARMONY Cottages

c:\Documents and Settings\vechneider\Local Settings\Temporary Internet Files\OLK9g\ManhattanSubbasinMap.dwg May 23, 2007 - 3:43pm

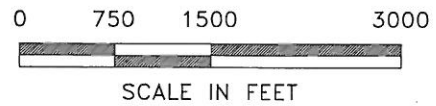

SCALE IN FEET

URS 1225 17TH STREET SUITE 200 DENVER, CO 80202
Tel: 303-293-8080, Fax: 303-299-8711

FOR AND ON BEHALF OF URS, INC.

CITY OF FORT COLLINS
MAIL CREEK BASIN
SUB-BASIN DIAGRAM
FIGURE E-2

DESIGNED BY: PVR	SCALE:	DATE ISSUED: 11/07/02
DRAWN BY: CLM	HORIZ.:	SHEET NO. 1 OF 1 SHEETS
CHECKED BY: PVR	VERT.:	

MHP-176.cts.in

2 1 1 2
3 4
WATERSHED
Manhattan Pond Final Design (176cfs Tailwater) - MAIL CREEK BASIN, 100-YEAR STORM, DEVELOPED CONDITIONS 2002
REVISED 31, March, 2005 ICON ENGINEERING

1 1000 000 5. 1 1.
24 5.
1.0 1.14 1.33 2.23 2.84 5.49 9.95 4.12 2.48 1.46
1.06 1.0 .95 .91 .87 .84 .81 .78 .75
.71 .69 .67

* Prepared for: City of Fort Collins
* SWMM developed condition, existing facilities, 100-yr recurrence interval

*
-2
1 51 104309. 87.1 30.7 .040
1 151 1506675.58.23 30.0 .023
1 52 113717. 38.4 17.0 .064
1 53 2113630. 35.0 24.5 .032
1 153 1526377.46.85 35.0 .014
1 54 142895. 18.6 95.0 .048
1 55 2612150. 12.8 95.0 .016
1 56 567665. 93.3 95.0 .016
1 57 571908. 12.7 95.0.0088
1 120 1204538. 37.5 95.0.0088
1 121 1216757. 60.5 95.0.0088
1 122 1222659. 17.7 95.0.0088
1 58 1112242. 29.3 28.9 .032
1 59 161214. 9.2 30.0.0134
1 159 331725. 6.3 83.3 .01
1 60 357608. 57.6 35.0 .016
1 61 422308. 19.6 30.0 .016
1 62 386572. 47.4 37.6 .016
1 162 3622465. 27.2 42.0 .015
1 163 3791498. 4.29 80.0 .010
1 401 3671863. 0.63100.0 .015
1 63 9002763. 18.2 95.0 .010
1 165 3654581. 29.4 37.0 .016
1 166 3664325. 27.8 47.8 .01
1 167 3673647. 17.6 37.0 .01
1 168 3681188. 6.0 95.0 .01
1 169 3681836. 1.3100.0 .02
1 170 3703640. 33.4 36.5 .01
1 171 3712315. 23.4 47.8 .01
1 172 3722304. 4.2 72.4 .01
1 173 3734663. 36.4 32.0 .01
1 164 3642093. 23.5 65.3 .01
402 4122594. 9.43 80.0 .01
403 4321241. 0.76100.0 .015
65 2103960. 20.0 37.6 .064
1 67 367462. 39.4 36.0.0088
1 68 326758. 54.3 32.0 .016
1 69 3182756. 8.9 49.8 .011
1 70 2543289. 15.1 53.9 .016
1 71 181536. 5.3 36.7.0143
1 72 6015055. 44.1 60.0 .020
1 801 139 997. 8.7 5.0 .020
1 73 292908. 20.0 35.0 .035
1 74 27 543. 4.0 35.0.0104
1 75 255341. 51.5 45.3.0134
1 175 243143. 10.1 50.0 .015
1 76 2214804. 38.6 38.0 .016
1 176 374011. 13.8 53.5 .019
1 77 441780. 16.3 35.0 .012
1 177 462043. 16.4 38.0 .02
1 78 4910616 65.8 25.0 .016

* WESTFIELD PARK
1 178 481276. 15.5 25.0 .035
1 79 395615. 36.1 35.0 .019
1 179 2803390. 23.4 50.0 .020
1 80 314208. 19.3 35.0 .032
1 186 263004. 13.8 35.0 .032
1 81 2042482. 24.5 30.0 .016
1 181 2033570. 16.4 30.0 .016
1 182 2063144. 15.9 35.0 .016
1 82 2013022. 33.3 59.9.0091

* DIVIDE BASIN 83 TO REFLECT FLOW TO POND 831
1 83 3477115. 29.4 35.0 .02
1 831 8311711. 5.5 35.0 .02
1 84 843065. 24.6 38.0.0072
1 85 1852138. 17.2 38.0 .016
1 86 345330. 30.6 40.0 .032
1 87 2871938. 34.5 23.0 .02
1 88 28 813. 8.0 23.0.0154
1 89 411283. 5.9 95.0.032
1 180 514243. 26.3 38.0 .012
90 288 788. 7.8 23.0 .020
189 3873647. 25.1 35.0 .013

Assumed 95% I

0
1 1
62
10 1 0 1 10.0 3400. .011 4.0 4.0 .044 12.0
150 10 0 1 48.0 1850. .015 50.0 50.0 .020 5.0
11 10 0 1 10.0 1900. .013 2.5 2.5 .060 16.0
12 210 0 1 10.0 1000. .011 2.0 2.0 .060 12.0

**FINAL DRAINAGE AND
EROSION CONTROL STUDY FOR
THE OVERLOOK AT WOODRIDGE
FOURTH FILING PHASE ONE
FORT COLLINS, COLORADO**

June 14, 1995

Prepared for:

Woodcraft Homes
3665 JFK Parkway
Building 1, Suite 300
Fort Collins, Colorado 80525-3153

Prepared by:

RBD, Inc. Engineering Consultants
209 South Meldrum
Fort Collins, Colorado 80521
(303) 482-5922

RBD Job No. 434-011

**FINAL DRAINAGE AND
EROSION CONTROL STUDY
FOR THE OVERLOOK AT WOODRIDGE
FOURTH FILING PHASE ONE
FORT COLLINS, COLORADO**

I. GENERAL LOCATION AND DESCRIPTION

A. Location

The Overlook at Woodridge Fourth Filing P.U.D. is bounded by Taft Hill Road (County Road 19) on the west, Imperial Estates on the north, future Harmony Road and The Gates Fourth Filing to the east, and by the Overlook Third Filing on the south.

The site location can also be described as situated in the Southwest 1/4 of Section 34, Township 7 North, Range 69 West of the 6th P.M., City of Fort Collins, Larimer County, Colorado. The site location can be seen on Exhibit 1 in the Appendix.

B. Description of Property

The Fourth Filing of the Overlook at Woodridge contains approximately 32.8 acres, more or less. Presently, the property is undeveloped. The property is being proposed for planned unit development within the City of Fort Collins Zoning District and will be developed consistent with the Overlook First through Third Filings at Woodridge. Native grasses presently cover the property. The topography of the site generally slopes from west to east at approximately 1.5 percent.

II. DRAINAGE BASINS

A. Major Basin Description

The majority of the proposed development lies within Basin 80 (see SWMM portion of Appendix) of the McClellands and Mail Creek Major Drainageway Plan prepared by Cornell Consulting Company. A natural drainageway runs from west to east along the southern edge of the project boundary within Basin 80. Runoff from Basin 80 is routed by open channels and culverts along the northern boundary of the Gates First, Second and Third Filings, along the north side of Seneca Street past Webber Junior High School, and then along the east side of

Regency Drive to the existing Regional Detention Pond. This development will also include improvements to a portion of the existing Taft Hill Road, although these off-site improvements are not seeking Phase One approval.

B. Sub-basin Description

The Overlook Fourth Filing has been divided into 15 sub-basins. Fourteen (14) of these basins will drain to Basin 80 of the McClellands and Mail Creek Master Plan, while the remaining Basin O-2 drains into the historic Basin 77 of the McClellands and Mail Creek Master Plan. Except for the off-street portions of Basins 1 and 2A, all 15 basins will be developed consisting of proposed residential housing and street improvements, including improvements to Taft Hill Road and to Harmony Road. Basins 1 and 2A will be developed as neighborhood commercial sites at a later time. These sub-basins are shown on the Drainage and Erosion Control Plan in the back pocket of this report. ←

C. SWMM Revisions

The portion of the City of Fort Collins' SWMM model for a 100-year storm event within the Mail Creek Basin--tributary to Seneca Street (conveyance element 24)--was updated to reflect field conditions, phasing, and proposed storm drainage system modifications.

Basins 75, 77 through 80, 86, 175, 176, 179, and 186 were added or updated to account for the presently developed Woodridge subdivisions (Overlook and Gates First through Third Filings) and the proposed Overlook Fourth Filing Phase One subdivision. Conveyance elements 23, 26, 31, 34, 37, 44, 47, 49, and 230 were also added or updated to be consistent with present and proposed conditions.

III. DRAINAGE DESIGN CRITERIA

A. Regulations

The City of Fort Collins Storm Drainage Design Criteria is being used for the subject site.

B. Development Criteria Reference and Constraints

The 1990 Preliminary Drainage Report for Webber Junior High School states that the channel and culvert system along the north side of Seneca Street and the east side of Regency Drive was sized for undetained off-site 100 year developed runoff from Basins 79, 80, and 85. Recent SWMM analysis for Basins 79 and 80, by the City of Fort Collins, has determined that the existing channel, culverts and Seneca Street (downstream of the subject site) will receive greater 100-year

The proposed drainage, erosion control, and grading plans are included in the back pocket of this report.

B. Specific Details

The Overlook at Woodridge has been broken down into 15 sub-basins. The sub-basin designations correspond to the basin designations of the Preliminary/Master Drainage Study for the Woodridge development. Specific details of off-site basins will be addressed again in the final report for the entire Overlook Fourth Filing development.

Runoff from sub-basins 1, 2A, 2B, 3A, 3B, 3C, 12, and 13 will be conveyed easterly towards Harmony Road by a combination of gutter flows and a storm drain system. At Harmony Road, developed runoff will be conveyed via storm drains within the Harmony Road alignment to the Woodridge regional channel. Inlets at the low point of Harmony Road (D.P. 120 and D.P. 130) intercept the remaining street flow from the above basins, as well as remaining street flow from the Overlook and Gates Third Filings. The storm drains will daylight in the regional channel downstream of the Harmony Road crossing.

To complete the storm drain design from the Overlook Third Filing Final Drainage and Erosion Control Study, a curb inlet will be constructed within the Third Filing at the northwest corner of the Harmony Road and Silvergate Road intersection. A curb inlet will be required at this point (D.P. 11) as curb and gutter flows exceed City criteria. Third Filing storm drain flows will be piped from this inlet across Harmony Road to the regional channel.

Runoff from sub-basins 4A, 4B, and 4C will be conveyed to the regional channel by a combination of gutter flows and a short storm drain system (using 21- and 30-inch pipe). This storm drain will daylight in the regional channel immediately upstream of the Harmony Road crossing (D.P. 55).

Runoff from sub-basins 5A, 5B, and 5C is primarily generated within the most upstream portion of the regional channel itself and flows eastward along the channel alignment. Runoff is combined with flows from sub-basins 4A, 4B, and 4C at D.P. 55.

Storm water runoff collected in the regional channel will be directed easterly to the two existing 42-inch culverts immediately north of Seneca Street. From that point, flows travel via open channels and additional 42-inch culverts to the Regional Detention Pond at Wake Robin Lane and Regency Drive.

Two swales along the south edge of the Overlook Fourth Filing site allow sidewalk access to the pedestrian walkway system within the regional drainage

STORM DRAINAGE SYSTEM PRELIMINARY DESIGN DATA

SUBDIVISION OVERLOOK No. 4 STORM 2 yr (developed) cf = 1.00
 CALCULATED BY DKT DATE 06/05/95

D.P. LOC.	BASINS	LENGTH (ft)	tc (min)	FLOW TIME (L)		tc (min)	C	INTENS (In/hr)	AREA (ac)	DIRECT RUNOFF (cfs)	OTHER RUNOFF (cfs)	TOTAL RUNOFF (cfs)	STREET		PIPE		STREET		PIPE		REMARKS	
				STREET (min)	PIPE (min)								SLOPE (%)	CAPACIT (cfs)	SLOPE (%)	SIZE (in)	CAPACIT (cfs)	DESIGN (cfs)	VELOCIT (ft/s)	DESIGN (cfs)		VELOCIT (ft/s)
1	2		19.8			19.8	0.85	1.87	2.78	4.9		4.9	0.60	8.4								
2	Upstream 0-2 & upstream basins		19.8			19.8	0.85	1.87	2.78	4.9	37.5	37.5										SWMM hydrology=4.4 cfs 4.4 cfs into 10' inlet #14 from SWMM model use 2 10' inlets for 100-year Lagged flow=38.7 cfs from SWMM model See regional channel section for pipe hydraulics
10	1		5.5			5.5	0.85	3.13	1.90	5.1		5.1	0.60	8.4								
21	2A		7.0			7.0	0.85	2.85	4.54	11.2		11.2	0.60	8.4								4.5 cfs into 15' inlet #10,
21	1,2A	225	5.6	2.6		8.2	0.85	2.69	6.54	15.0	-4.5	10.5	0.60	8.4								0.6 cfs carryover IL: 10->21 inlet moved 25' N of D.P.
21-23	2B	410	8.2	4.7		12.8	0.35	2.09	1.72	1.3		0.9	0.60	8.4								7.5 cfs into 15' inlet #21, 3.0 cfs carryover Total pipe flow=12.0 cfs IL: 21->23
23	1,2A,2B		15.5			15.5	0.75	2.09	8.28	12.9	-12.0	0.9	0.60	8.4								
32	3A		23.4			23.4	0.50	1.71	5.52	4.7		4.7	0.60	8.4								
23	1,2A,2B, 3A	220	23.4	2.5		25.9	0.85	1.83	13.78	14.5	-12.0	2.5	0.60	8.4								U/S street slope 1.00% IL: 32->23
38	3C		10.5			10.5	0.48	2.48	0.72	0.9		0.9	2.40	10.7								
35	3B		17.2			17.2	0.58	2.00	4.91	5.7		5.7	1.00	8.8								0.9 cfs into 5' inlet #38, 0 cfs carryover 5.7 cfs into 10' inlet #35, 0 cfs carryover use 15' inlet for 100-yr IL: 38->36 Total pipe flow=6.9 cfs Lagged pipe flow=6.4 cfs
18-35	3B,3C	38	10.5	0.2		10.7		2.48				6.4	0.60									
35			17.2			17.2	0.57	2.00	5.83	6.4		6.4	0.60	18	8:1	sump						IL: 35->23 Total pipe flow=18.6 cfs Lagged pipe flow=17.2 cfs
15-23	1,2A,2B, 3A,3B,3C	280	17.2	1.0		18.2		1.94				19.7	0.60	8.4								
23			25.9			25.9	0.82	1.63	19.41	19.7	-17.2	2.5	0.60	8.4								
43	4A		12.8			12.8	0.53	2.29	4.14	5.0		5.0	1.48	8.4								
48	4B		8.1			8.1	0.84	2.70	1.35	2.3		2.3	2.00	9.8								
48	4C		7.8			7.8	0.82	2.73	0.77	1.3		1.3	0.71	5.8								
48	4A,4B,4C	207	12.8	1.9		14.7	0.58	2.16	6.28	7.8		7.8	0.58	13.0								IL: 43->46 7.8 cfs into 10' inlet #46, 0 cfs carryover use 15' inlet for 100-yr
50			18.8			18.8	0.25	1.92	1.53	0.7		0.7										
51	5A		13.7			13.7	0.50	2.82	1.53	1.7		1.7	0.78	6.0								1.7 cfs into 5' inlet #51

L-10

STORM DRAINAGE SYSTEM PRELIMINARY DESIGN DATA

SUBDIVISION OVERLOOK No. 4 STORM 100 yr (developed) cf = 1.25
 CALCULATED BY DKT DATE 06/03/85

D.P. LOC.	BASIN#	LENGTH (ft)	tc (min)	FLOW TIME (L)		tc' (min)	C	INTENSI (in/hr)	AREA (ac)	DIRECT RUNOFF (cfs)	OTHER RUNOFF (cfs)	TOTAL RUNOFF (cfs)	STREET		PIPE		STREET		PIPE		REMARKS	
				STREET (min)	PIPE (min)								SLOPE (%)	CAPACIT (cfs)	SLOPE (%)	SIZE (in)	CAPACIT (cfs)	DESIGN (cfs)	VELOCIT (ft/s)	DESIGN (cfs)		VELOCIT (ft/s)
2	0-2		18.9			18.9	0.95	5.42	2.78	17.9		17.9	0.80	125.9								
2	upstream		18.9			18.9	0.95	5.42	2.78	17.9	182.8	182.6										17.9 cfs into 2 10' inlets #14 & #16 from SWMM model Lagged flow=189.4 cfs from SWMM model See regional channel section for pipe hydraulics
2	0-2 & upstream basins		18.9			18.9	0.95	5.42	2.78	17.9	171.5	189.4										
10	1		5.8			5.8	0.85	8.80	1.90	17.8		17.8	0.60	125.9								
21	2A		7.0			7.0	0.85	8.30	4.84	40.9		40.9					6.9	1.5	10.9	5.1	10.9 cfs into 15' inlet #10,	
21	1,2A	225	5.8	2.5		8.2	0.85	7.80	6.54	54.2	-10.9	43.3	0.60	125.9	0.60	21	12.3				8.6 cfs carryover tl: 10->21	
21-23																						18.0 cfs into 15' inlet #21, 30.9 cfs carryover Total pipe flow=28.9 cfs tl: 21->23
23	2B	410	8.2	4.7		12.8				4.7			0.80									
23	1,2A,2B		14.2			14.2	0.35	6.19	1.72	47.7	-28.9	18.8	0.60	125.9	0.60	30	31.8	18.8	1.5	28.9	6.5	
32	3A		21.1			21.1	0.50	5.07	5.52	17.5		17.5	0.60	43.2								
23	1,2A,2B, 3A	220	21.1	2.5		23.6	0.65	4.84	13.78	54.0	-28.9	25.1	0.60	125.9	0.60	30	31.8	25.1	1.5	28.9	6.5	U/S street slope 1.00% tl: 32->23
38	3C		8.7			8.7	0.48	7.70	0.72	3.3		3.3	2.40	86.3	0.60	15	5.0	sump		3.3	3.3	
35	3B		15.3			15.3	0.58	8.03	4.81	21.5		21.5	1.00	55.7				sump				
18-35		36	8.7		0.2	8.9		7.60														
35	3B,3C		15.3			15.3	0.57	8.03	5.83	24.1		24.1	0.60		0.61	27	24.2	sump		24.1	6.3	Total pipe flow=25.0 cfs Lagged pipe flow=24.1 cfs tl: 38->35
15-23		280	15.3		0.7	16.0		6.80					0.60									
23	1,2A,2B, 3A,3B,3C		23.6			23.6	0.62	4.84	19.41	73.3	-53.0	20.3	0.60	125.9	0.65	36	53.8	20.3	1.5	53.0	7.8	Total pipe flow=53.9 cfs Lagged pipe flow=53.0 cfs
43	4A		11.3			11.3	0.53	6.95	4.14	19.1		19.1	1.48	67.3								
46	4B		8.9			8.9	0.64	8.30	1.35	9.0		9.0	2.00	78.8								
46	4C		8.3			8.3	0.62	8.50	0.77	5.1		5.1	0.71	47.0								
46	4A,4B,4C	207	11.3	1.9		13.2	0.56	6.45	6.28	28.5		28.5	0.88	52.3	2.00	24	32.0	sump		28.5	10.2	tl: 43->46 28.5 cfs into 15' inlet #46, 0 cfs carryover
50			17.2			17.2	0.25	5.82	1.93	2.7		2.7										
51	5A		11.3			11.3	0.50	8.85	1.53	6.8		6.8	0.76	48.6								
53	5B		21.0			21.0	0.31	5.07	3.40	6.7		6.7										
1-53		505	11.3	2.8	drainway	14.1																
53	5A,5B		21.0			21.0	0.37	5.07	4.93	11.5		11.5	3.00									6.6 cfs into 5' inlet #51 tl: 51->53 @ 3.05 ft/s flow in channel



UDINLET: INLET HYDARULICS AND SIZING
DEVELOPED BY

DR. JAMES GUO, CIVIL ENG DEPT. U OF COLORADO AT DENVER
SUPPORTED BY METRO DENVER CITIES/COUNTIES AND UD&FCD

USER:KEVIN GINGERY-RDB INC FT. COLLINS COLORADO.....
ON DATE 05-26-1994 AT TIME 12:18:27

*** PROJECT TITLE: Overlook #4 2-year

*** CURB OPENING INLET HYDRAULICS AND SIZING:

*From Overlook at
Woodridge
Report*

INLET ID NUMBER: 10

INLET HYDRAULICS: ON A GRADE.

GIVEN INLET DESIGN INFORMATION:

GIVEN CURB OPENING LENGTH (ft)= 15.00
REQUIRED CURB OPENING LENGTH (ft)= 16.78
IDEAL CURB OPENNING EFFICIENCY = 0.98
ACTURAL CURB OPENNING EFFICIENCY = 0.95

STREET GEOMETRIES:

STREET LONGITUDINAL SLOPE (%) = 0.60
STREET CROSS SLOPE (%) = 2.00
STREET MANNING N = 0.016
GUTTER DEPRESSION (inch)= 2.00
GUTTER WIDTH (ft) = 2.00

STREET FLOW HYDRAULICS:

WATER SPREAD ON STREET (ft) = 13.56
GUTTER FLOW DEPTH (ft) = 0.44
FLOW VELOCITY ON STREET (fps)= 2.53
FLOW CROSS SECTION AREA (sq ft)= 2.01
GRATE CLOGGING FACTOR (%)= 50.00
CURB OPENNING CLOGGING FACTOR(%)= 10.00

INLET INTERCEPTION CAPACITY:

IDEAL INTERCEPTION CAPACITY (cfs)= 5.01
BY FAA HEC-12 METHOD: DESIGN FLOW (cfs)= 5.10 ← Q_z
FLOW INTERCEPTED (cfs)= 4.83
CARRY-OVER FLOW (cfs)= 0.27
BY DENVER UDFCD METHOD: DESIGN FLOW (cfs)= 5.10
FLOW INTERCEPTED (cfs)= 4.51
CARRY-OVER FLOW (cfs)= 0.59

UDINLET: INLET HYDARULICS AND SIZING
DEVELOPED BY

DR. JAMES GUO, CIVIL ENG DEPT. U OF COLORADO AT DENVER
SUPPORTED BY METRO DENVER CITIES/COUNTIES AND UD&FCD

USER:KEVIN GINGERY-RDB INC FT. COLLINS COLORADO.....
ON DATE 05-26-1994 AT TIME 12:18:59

*** PROJECT TITLE: Overlook #4 100-year

*** CURB OPENING INLET HYDRAULICS AND SIZING:

INLET ID NUMBER: 10

INLET HYDRAULICS: ON A GRADE.

GIVEN INLET DESIGN INFORMATION:

GIVEN CURB OPENING LENGTH	(ft)=	15.00
REQUIRED CURB OPENING LENGTH	(ft)=	36.06
IDEAL CURB OPENING EFFICIENCY	=	0.62
ACTUAL CURB OPENING EFFICIENCY	=	0.57

STREET GEOMETRIES:

STREET LONGITUDINAL SLOPE	(%) =	0.60
STREET CROSS SLOPE	(%) =	2.00
STREET MANNING N	=	0.016
GUTTER DEPRESSION	(inch)=	2.00
GUTTER WIDTH	(ft) =	2.00

STREET FLOW HYDRAULICS:

WATER SPREAD ON STREET	(ft) =	23.50
GUTTER FLOW DEPTH	(ft) =	0.64
FLOW VELOCITY ON STREET	(fps)=	3.40
FLOW CROSS SECTION AREA	(sq ft)=	5.69
GRATE CLOGGING FACTOR	(%)=	50.00
CURB OPENING CLOGGING FACTOR	(%)=	10.00

INLET INTERCEPTION CAPACITY:

IDEAL INTERCEPTION CAPACITY	(cfs)=	12.09	
BY FAA HEC-12 METHOD:	DESIGN FLOW	(cfs)=	19.50
	FLOW INTERCEPTED	(cfs)=	11.12
	CARRY-OVER FLOW	(cfs)=	8.38
BY DENVER UDFCD METHOD:	DESIGN FLOW	(cfs)=	19.50
	FLOW INTERCEPTED	(cfs)=	10.88
	CARRY-OVER FLOW	(cfs)=	8.62

UDINLET: INLET HYDARULICS AND SIZING
DEVELOPED BY
DR. JAMES GUO, CIVIL ENG DEPT. U OF COLORADO AT DENVER
SUPPORTED BY METRO DENVER CITIES/COUNTIES AND UD&FCD

USER:KEVIN GINGERY-RDB INC FT. COLLINS COLORADO.....
ON DATE 05-26-1994 AT TIME 13:18:44

*** PROJECT TITLE: Overlook #4 2-year

*** CURB OPENING INLET HYDRAULICS AND SIZING:

INLET ID NUMBER: 21

INLET HYDRAULICS: ON A GRADE.

*From Overlook
at Woodridge
Report*

GIVEN INLET DESIGN INFORMATION:

GIVEN CURB OPENING LENGTH	(ft)=	15.00
REQUIRED CURB OPENING LENGTH	(ft)=	25.52
IDEAL CURB OPENING EFFICIENCY	=	0.80
ACTUAL CURB OPENING EFFICIENCY	=	0.74

STREET GEOMETRIES:

STREET LONGITUDINAL SLOPE (%)	=	0.60
STREET CROSS SLOPE (%)	=	2.00
STREET MANNING N	=	0.016
GUTTER DEPRESSION	(inch)=	2.00
GUTTER WIDTH	(ft) =	2.00

STREET FLOW HYDRAULICS:

WATER SPREAD ON STREET	(ft) =	18.44
GUTTER FLOW DEPTH	(ft) =	0.54
FLOW VELOCITY ON STREET	(fps)=	2.96
FLOW CROSS SECTION AREA	(sq ft)=	3.57
GRATE CLOGGING FACTOR	(%)=	50.00
CURB OPENING CLOGGING FACTOR	(%)=	10.00

INLET INTERCEPTION CAPACITY:

IDEAL INTERCEPTION CAPACITY	(cfs)=	8.37
BY FAA HEC-12 METHOD: DESIGN FLOW	(cfs)=	10.50
FLOW INTERCEPTED	(cfs)=	7.79
CARRY-OVER FLOW	(cfs)=	2.71
BY DENVER UDFCD METHOD: DESIGN FLOW	(cfs)=	10.50
FLOW INTERCEPTED	(cfs)=	7.53
CARRY-OVER FLOW	(cfs)=	2.97

UDINLET: INLET HYDARULICS AND SIZING
DEVELOPED BY
DR. JAMES GUO, CIVIL ENG DEPT. U OF COLORADO AT DENVER
SUPPORTED BY METRO DENVER CITIES/COUNTIES AND UD&FCD

USER:KEVIN GINGERY-RDB INC FT. COLLINS COLORADO.....
ON DATE 05-26-1994 AT TIME 13:19:09

*** PROJECT TITLE: Overlook #4 100-year

*** CURB OPENING INLET HYDRAULICS AND SIZING:

INLET ID NUMBER: 21

100-42

INLET HYDRAULICS: ON A GRADE.

GIVEN INLET DESIGN INFORMATION:

GIVEN CURB OPENING LENGTH	(ft)=	15.00
REQUIRED CURB OPENING LENGTH	(ft)=	59.26
IDEAL CURB OPENING EFFICIENCY	=	0.41
ACTUAL CURB OPENING EFFICIENCY	=	0.37

STREET GEOMETRIES:

STREET LONGITUDINAL SLOPE (%)	=	0.60
STREET CROSS SLOPE (%)	=	2.00
STREET MANNING N	=	0.016
GUTTER DEPRESSION (inch)	=	2.00
GUTTER WIDTH (ft)	=	2.00

STREET FLOW HYDRAULICS:

WATER SPREAD ON STREET (ft)	=	33.63
GUTTER FLOW DEPTH (ft)	=	0.84
FLOW VELOCITY ON STREET (fps)	=	4.24
FLOW CROSS SECTION AREA (sq ft)	=	11.47
GRATE CLOGGING FACTOR (%)	=	50.00
CURB OPENING CLOGGING FACTOR (%)	=	10.00

INLET INTERCEPTION CAPACITY:

IDEAL INTERCEPTION CAPACITY (cfs)	=	19.98
BY FAA HEC-12 METHOD: DESIGN FLOW (cfs)	=	48.90
FLOW INTERCEPTED (cfs)	=	18.20
CARRY-OVER FLOW (cfs)	=	30.70
BY DENVER UDFCD METHOD: DESIGN FLOW (cfs)	=	48.90
FLOW INTERCEPTED (cfs)	=	17.99
CARRY-OVER FLOW (cfs)	=	30.91

Harmony Road W. FE

16j

UDINLET: STREET FLOW ANALYSIS

DEVELOPED BY

DR JAMES GUO, CIVIL ENG DEPT, U OF COLORADO AT DENVER
SUPPORTED BY METRO DENVER CITIES/COUNTIES AND UDSFCD

USER: KEVIN GINGERY-RDB INC FT. COLLINS COLORADO.....
ON DATE 05-26-1994 AT TIME 13:37:39

Carryover flow at inlet #10

** STREET GUTTER HYDRAULICS

GIVEN GUTTER GEOMETRIES:

LONGITUDINAL SLOPE	(%) =	0.60
CROSS SLOPE	(%) =	2.00
DEPRESSION AT GUTTER	(inch) =	2.00
GUTTER WIDTH	(feet) =	2.00
STREET MANNING ROUGHNESS N	=	0.016

STREET UNDER THE GIVEN FLOW:

PEAK RUNOFF FLOW RATE	(cfs) =	0.60
FLOW CARRIED BY GUTTER	(cfs) =	0.58
FLOW CARRIED BY STREET	(cfs) =	0.02
WATER SPREAD ON STREET	(ft) =	3.71
GUTTER FLOW DEPTH	(in) =	2.89
AVERAGE FLOW VELOCITY	(fps) =	1.97

UDINLET: STREET FLOW ANALYSIS

DEVELOPED BY

DR JAMES GUO, CIVIL ENG DEPT, U OF COLORADO AT DENVER
SUPPORTED BY METRO DENVER CITIES/COUNTIES AND UDSFCD

USER: KEVIN GINGERY-RDB INC FT. COLLINS COLORADO.....
ON DATE 05-26-1994 AT TIME 13:37:52

Flow approaching inlet #21

*** STREET GUTTER HYDRAULICS

GIVEN GUTTER GEOMETRIES:

LONGITUDINAL SLOPE	(%) =	0.60
CROSS SLOPE	(%) =	2.00
DEPRESSION AT GUTTER	(inch) =	2.00
GUTTER WIDTH	(feet) =	2.00
STREET MANNING ROUGHNESS N	=	0.016

STREET UNDER THE GIVEN FLOW:

PEAK RUNOFF FLOW RATE	(cfs) =	10.50
FLOW CARRIED BY GUTTER	(cfs) =	3.59
FLOW CARRIED BY STREET	(cfs) =	6.92
WATER SPREAD ON STREET	(ft) =	18.41
GUTTER FLOW DEPTH	(in) =	6.42
AVERAGE FLOW VELOCITY	(fps) =	2.96

Overlook at Woodridge

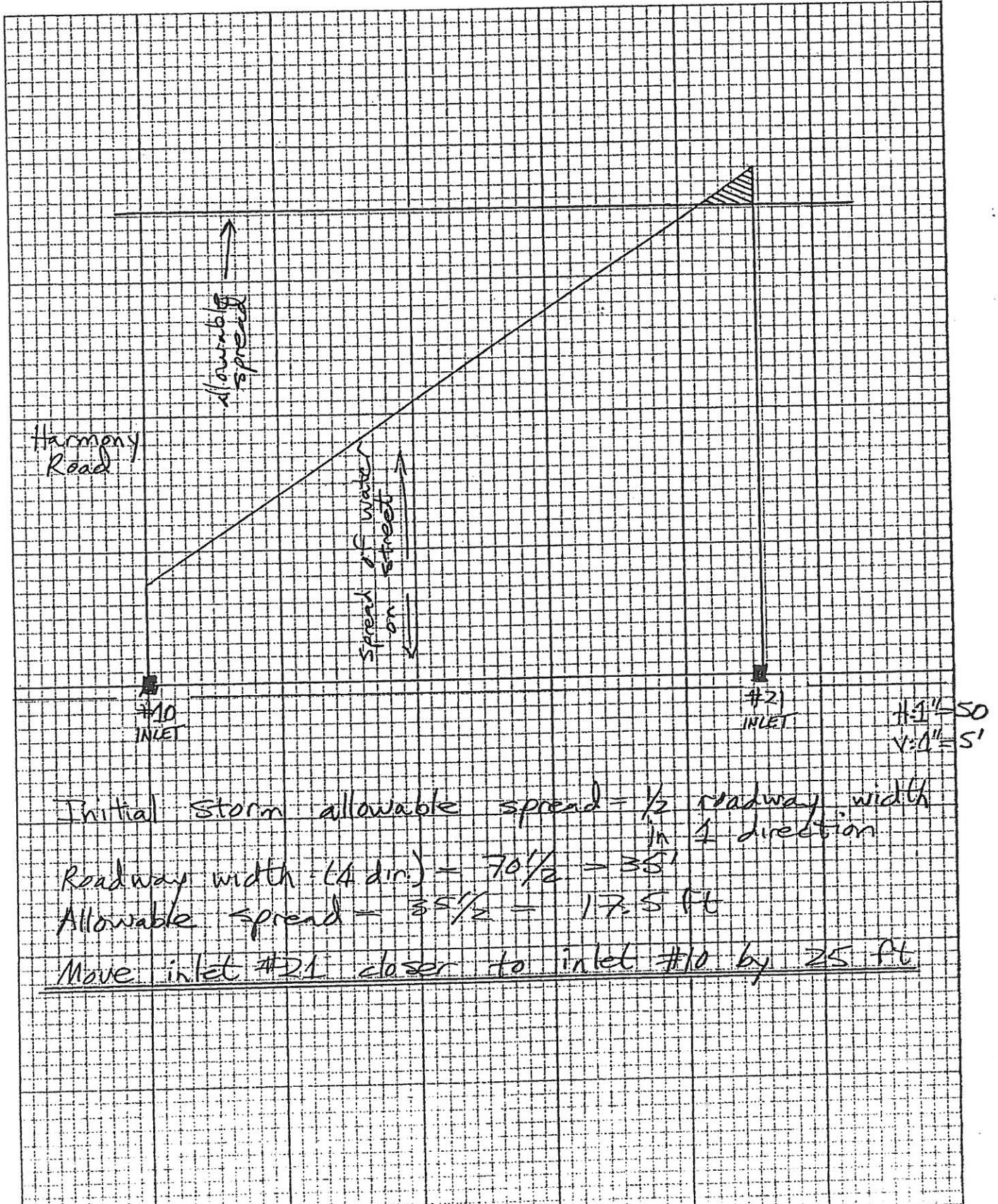

APPENDIX G

SOIL REPORT
AND
FEMA INFORMATION

Hydrologic Soil Group—Larimer County Area, Colorado
(Harmony Cottages)

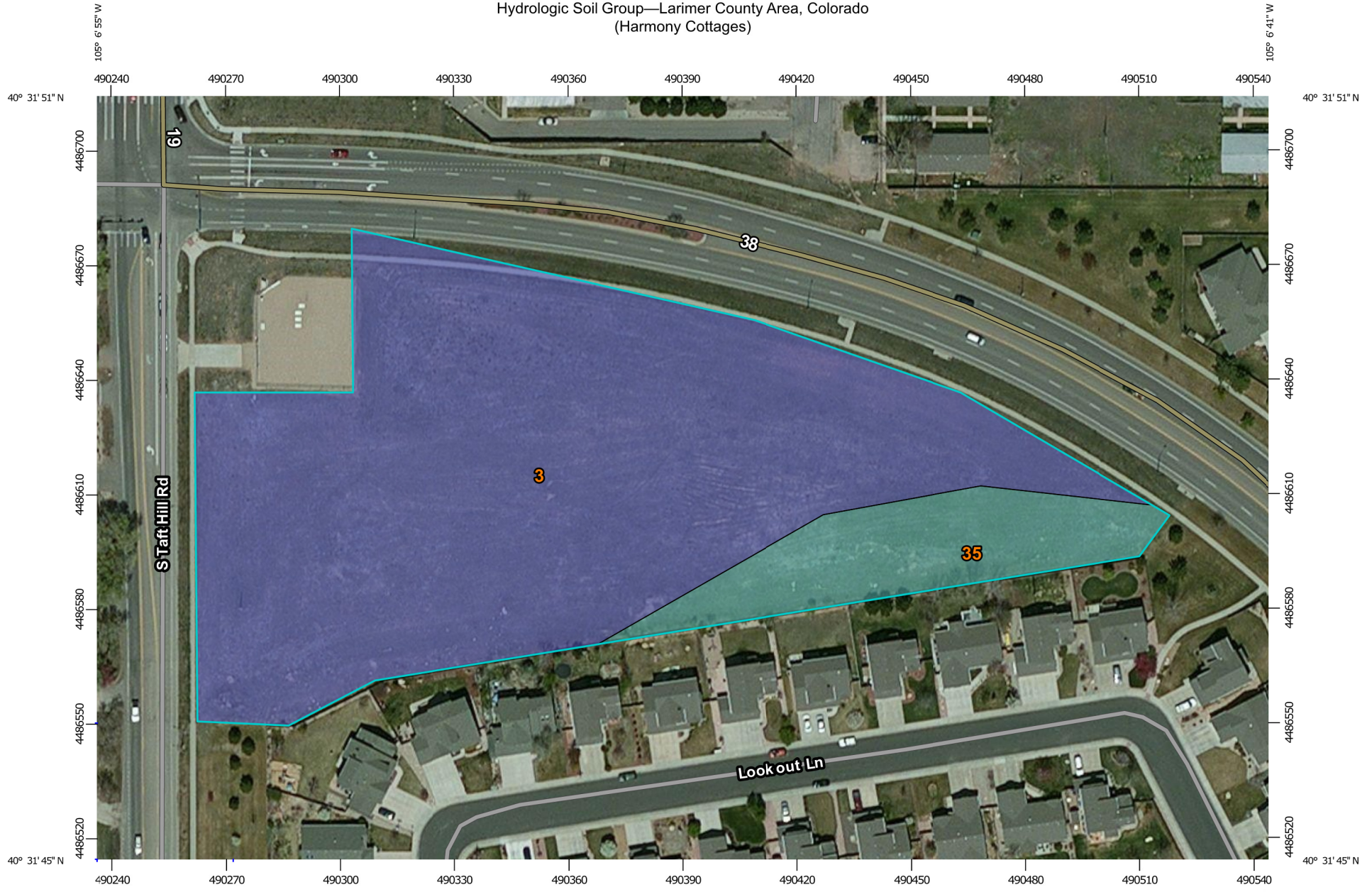

Map Scale: 1:1,410 if printed on A landscape (11" x 8.5") sheet.

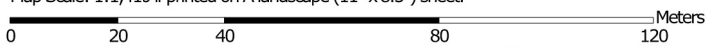

Map projection: Web Mercator Corner coordinates: WGS84 Edge tics: UTM Zone 13N WGS84

MAP LEGEND

Area of Interest (AOI)









 Area of Interest (AOI)

Soils

Soil Rating Polygons





 A
 A/D
 B
 B/D
 C
 C/D
 D
 Not rated or not available

Soil Rating Lines

 A
 A/D
 B
 B/D
 C
 C/D
 D
 Not rated or not available

Soil Rating Points





 A
 A/D
 B
 B/D

 C
 C/D
 D
 Not rated or not available

Water Features

 Streams and Canals

Transportation

 Rails
 Interstate Highways
 US Routes
 Major Roads
 Local Roads

Background

 Aerial Photography

MAP INFORMATION

The soil surveys that comprise your AOI were mapped at 1:24,000.

Warning: Soil Map may not be valid at this scale.

Enlargement of maps beyond the scale of mapping can cause misunderstanding of the detail of mapping and accuracy of soil line placement. The maps do not show the small areas of contrasting soils that could have been shown at a more detailed scale.

Please rely on the bar scale on each map sheet for map measurements.

Source of Map: Natural Resources Conservation Service
 Web Soil Survey URL: <http://websoilsurvey.nrcs.usda.gov>
 Coordinate System: Web Mercator (EPSG:3857)

Maps from the Web Soil Survey are based on the Web Mercator projection, which preserves direction and shape but distorts distance and area. A projection that preserves area, such as the Albers equal-area conic projection, should be used if more accurate calculations of distance or area are required.

This product is generated from the USDA-NRCS certified data as of the version date(s) listed below.

Soil Survey Area: Larimer County Area, Colorado
 Survey Area Data: Version 10, Sep 22, 2015

Soil map units are labeled (as space allows) for map scales 1:50,000 or larger.

Date(s) aerial images were photographed: Apr 22, 2011—Apr 28, 2011

The orthophoto or other base map on which the soil lines were compiled and digitized probably differs from the background imagery displayed on these maps. As a result, some minor shifting of map unit boundaries may be evident.

Hydrologic Soil Group

Hydrologic Soil Group— Summary by Map Unit — Larimer County Area, Colorado (CO644)				
Map unit symbol	Map unit name	Rating	Acres in AOI	Percent of AOI
3	Altvan-Satanta loams, 0 to 3 percent slopes	B	4.1	86.3%
35	Fort Collins loam, 0 to 3 percent slopes	C	0.6	13.7%
Totals for Area of Interest			4.7	100.0%

Description

Hydrologic soil groups are based on estimates of runoff potential. Soils are assigned to one of four groups according to the rate of water infiltration when the soils are not protected by vegetation, are thoroughly wet, and receive precipitation from long-duration storms.

The soils in the United States are assigned to four groups (A, B, C, and D) and three dual classes (A/D, B/D, and C/D). The groups are defined as follows:

Group A. Soils having a high infiltration rate (low runoff potential) when thoroughly wet. These consist mainly of deep, well drained to excessively drained sands or gravelly sands. These soils have a high rate of water transmission.

Group B. Soils having a moderate infiltration rate when thoroughly wet. These consist chiefly of moderately deep or deep, moderately well drained or well drained soils that have moderately fine texture to moderately coarse texture. These soils have a moderate rate of water transmission.

Group C. Soils having a slow infiltration rate when thoroughly wet. These consist chiefly of soils having a layer that impedes the downward movement of water or soils of moderately fine texture or fine texture. These soils have a slow rate of water transmission.

Group D. Soils having a very slow infiltration rate (high runoff potential) when thoroughly wet. These consist chiefly of clays that have a high shrink-swell potential, soils that have a high water table, soils that have a claypan or clay layer at or near the surface, and soils that are shallow over nearly impervious material. These soils have a very slow rate of water transmission.

If a soil is assigned to a dual hydrologic group (A/D, B/D, or C/D), the first letter is for drained areas and the second is for undrained areas. Only the soils that in their natural condition are in group D are assigned to dual classes.

Rating Options

Aggregation Method: Dominant Condition

Component Percent Cutoff: None Specified

Tie-break Rule: Higher

FEMA's National Flood Hazard Layer (Official)

Data from Flood Insurance Rate Maps (FIRMs) where available digitally. Try <http://bit.ly/1bPpUjq> (Unofficial) if this map is down



scott.mcafee@fema.dhs.gov | National Geospatial-Intelligence Agency (NGA); Delta State University; Esri

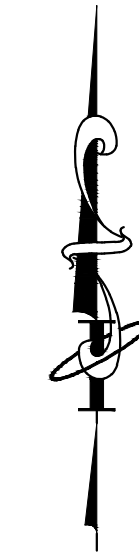
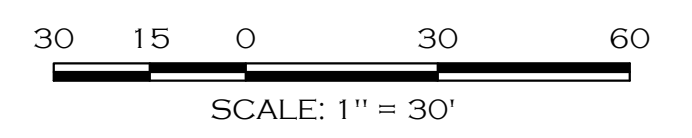
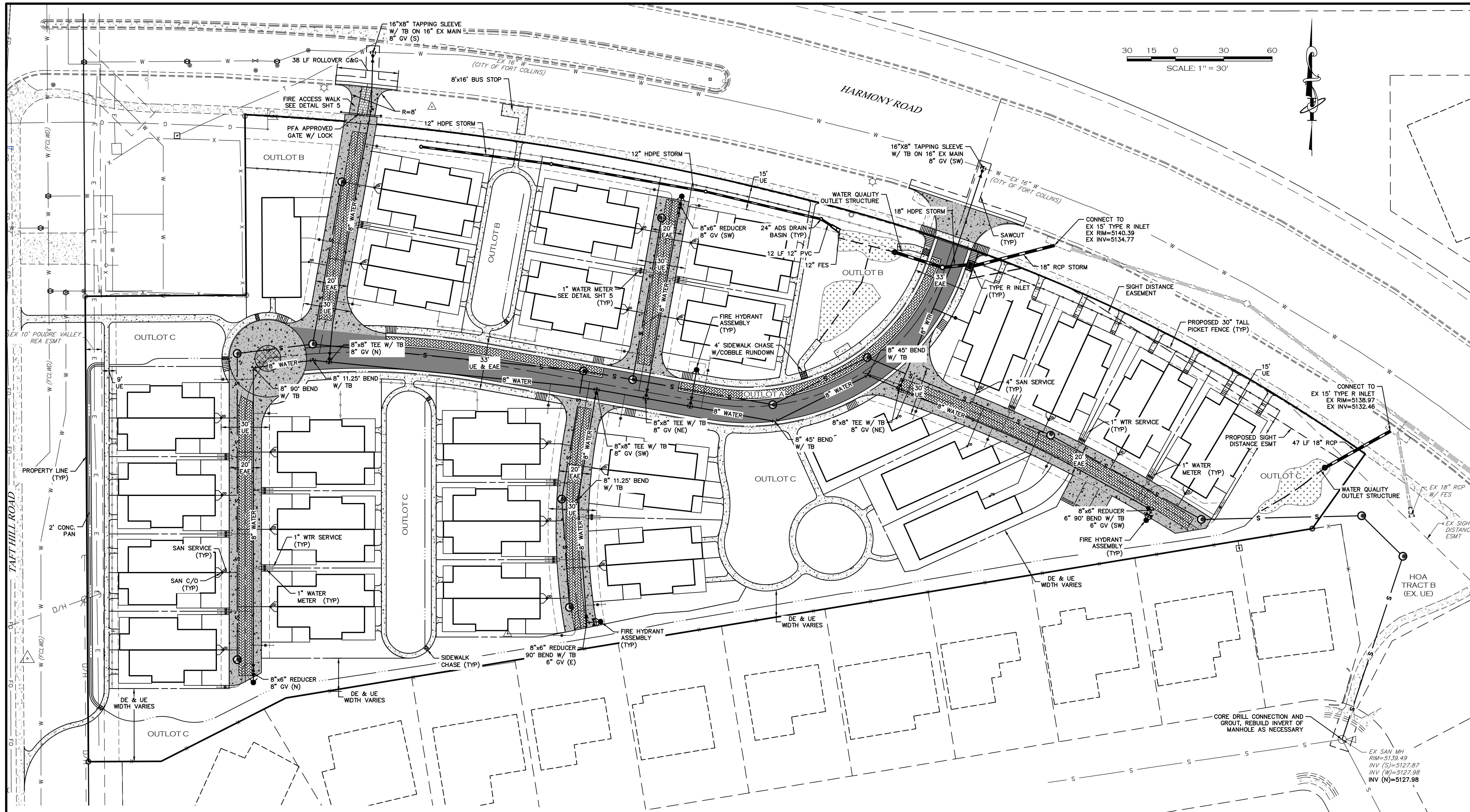

1218 W. Ash, Suite A
 Fort Collins, CO 80526
 Phone: (970) 974-3303
INTEREST CONSULTING GROUP

PREPARED FOR
HABITAT FOR HUMANITY
 4001 S. TAFT HILL ROAD
 FORT COLLINS, CO 80525
 PHONE: 970.223.4522

PROJECT NAME
HARMONY COTTAGES
 UTILITY PLAN

DATE: 01/20/16
 SCALE (H): 1"=30'
 SCALE (V): N/A
 DESIGNED BY: SJD
 CHECKED BY: RA

PROJ. NO. 1255-028-00

- NOTES:**
1. ALL STORM SEWER, SANITARY SEWER, AND WATER CONSTRUCTION, AS WELL AS POWER AND OTHER "DRY" UTILITY INSTALLATIONS, SHALL CONFORM TO THE CITY OF FORT COLLINS STANDARDS AND SPECIFICATIONS CURRENT AT THE DATE OF APPROVAL OF THE PLANS BY THE LOCAL ENGINEER.
 2. STORM SEWER PIPE SHALL BE RCP OR PVC WITH WATER TIGHT JOINTS AS SPECIFIED ON THE PLAN. ALL STORM SEWER SHALL BE INSPECTED BY THE CITY OF FORT COLLINS.
 3. LENGTH OF PIPE IS MEASURED FROM CENTER OF STRUCTURE TO CENTER OF STRUCTURE AND INCLUDES THE FLARED END SECTION.
 4. WATER MAINS SHALL BE PVC (IC-900) AS SPECIFIED BY THE CITY OF FORT COLLINS STANDARD PLANS AND SPECIFICATIONS.
 5. ALL WATER SERVICES SHALL BE INSTALLED AT A MINIMUM OF 5 FEET BELOW FINISHED FLOOR ELEVATION AND SHALL BE TYPE K COPPER AS SPECIFIED BY THE CITY OF FORT COLLINS STANDARD PLANS AND SPECIFICATIONS.

6. ALL SANITARY SEWER PIPE SHALL BE PVC (SDR 35) UNLESS OTHERWISE NOTED ON THE PLAN. SEWER PIPE SHALL BE AS SPECIFIED BY THE CITY OF FORT COLLINS STANDARD PLANS AND SPECIFICATIONS.
8. LIMITS OF STREET CUT SHOWN ARE APPROXIMATE. FINAL LIMITS ARE TO BE DETERMINED IN THE FIELD BY CITY ENGINEER INSPECTOR. ALL REPAIRS TO BE IN ACCORDANCE WITH CITY STREET REPAIR STANDARDS.
9. CITY OF FORT COLLINS LIGHT & POWER (L&P) SHALL INSTALL PRIMARY LINE FROM CONNECTION POINT TO ELECTRIC VAULT, SECONDARY LINES FROM VAULT TO METER, AND BUILDING METER. CONTRACTOR SHALL COORDINATE WITH FORT COLLINS METER GROUP FOR METER LOCATION. CONTACT CITY OF FORT COLLINS LIGHT & POWER FOR THEIR CURRENT REQUIREMENTS.
10. ANY DAMAGED CURB, GUTTER AND SIDEWALK EXISTING PRIOR TO CONSTRUCTION, AS WELL AS STREETS, SIDEWALKS, CURBS AND GUTTERS, DESTROYED, DAMAGED OR REMOVED DUE TO CONSTRUCTION OF THIS PROJECT, SHALL BE REPLACED OR RESTORED TO CITY OF FORT COLLINS STANDARDS AT THE DEVELOPER'S EXPENSE PRIOR TO THE ACCEPTANCE OF COMPLETED IMPROVEMENTS AND/OR PRIOR TO THE ISSUANCE OF THE FIRST CERTIFICATE OF OCCUPANCY.
11. ALL PRIVATE DRIVE AND PRIVATE ALLEYS SHALL BE PRIVATELY MAINTAINED.

**PRELIMINARY
 NOT FOR CONSTRUCTION**

LEGEND

- RAIN GARDEN W/ BIORETENTION MEDIA
- PROPOSED PERMEABLE PAVER
- PROPOSED ASPHALT
- PROPOSED CONCRETE PAVEMENT
- PROPOSED STAMPED CONCRETE PAVEMENT
- PROPOSED CONCRETE

CALL UTILITY NOTIFICATION
 CENTER OF COLORADO
811
 CALL 2-BUSINESS DAYS IN ADVANCE
 BEFORE YOU DIG, GRADE, OR EXCAVATE
 FOR THE MARKING OF UNDERGROUND
 MEMBER UTILITIES.

CITY OF FORT COLLINS, COLORADO
 UTILITY PLAN APPROVAL

APPROVED:	CITY ENGINEER	DATE
CHECKED BY:	WATER & WASTEWATER UTILITY	DATE
CHECKED BY:	STORMWATER UTILITY	DATE
CHECKED BY:	PARKS & RECREATION	DATE
CHECKED BY:	TRAFFIC ENGINEER	DATE
CHECKED BY:	NATURAL RESOURCES	DATE

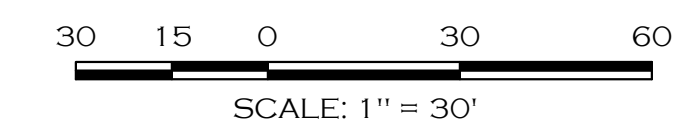

1218 W. Ash, Suite A
 Fort Collins, Colorado 80525
 Phone: (970) 874-3303
 Fax: (970) 874-3303
INTEREST CONSULTING GROUP

PREPARED FOR
HABITAT FOR HUMANITY
 4001 S. TAFT HILL ROAD
 FORT COLLINS, CO 80525
 PHONE: 970.223.4522

PROJECT NAME
HARMONY COTTAGES
GRADING PLAN

DATE: 01/20/16
 SCALE (H): 1"=30'
 SCALE (V): N/A
 DESIGNED BY: SJD
 CHECKED BY: RA

PROJ. NO. 1255-028-00

3 OF 5

- NOTES:**
1. TFE = TOP OF FOUNDATION ELEVATION, GE=GARAGE ELEVATION
 2. CONTRACTOR RESPONSIBLE FOR ALL SURFACE REPAIR/REPLACEMENT TO RESTORE SIDEWALKS, PAVEMENT, CURB/GUTTER AND SOD AREAS DISTURBED BY NEW WORK. REPAIR/REPLACEMENTS SHALL BE COMPLETED PER CITY OF FORT COLLINS STANDARDS AT CONTRACTOR EXPENSE.
 3. SIDEWALKS ADJACENT TO STREETS, DRIVES, PARKING LOTS AND ACCESS SLOPE 2% TOWARDS THE CURB LINE.
 4. ALL SUBGRADE TO BE PLACED/COMPACTED PER GEOTECHNICAL ENGINEER RECOMMENDATIONS. ALL PAVEMENT SECTIONS PER GEOTECHNICAL ENGINEER RECOMMENDATIONS.
 5. SEE LANDSCAPE PLANS FOR REVEGETATION METHODS.

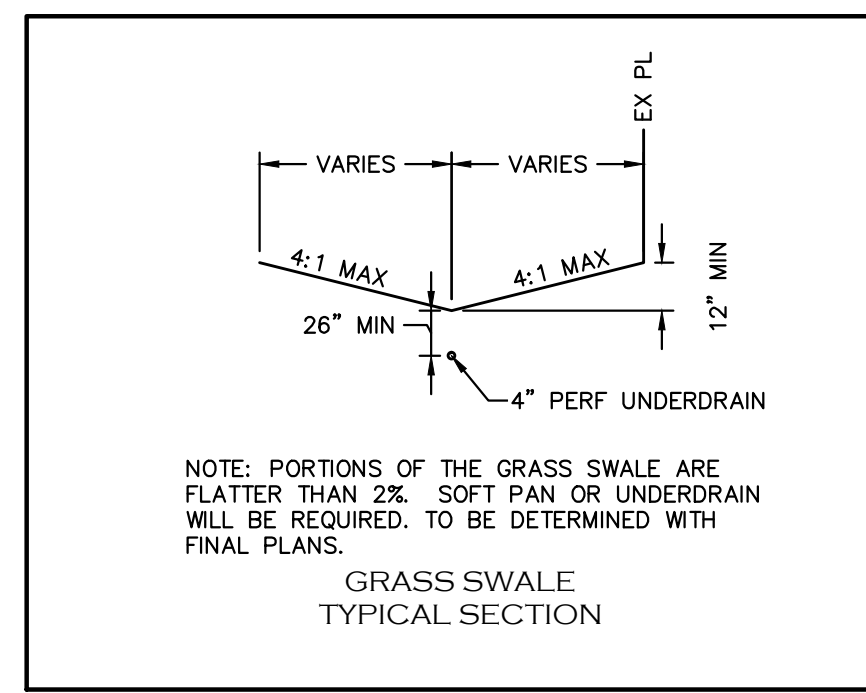

LEGEND

- RAIN GARDEN W/ BIORETENTION MEDIA
- PROPOSED POROUS PAVER

CALL UTILITY NOTIFICATION CENTER OF COLORADO
811
 CALL 2-BUSINESS DAYS IN ADVANCE BEFORE YOU DIG, GRADE, OR EXCAVATE FOR THE MARKING OF UNDERGROUND MEMBER UTILITIES.

CITY OF FORT COLLINS, COLORADO
 UTILITY PLAN APPROVAL

APPROVED:	_____	DATE	_____
CHECKED BY:	_____	DATE	_____
CHECKED BY:	_____	DATE	_____
CHECKED BY:	_____	DATE	_____
CHECKED BY:	_____	DATE	_____
CHECKED BY:	_____	DATE	_____

PRELIMINARY
NOT FOR CONSTRUCTION

S:\INTEREST\PROJECTS\1255-028-00_HARMONY_COTTAGES\DRAWINGS\GRADING_PLAN\1255-028-00_RP_P1.dwg, 1/20/16, 4:52 PM

1218 W. Ash, Suite A
 Colorado, 80502
 Website: www.iinterwest.com
 Fax: (970) 874-3303

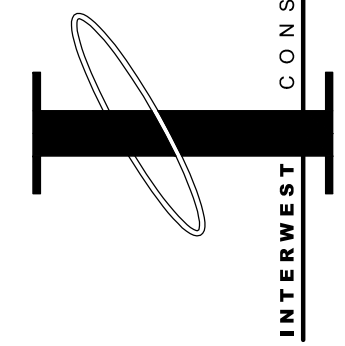

PREPARED FOR
HABITAT FOR HUMANITY
 4001 S. TAFT HILL ROAD
 FORT COLLINS, CO 80525
 PHONE: 970.223.4522

PROJECT NAME
HARMONY COTTAGES
 DRAINAGE PLAN

DATE: 01/20/16
 SCALE (H): 1"=40'
 SCALE (V): N/A
 DESIGNED BY: SJD
 CHECKED BY: RA

PROJ. NO. 1255-028-00

- NOTES:**
- SEE LANDSCAPE PLAN FOR PLANTINGS THROUGHOUT THE SITE.
 - THE TOP OF FOUNDATION ELEVATION SHOWN IS HIGHER THAN THE MINIMUM ELEVATION REQUIRED FOR PROTECTION FROM THE 100-YR STORM.
 - EROSION CONTROL MEASURES TO BE SHOWN DURING FINAL COMPLIANCE.

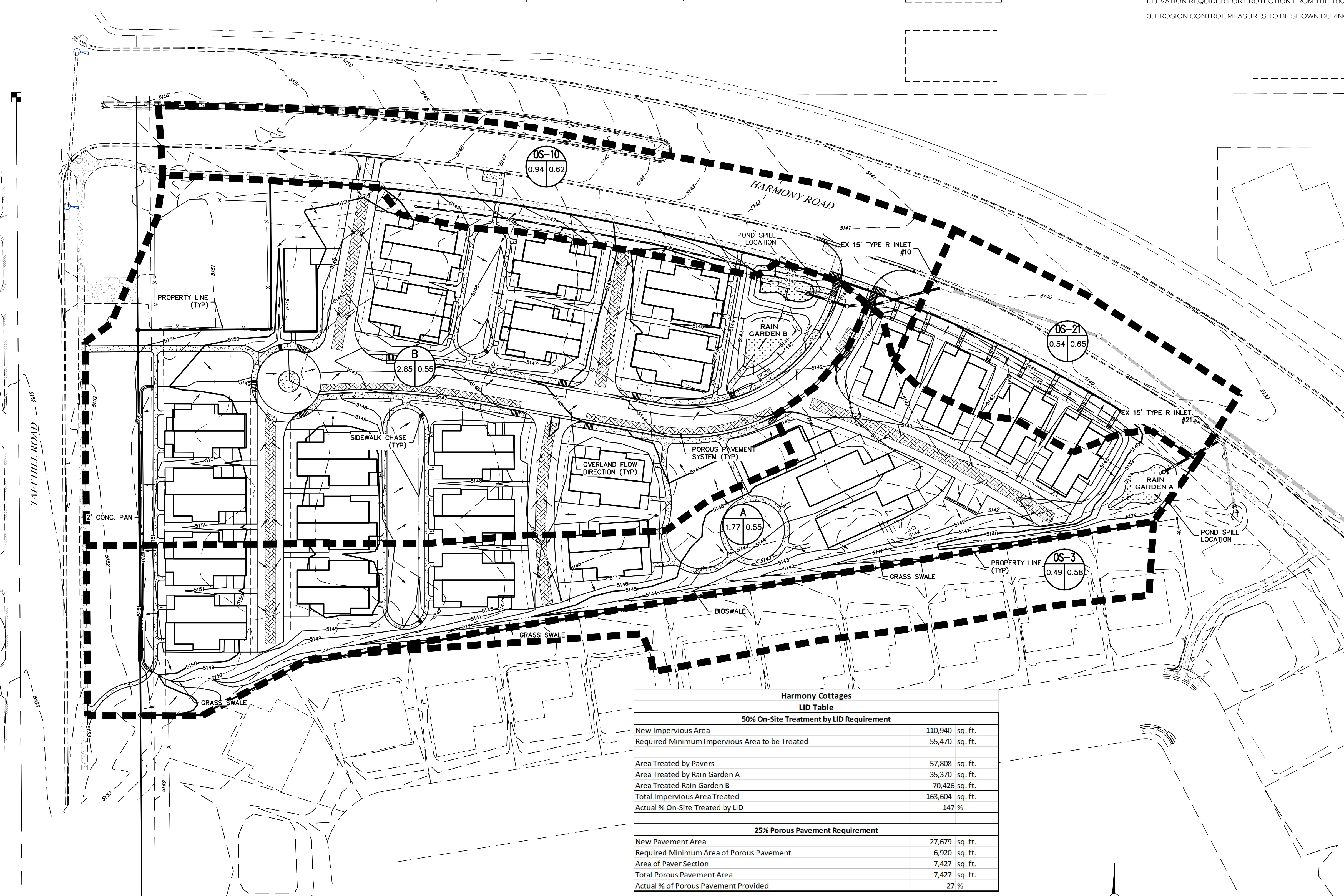

Harmony Cottages LID Table

50% On-Site Treatment by LID Requirement

New Impervious Area	110,940 sq. ft.
Required Minimum Impervious Area to be Treated	55,470 sq. ft.
Area Treated by Pavers	57,808 sq. ft.
Area Treated by Rain Garden A	35,370 sq. ft.
Area Treated Rain Garden B	70,426 sq. ft.
Total Impervious Area Treated	163,604 sq. ft.
Actual % On-Site Treated by LID	147 %

25% Porous Pavement Requirement

New Pavement Area	27,679 sq. ft.
Required Minimum Area of Porous Pavement	6,920 sq. ft.
Area of Paver Section	7,427 sq. ft.
Total Porous Pavement Area	7,427 sq. ft.
Actual % of Porous Pavement Provided	27 %

DRAINAGE SUMMARY TABLE

Design Point	Tributary Sub-basin	Area (ac)	C (10)	C (100)	tc (10) (min)	tc (100) (min)	Q(2)tot (cfs)	Q(10)tot (cfs)	Q(100)tot (cfs)	REMARKS
a	A	1.77	0.55	0.69	7.7	6.8	2.4	4.1	10.9	WQ Pond
b	B	2.85	0.55	0.69	14.0	12.5	3.0	5.2	13.8	Rain Garden
10	OS-10	0.94	0.62	0.78	8.6	7.8	1.4	2.4	6.3	Ex Inlet #10
21	OS-21	0.54	0.65	0.81	5.0	5.0	1.0	1.7	4.3	Ex Inlet #21
3	OS-3	0.49	0.58	0.73	8.6	7.6	0.7	1.2	3.6	Bioswale

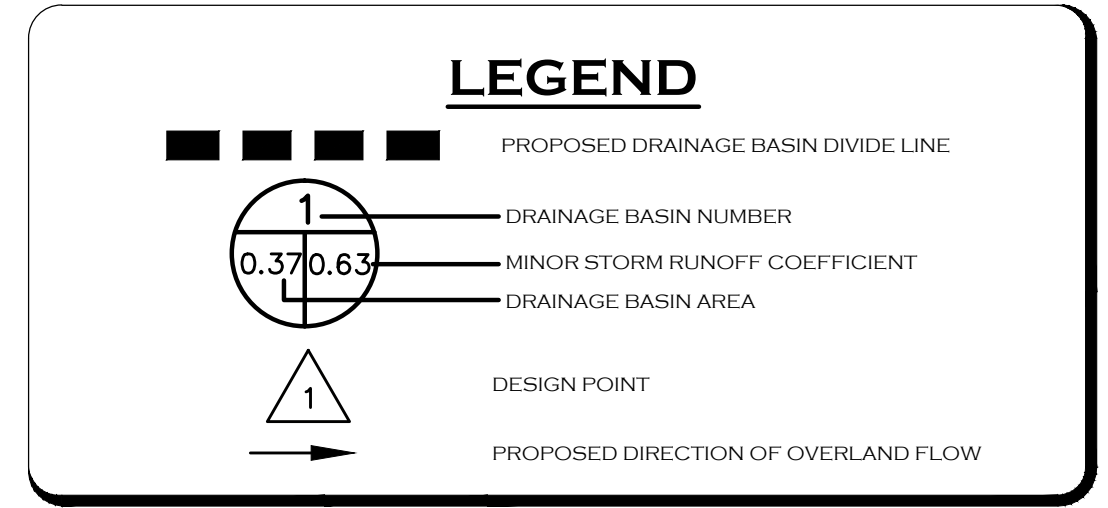

**PRELIMINARY
 NOT FOR CONSTRUCTION**

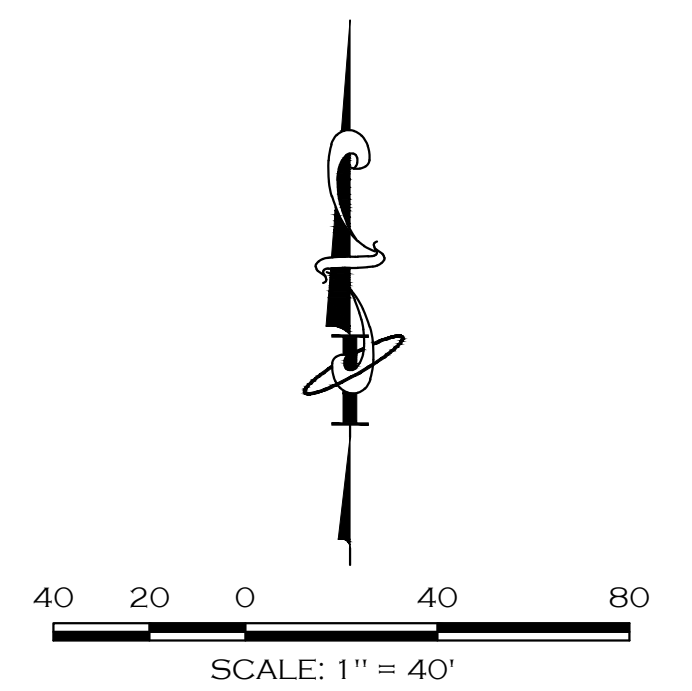

CALL UTILITY NOTIFICATION CENTER OF COLORADO
811
 CALL 2-BUSINESS DAYS IN ADVANCE BEFORE YOU DIG, GRADE, OR EXCAVATE FOR THE MARKING OF UNDERGROUND MEMBER UTILITIES.

K:\INTEREST PROJECTS\1255-028-00\HARMONY COTTAGES\DRAWINGS\DRAINAGE PLAN\1255-028-00 DR.PLAN_17172016.dwg

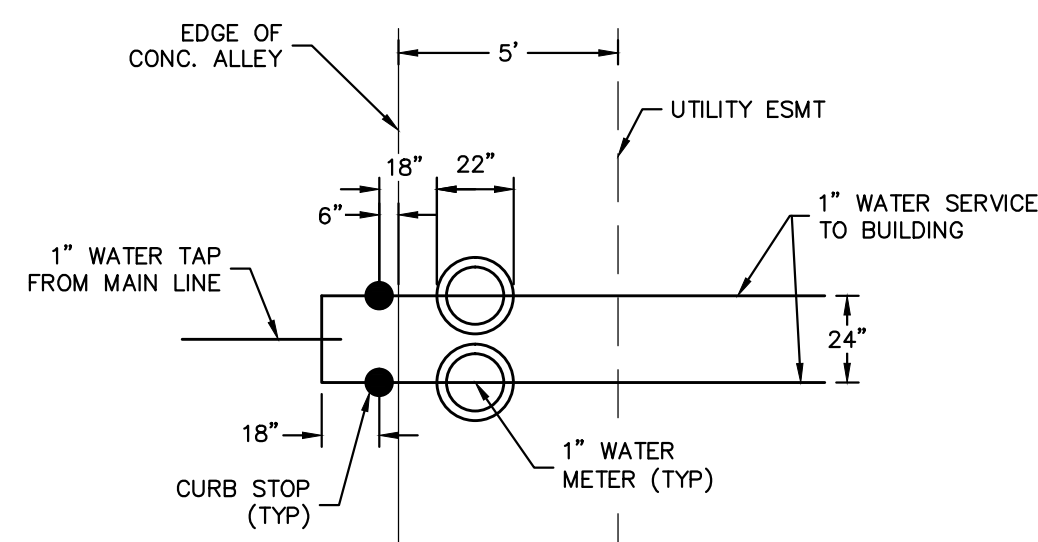

WATER METER TYPICAL LAYOUT
N.T.S.

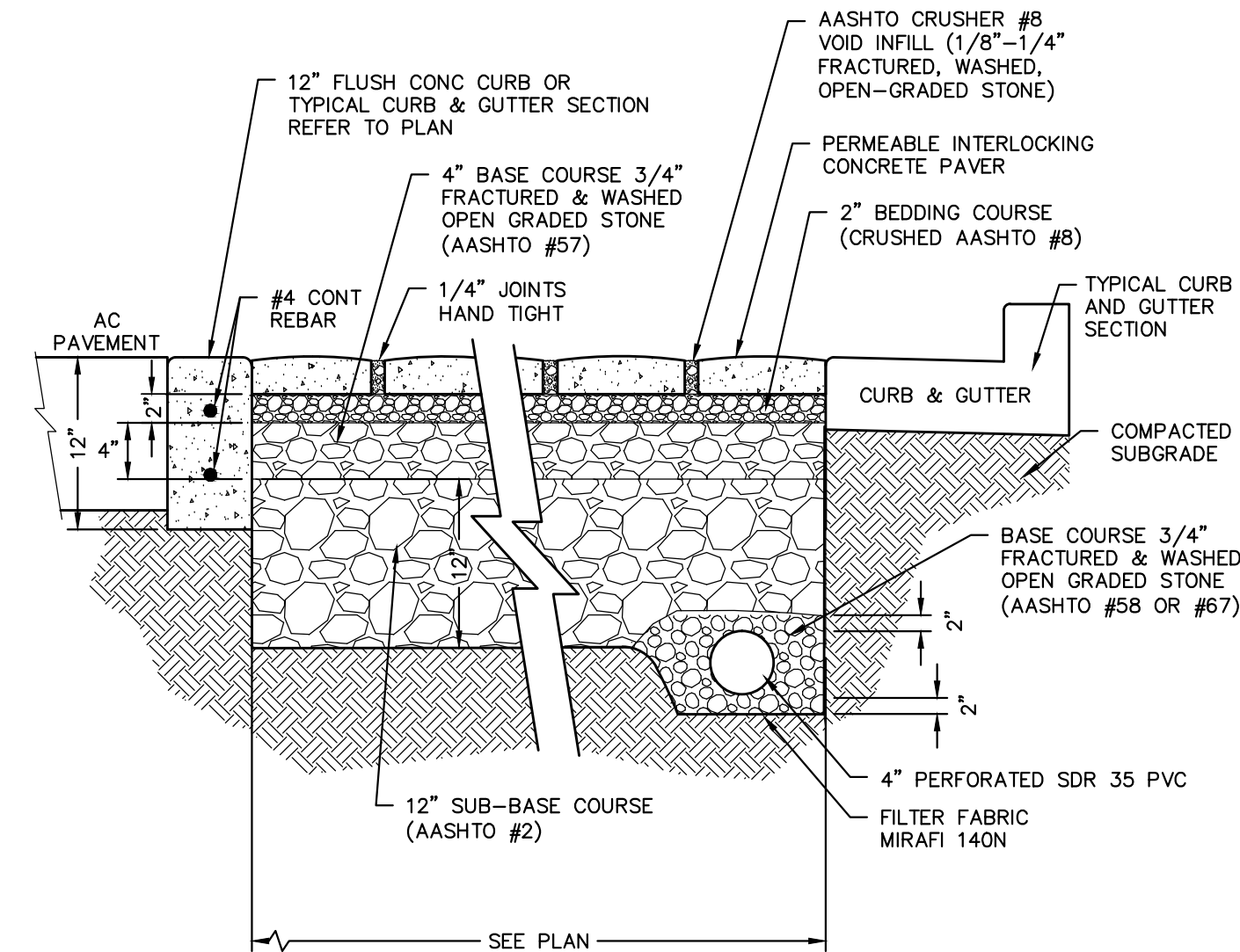

PERMEABLE INTERLOCKING CONCRETE PAVER SECTION
N.T.S.

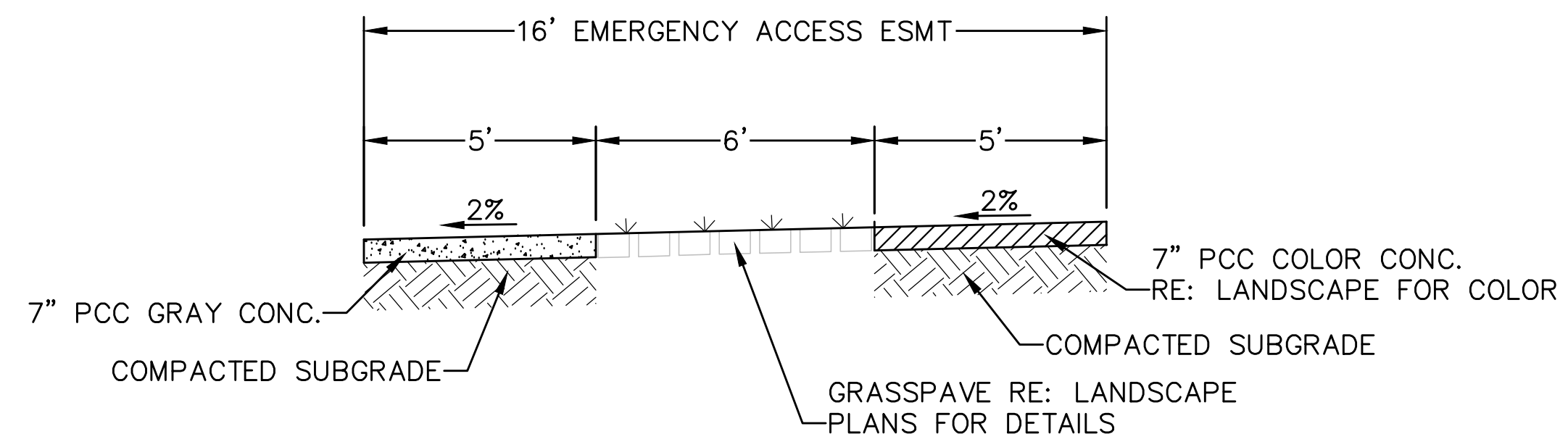

FIRE ACCESS WALK
N.T.S.

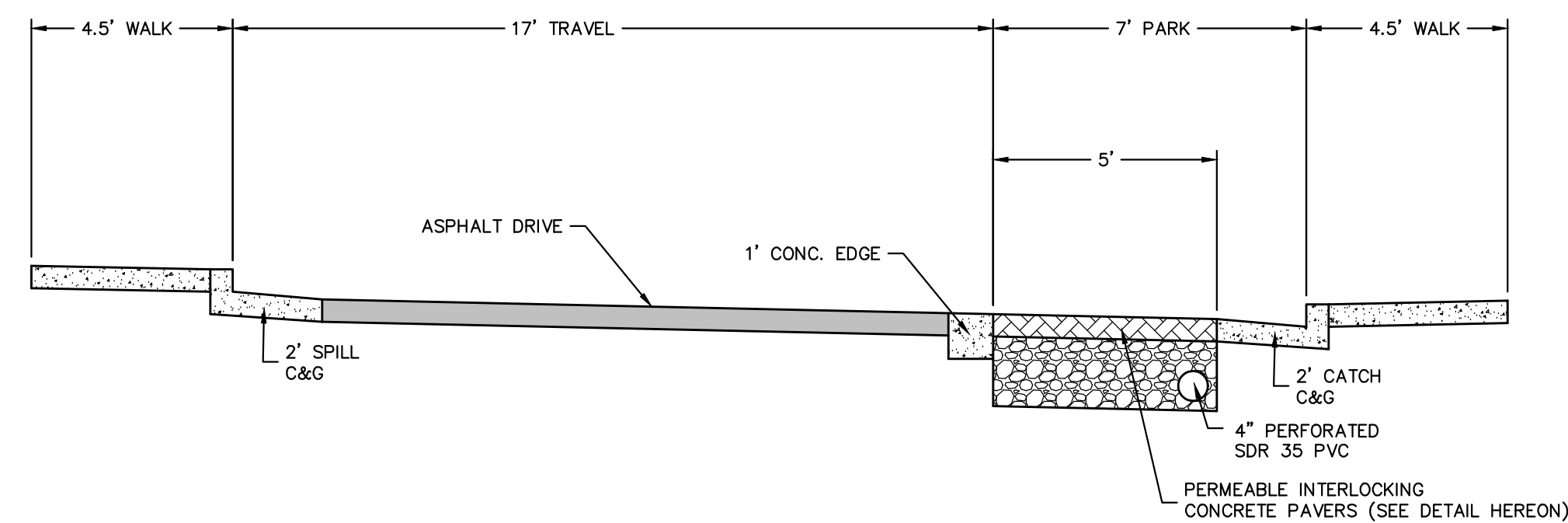

PRIVATE DRIVE TYPICAL SECTION
N.T.S.

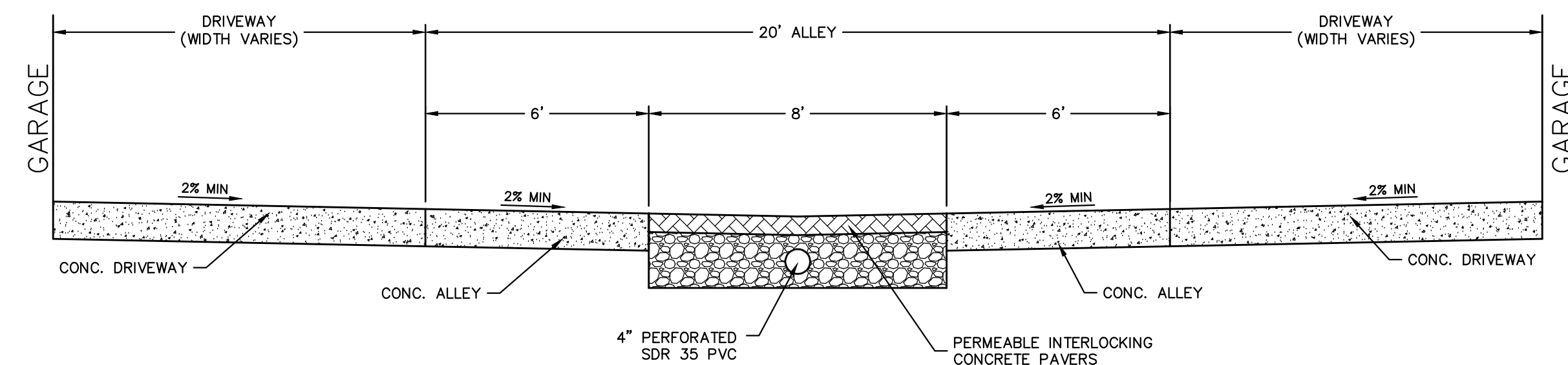

PRIVATE ALLEY TYPICAL SECTION
N.T.S.

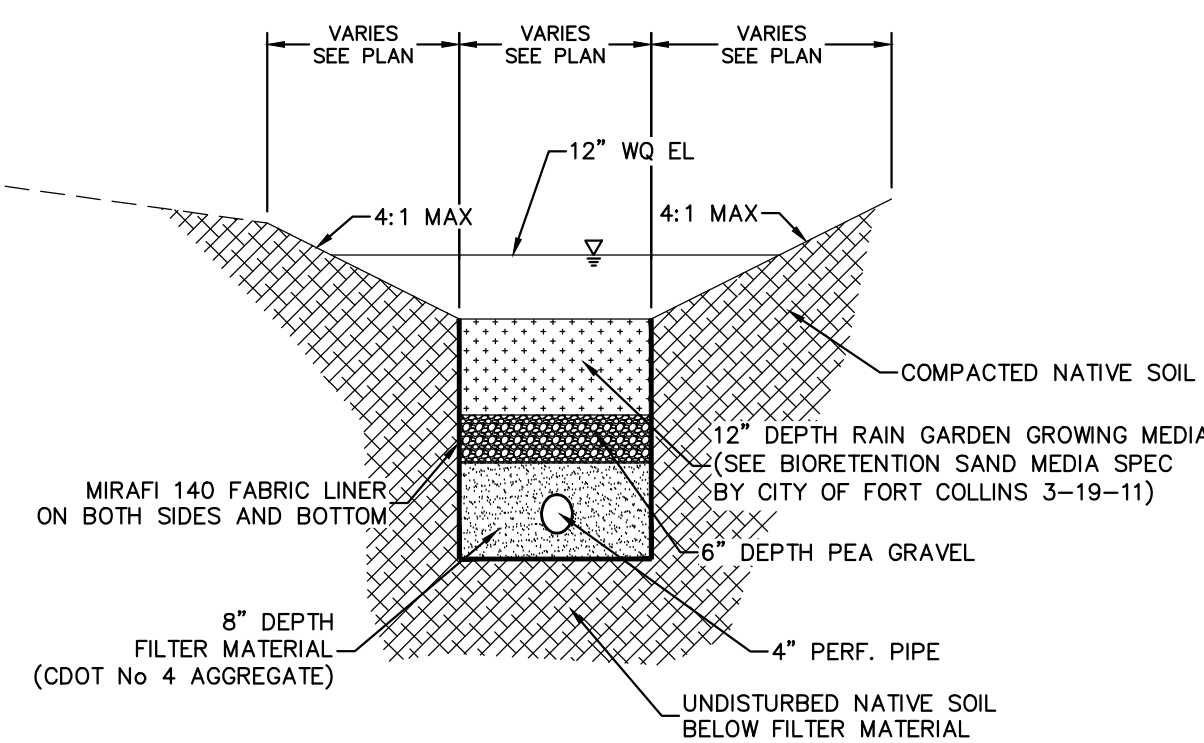

RAIN GARDEN TYPICAL SECTION
N.T.S.

CALL UTILITY NOTIFICATION
CENTER OF COLORADO
811
CALL 2-BUSINESS DAYS IN ADVANCE
BEFORE YOU DIG, GRADE, OR EXCAVATE
FOR THE MARKING OF UNDERGROUND
MEMBER UTILITIES.

CITY OF FORT COLLINS, COLORADO
UTILITY PLAN APPROVAL

APPROVED:	CITY ENGINEER	DATE
CHECKED BY:	WATER & WASTEWATER UTILITY	DATE
CHECKED BY:	STORMWATER UTILITY	DATE
CHECKED BY:	PARKS & RECREATION	DATE
CHECKED BY:	TRAFFIC ENGINEER	DATE
CHECKED BY:	NATURAL RESOURCES	DATE

**PRELIMINARY
NOT FOR CONSTRUCTION**

1218 W. Ash, Suite A
Colorado, 80502
Webster Group
Phone: (970) 874-3303
Fax: (970) 874-3303
INTEREST CONSULTING GROUP

PREPARED FOR
HABITAT FOR HUMANITY
4001 S. TAFT HILL ROAD
FORT COLLINS, CO 80525
PHONE: 970.223.4522

PROJECT NAME
HARMONY COTTAGES
DETAILS

DATE: 01/20/16
SCALE (H): N/A
SCALE (V): N/A
DESIGNED BY: SD
CHECKED BY: RA

PROJ. NO. 1255-028-00

5 OF 5

COMMENTS FROM HARMONY COTTAGES NEIGHBORHOOD MEETING

DECEMBER 3RD 2105

- The "meeting" felt very much like no one wanted anyone's input - done deal. TOO MUCH in a very small space.
- We are very concerned with the amount of buildings in a small space. Existing home values will decrease. Entrance onto harmony will create even more traffic & safety issues. Meeting was misrepresented in the letter, it was not represented as an "open house" forum. Concerns in regards to maintaining the integrity of the neighborhood - i.e.: HOA, etc. Existing neighborhood has very high standards. WORRIED!
- Thanks for having such a nice meeting. Lots of good info. Project looks good.
- HUGE traffic concerns, dangerous intersections - too many units in an already congested area - will use existing roads increasing dangerous traffic in neighborhood!
- Outer Roads Harmony & S. Taft. Have so much traffic, worried about safety for kids, intersection borders county area, no sidewalks on E. Side or West Side. Not a Logical place for these homes.
- Make intersection at Harmony and Taft more pedestrian friendly.
- Traffic flow, as they can't go left on Harmony. All traffic trying to get through left will go through our neighborhood. Speeding cars will cause a more dangerous environment for children, pets, and families.
- 1. Two-story homes much too close to existing houses on Lookout Lane. 2. Too many vehicles- 92 for that size area. 3. Our property values will be very adversely effected.
- Not enough parking with having kids whom drive. Will the people that move in there keep it up? HOA In 30 years will their kids or whoever else going to keep it up?
- Our house values are going to go down! Thanks a lot.
- What's estimated time of construction? Will it be in phases? Will a family be designated before build starts?
- Believe the annual income on Habitat chart is false/ misleading.
- TOO MANY UNITS PROPOSED FOR THIS SITE. Lack of support for low income families to access basic services 1. no access to bus. 2. no grocery within walking distance. 3. no shopping.
- THERE IS ALREADY AN ABUNDANCE OF LOW INCOME HOUSING WITHIN 1/4 MILE OF THIS INTERSECTION. LACK OF BUFFER BETWEEN EXISTING HOMES THAT WILL BE ADVERSELY AFFECTED.

- Harmony & Taft ALREADY OVERBURDENED WITH TRAFFIC DUE TO POOR PLANNING. LOOKOUT LANE ALREADY USED AS WAY AROUND INTERSECTION. See Taft between Harmony & Horsetooth lots of money spent to achieve no relief in vehicle traffic. One lane each way.
- Concern with traffic and safety. 1. Too many cars going too fast 2. no better place to enter the site but there are too many houses proposed to enter the site.
- Our home values will go down
- I love the playground and green spaces very family friendly
- Need 2 entrances and exits
- Green court is a great idea
- Looks like a real neighborhood
- I like the look of separated duplexes
- All schools are already overcapacity you will be bringing in children to schools that cannot maintain their success with the addition of so many families
- Concern with traffic increase on Harmony close to major intersection
- Kids and busy street
- Geographically isolated from resources (employment, stores, etc.)
- 1 transportation bus system nearby
- Bad bad idea
- Impact on schools
- Traffic at Harmony and Taft already very problematic and dangerous. Cannot support traffic of 48 more dwellings- wrecks occur regularly in the general area. No nearby grocery stores to support. School right down the street dangerous to kids and to traffic
- Too many buildings in this small space. No buffer between existing neighborhood & this will kill our home property value.
- School impact? Traffic will be unsafe and congested
- Home values will decrease in nearby neighbors
- Concentration of low income housing is an idea stuck in the 60's it has never worked
- I love the individual roofs
- The intersection with Harmony and Taft is extremely problematic, in part due to just 2 way street (Taft) between Horsetooth and Harmony. There are major squeeze plays with this area routinely. Very bad situation for traffic in adding 48 additional units at this location.
- Not enough street parking
- Bad design, bad left turn design- traffic will increase on Lookout Lane.

- Ditto concern about traffic onto Harmony (Exit onto S. Taft Hill would be worse morning and evening rush)
- You have to put an ingress/ egress on Taft Hill Rd. If you don't our street Lookout Lane will be used to get around to get onto Taft Hill Rd.
- Concerned about traffic increasing on adjacent neighborhood. Too many cars coming and going.
- Concerned about Traffic in the adjacent neighborhood. Cars cutting thru neighborhood rather than waiting to turn left off of W. Harmony.
- Site plan seems over built, consider reducing # of units to increase separation distance from adjacent homes back of lot lines.
- Impressive design- like the green space
- How do children walk/ bus to school?
- Speed limit on Harmony?
- Only one entrance/ exit for 122 people (2.53 per household)
- Drainage
- Not near any employment offices that people would work
- Traffic increase in our neighborhood
- Dangerous turning west onto Harmony
- We didn't want it then and we don't want it now
- What about our real-estate values
- Too much traffic for all these kids safety
- Harmony U turns

Harmony Cottages Neighborhood Meeting Summary

Date: February 18, 2016

Facilitator: Patsi Maroney (City of Fort Collins – Neighborhood Services)

Presenters: Clay Frickey (City of Fort Collins – Planning Services)
Martina Wilkinson (City of Fort Collins - Traffic Operations)
Russ Lee (Applicant)
Kristin Candella (Applicant)
Greg Fisher (Applicant)
Sara Coutts (Applicant)
Matt Delich (Applicant)
Skylar Brower (Applicant)

City Presentation Summary:

- This is the second neighborhood meeting designed to follow up from first neighborhood meeting and address concerns
- Next step is public hearing
- Current submittal has addressed emergency access, traffic, setback concerns
- City is aware of traffic issues and has adjusted signal timing at Harmony and Taft Hill to reduce cut through traffic in the morning

Applicant Presentation Summary:

- Applicant team has worked hard to address main concerns identified at first neighborhood meeting
 - Habitat program
 - Impact of product
 - Density
- Habitat serves important niche and builds community through home ownership
- The architecture has been designed to integrate into community and will be high quality product
- Impact of product reduced
 - Landscaping along Taft Hill and Harmony
 - Turf along property line
 - Shifting houses north
 - Sidewalks and fencing
 - 42% of site is open space

Questions and Answers

Question: How will the ingress and egress to the site work? Will it be limited to right in, right out only?

Response (City): The ingress and egress to the site will allow for left turns in and out. The left turn out will occur in 2 stages.

Question: What is a 2 stage turn?

Response (City): It means the vehicle turning left will first enter into the center lane and then merge into traffic from there.

Question: It's my understanding that the Habitat for Humanity project at Rigden Farm was part of the original design and part of the HOA. Since this proposed development won't be a part of our HOA, how will it be regulated?

Response (Applicant): Actually, the Habitat project at Rigden is part of a sub-association that came later and wasn't part of the original design. For this development, the owners will form their own HOA. We are working with a management company right now on developing the HOA.

Question: During the presentation on traffic you mentioned there will be 1 car per minute entering and leaving the site. Is this based on the 1 car garage shown for each building or is this based on the number of units?

Response (Applicant): Actually, there will be two parking spots per home, 1 garage spot and 1 in front of each house.

Response (City): We base traffic predictions on the number of units in the development. We know, for example, that single-family homes tend to generate a certain amount of trips per day and use that to predict the estimated traffic impact. At peak hour in the PM, we estimate that the development will generate 54 trips.

Question: For the light at Seneca, I see problems coming out of my neighborhood. I already have a difficult time getting out of my neighborhood. People will go on other streets to avoid the traffic.

Response (City): We look at delays at intersections at peak hours and we have minimum Level of Service standards. We grade Level of Service like we do for grades at school. The Level of Service for that intersection will be a C or D, which is acceptable by City standards.

Question: I live on Silvergate and have a terrible time getting out during the day now. This development will impact us. You say this won't cause cut through traffic but since we're experiencing cut through traffic right now what will you do to stop it?

Response (City): Traffic delays are going to happen and we will do our best to manage the signal timing at Harmony and Taft Hill to prevent cut through traffic. We also have the Neighborhood Traffic Mitigation Program to help your neighborhood out if you have lots of cut through traffic. We can

conduct speed studies and studies of trip origins and destinations to see how traffic is impacting your neighborhood. Based on the results of the study, we might look in to installing speed bumps or signs to slow traffic down. The nice thing is that this program is funded by the City so you will not have to pay for any of these improvements.

Question: What is the baseline for the Level of Service at Harmony and Taft Hill?

Response (Applicant): It is a C right now and will be a C or a D with this development.

Question: Is the water quality feature detention or retention?

Response (Applicant): Neither, the water will go to a detention area off site. We will be treating for water quality with Low Impact Development. The water on the site will drain within 24 hours, the water goes through fast.

Question: Have you looked at the hydrology for the site? There are problems with water in basements in wet years right now. I'm concerned that digging basements for these homes will impact our neighborhood. I want to make sure that flows won't go to our neighborhood.

Response (Applicant): We've done 2 geotechnical studies, one in 2006 and one last year. Neither showed a water table within 15'. We won't do many basements due to the soil. If we do basements, they will be in the northwest corner of the site.

Question: Since traffic is at a C or D level right now, what are we doing before this project goes in to improve traffic? Have you considered a right turn on northbound Taft Hill or an access point for this development on Taft Hill?

Response (City): Yes, we have considered both. We wouldn't allow an access point on Taft Hill since it would be too close to the intersection. We have also looked at a right turn lane on northbound Taft Hill but would prefer to do that improvement as part of the project to widen Taft Hill to 4 lanes. The City prefers to do projects that are a part of a larger capital project rather than small pieces.

Comment: The way to solve the Taft Hill traffic problem is to make Shields 4 lanes since it goes all the way through Loveland. The thing is with this site is that if it were any good, we would have a bank or some other better use on it by now. I'm concerned about the safety of kids. Right now, kids can't go anywhere because the sidewalks are incomplete along Taft Hill north of here. There's been no consideration for kids at the intersection. You should find a different property that is better for kids. There's no grocery store, schools, or transit nearby. Plus I've seen more and more cars on Taft Hill over the past 10 years and this isn't going to help. Also, this will hurt the property values in our neighborhood, which means the City will lose tax revenue and I don't think the City wants that.

Comment: Taft Hill being 2 lanes is a problem right now so what is the hold up in getting it widened? I also don't like the left turn situation onto Harmony from the development.

Question: How wide will the streets be in the development?

Response (Applicant): The streets will be private with parking on one side of the street. **The private drive is 24' wide with parking on the north side of the drive only.**

Question: What will the value of the cottages be?

Response (Applicant): We're not sure yet but recent appraisals of our single-family homes elsewhere have been at \$250,000. These homes have seen an appreciation of 20%.

Question: Will current occupancy ordinance apply to this development?

Response (Applicant): Yes, we will abide by the occupancy ordinance.

Question: How will kids get to school and access the school bus? What school will these kids go to?

Response (Applicant): We will follow up with you on that. **Access is designed to use the under pass across Harmony to the south. The site is within the walking zones of Johnson, Webber and Rocky. Rocky students would cross at crosswalk at Harmony and Taft. If bussing was needed it would be provided on east bound Harmony, most likely at the bus stop located to the north of this site and would be provided for Rocky only.**

Response (Principal): The kids in this development will go to Johnson Elementary.

Question: The current conditions for turning out on to Harmony from Greengate is a challenge. Could you adjust the signal timing at the Harmony and Taft Hill intersection to allow for more time for residents to turn on to Harmony?

Response (City): We will follow up with you at a later date.

Question: Where will guests park?

Response (Applicant): Each unit has an extra parking space and there will be parking on the north edge of the private street.

Question: Is the applicant seeking any variances?

Response (Applicant): Yes, normally the required setback along arterials is 30'. We are looking for a modification to allow the buildings to be 25' from the curb. We could comply with the 30' setback but would have to change unit types from duplexes to triplexes to make that work.

Question: Is the site plan contingent on the modification being granted? What happens if you don't get approval for that?

Response (Applicant): Yes, we would have to change to triplexes **or 4-plexes** if we don't get the modification.

Question: Could you walk us through how school buses will drop off kids on Harmony? Will buses stop on the wrong side of Harmony and force kids to cross the street?

Response (City): We're not sure on the route but I will follow up with you. The bus routes are determined by Poudre School District. Poudre School District does not allow crossover on arterial streets.

Response (Applicant): Development is within walk zone for all schools. Bus to Rocky would be on the proposed east bound Harmony bus stop.

Question: Has there been a study done on school buses backing traffic up?

Response (City): This is included in our traffic analysis. We include projected and existing buses in this analysis.

Question: How does ownership work? Can property owners turn these into rental properties?

Response (Applicant): No, they must be owner occupied and they come with a 20-year affordability term.

Comment: Most children will walk to school so there may not be bus service there.

Comment: Children will cross Harmony without using a crosswalk.

Comment: I have a comment on the impact to schools. I am worried about the capacity of schools in the area. These areas need to be attractive to families and the quality of our schools helps make this area attractive. Pushing schools over capacity will lower the quality of our schools.

Response (Applicant): I don't have a firm response to that comment but Poudre School District is routed on all development projects and they have not commented on this proposal.

Comment: Poudre School District may not care. What difference does it make if kids go to one school or another?

Response (Principal): Johnson is at 75% capacity right now.

Question: Greengate and Harmony has a turn lane. How will this development impact our access to that turn lane?

Response (Applicant): This won't impact Greengate's access.

Question: When they are turning left will they go into the median or the turn lane?

Response (Applicant): They will queue in the center turn lane before Greengate.

Comment: I have a backyard that faces Taft Hill and our backyard and patio are not attractive because of all of the traffic noise.

Question: Will the HOA have the same standards as our HOA?

Response (Applicant): We are still developing the HOA so we are not sure.

Question: Will the development share a fence with the abutting properties or will you build your own fence?

Response (Applicant): There will just be the existing fence.

Question: So then the HOA is on the hook if something happens to the fence? That doesn't seem right.

Response (Applicant): That's usually how it works. **Our HOA will share the expense of agreed maintenance of the fence.**

Question: I am curious about the sweat equity you talked about during the presentation. How long will construction take?

Response (Applicant): It depends on funding and volunteers but it could potentially take 6 years.

Comment: We've heard a lot of great stories about opportunities but we want answers to our questions.

Response (Applicant): **We work hard on this every day, these things are a big concern to us, too.**

Comment: That's what you said last time.

Response (Applicant): **We need to look at some of these things in greater detail.**

Response (City): Development is responsible for installing any needed sidewalks. We need to look at the signal timing and crosswalks and it will deal with pedestrians getting across Harmony safely.

Question: How will kids get to Johnson?

Response (Applicant): **The underpass across Harmony.**

Comment: We shouldn't have to worry about our own fence. You should put in your own fence.

Question: Will the single-family homes be 1 story or 2 stories?

Response (Applicant): The single-family homes will be 1 story and the duplexes will be 2 stories.

Comment: The most direct way to get to Johnson is to cross through the greenbelt. We would like to see the kids go some other direction.

Question: How much right of way is required to get Taft Hill to 4 lanes? Will we lose any trees?

Response (Applicant): The proposed sidewalk is located to be sited appropriately based on the Taft Hill expansion. The trees shown are behind the sidewalk so they will work with the road's expansion.

Question: So in other words we could have a construction site for 5-6 years, what is the process and timing for installing the landscaping?

Response (Applicant): The green belts and roads will be built right away following by the individual lots. **Roads and landscaping that would not be affected by house construction will be installed right away. House construction will be at least 6 years.**

Question: How about the street trees?

Response (Applicant): Yes, **street trees will be installed.**

Question: As for the home values, what were the values before the Habitat homes were built in Rigden and what were they after?

Response (Applicant): **Recent appraisals of our single-family homes have been at \$250,000. That is an appreciation of 20%.**

Question: I appreciate everyone's concerns so far. Pedestrian safety is a concern for me. What happened to the trees on the south edge of the development?

Response (Applicant): We will look at trees on the property line. **Trees have been added to south property line.**

Comment: This is an odd property in that there are nice homes and low income housing nearby.

Comment: South Taft Hill becomes a drag racing strip. The entrance shown on Harmony will have lots of fast traffic, too.

Question: Since this will be a construction site for 6-7 years, where will volunteers park? This is not a good site.

Response (Applicant): **Parking for volunteers will be available on site and at the Habitat Restore on northwest corner of Harmony and Taft.** To respond to some of the construction questions, most of the intensive construction will be done at the beginning. This includes putting in the roads. We will also place fences early on to increase safety.

Comment: I have some words of support for the project. My father is a Habitat volunteer in Columbus, OH and he always comments on how these developments improve the neighborhoods around them. I'm a school teacher and I have kids that live in Habitat homes. Habitat homes increase their housing security, which results in improved school performance. I have fellow school teachers that have applied to live in a Habitat home and this provides a homeownership opportunity for them. Plus, students help build some of these homes and this gives them something to build their pride.

Question: Everyone here loves Habitat but not here. What is the process for the remainder of the project?

Response (City): The next step is to incorporate this feedback into the proposal. After that, the project will go to a public hearing for approval. Everyone who signed in will be notified via e-mail of this meeting. Every property owner within 800' of the development will also receive a letter in the mail two

weeks ahead of the scheduled hearing date. The decision maker is a hearing officer, which is a land use attorney from outside the community. At that meeting, the applicant and City will give presentations on the project and the City will provide a recommendation to the hearing officer. This meeting will open to the public to comment on the project and the hearing officer will take your concerns into consideration when making their decision. After the hearing, the decision maker has 10 business days to render a decision. Once the hearing officer renders a decision, everyone who provided testimony at the hearing will receive a notice of the decision. Those who are in the notification area or provided testimony can appeal the decision within 10 business days to City Council.

Comment: I can't even sit and enjoy my backyard that sits along Taft Hill due to all of the traffic. My living room and office are also quite noisy. Traffic also cuts through our neighborhood all the time.

Response (City): We want to talk to you in further detail and make sure we are monitoring the neighborhood at the right times. We want to address these issues.

Comment: People don't want to wait at the light and that is what causes a lot of the cut through traffic.

Response (City): We are trying to address that and thought it was going well. We need to take a closer look.

Comment: I would like to say that having experience with developers they say one thing and do another. This seems like a great idea just not here. Property values went way down in 2008 and we're worried about property values going down now and losing all of our retirement money.

Question: How can we help Habitat find a different property?

Question: What is the maximum length of a cul de sac in Fort Collins?

Response (Applicant): 660'.

Question: What is the distance from the entry to the end of the cul de sac at the southwest end of the site?

Response (Applicant): **Our street is a private drive, not a cul-de-sac. We have a second point of access less than 660'.**

Question: Is it big enough to do a turnaround for a bus?

Response (Applicant): I haven't used a bus turning template on this cul de sac so I am not sure. **PSD bus will use east bound Harmony.**

Comment: I appreciate everyone's concerns. I work at Poudre High School and I teach math. I've lived in the neighborhood for 15 years and had asked my realtor about this project since there was a rumor that there was low income housing coming to our neighborhood and what it would do to property values. He told me that our property values won't go down. I build homes in our geometry class and that has changed my perspective on Habitat homes. I'm a numbers guy so I'm not making this up, 1/3 of my class

has said they wish they could live in homes like the ones we build. In my opinion, we have the best neighborhood in Fort Collins but if we open up the picture a little bit, the trailer park to the north of us hasn't impacted our property values. I'm scared for the kids, too, but it looks like they have done a good job addressing our concerns. 1 car a minute will piss me off when I'm trying to get out of the neighborhood too but I'll deal with. It's also very hard to get land in Fort Collins. New teachers can't afford Fort Collins so I think we have to give a little on this project.

Comment: So with the decision maker that means that one person will decide whether this project happens or not.

Response (City): That's why we have a public hearing so the community can provide testimony to influence the decision. The decision maker can choose to attach conditions to the project's approval to address concerns of the community.

Comment: I don't like the decision maker scenario, City Council should vote on it.

Question: Has Habitat ever been denied in Fort Collins?

Response (Applicant): No.

Comment: I hear sirens all the time and I live 5 houses off Harmony. We should also look at boat traffic and emergency vehicles in the summer. This causes a lot of congestion. I'm concerned about the safety of kids in the summer.

Response (City): We will look into more enforcement for traffic on Harmony.

Question: How far are duplexes away from traffic?

Response (Applicant): The closest one is **39' from Harmony** and the unit furthest away is **52' from Taft**.

Comment: I thought the minimum offset was 25'.

Response (Applicant): It's **5' for side yards**.

Question: Will there be windows on both sides of the houses?

Response (Applicant): Yes.

Comment: So the people living there can look right into our backyards, then.

Question: Shouldn't they locate the development in east Fort Collins due to all of the development out there?

Response (Applicant): Securing property in Fort Collins is difficult. I've been looking for a year for a lot for a Poudre School District home and I haven't been able to find one.

Question: Was this property purchased by HUD?

Response (Applicant): No.

Question: What is the cost of the water taps? I thought water taps were really expensive.

Response (Applicant): We're getting our water from City Utilities, not the South Fort Collins Loveland Water District.

Question: Who pays for the taps?

Response (Applicant): The developer pays for the taps.

Question: What about water pressure? I have pretty low water pressure right now and so I am concerned about this development impacting my water pressure.

Response (Applicant): Utilities will ensure there will be sufficient water pressure.

Question: I have a question about the covenants. So an attorney will write the covenants, but when will they be available? Will they be available before the hearing?

Response (Applicant): Covenants are based on our selection process to prospective owners so we probably won't have the covenants ready by the hearing. As a developer we stick around so if there are issues we can step in.

Comment: I just wanted to speak for a moment on something that happened recently. A car had missed the turn at Greengate and ran through two fences and into a house. We need to address the traffic issues in this area.

Comment: The car came within 10' of a woman's pillow.

Question: 48 units seem like awfully high density. Have fewer units been considered? Is there a possibility to reduce the number of units?

Response (Applicant): Density is there so they can provide an affordable product. We looked at many iterations but the density has not changed much due to affordability.

Question: How will you address all of the questions?

Response (City): I'll type up all of the notes and send them out to everyone who gave us their e-mail. We'll also make sure to address these comments with the proposal that goes to the hearing officer so they will be addressed at the public hearing.

Question: Does Habitat own the property?

Response (Applicant): No, the developer owns the property and we will buy it back **lot by lot**.

Question: Can you e-mail your staff report as well?

Response (City): Yes.



How Habitat Works

Habitat for Humanity brings people together to build homes, communities and hope. All are welcome to help with the work, regardless of race, religion, age, gender, political views or any of the other distinctions that too often divide people.

This grassroots effort is made possible through the generous donations of materials, funds, and labor from members of the Fort Collins community. With this leveraging of resources, Habitat is able to help partner families earning 35-60% of the area median income to build and buy their own home. For example, a family of 4 earning between \$27,230 and \$46,680 qualifies for the program income-wise.

Partner families pay a 0% interest fixed-rate mortgage payment that does not exceed 28% of their income and this helps to build more homes. If the first mortgage, the maximum affordable mortgage over 30 years, is less than the appraised value of the home then Habitat places a second deed of trust. This "silent second" on the home represents the difference. It is called a "silent second" because the homeowner pays no payments on this amount but, in the event the homeowner decides to sell the home, they would still owe what remains on their first deed of trust and also this "silent second." The second deed of trust would be paid back upon sale of the home to allow Habitat to build more homes.

Habitat homeowners also contribute \$1,500 toward closing costs and up to 500 hours of "sweat equity" building their home and those of other families.

The lasting, generational impact of Habitat for Humanity is well-documented and includes educational and job attainment, health and wellness, and a sense of security and confidence in managing finances.

Partner Family Qualifications

To be eligible to purchase a Habitat home, families meet the following four criteria:

1. Residency - Live or work in Fort Collins (or surrounding rural areas), are a US citizen, or a legal permanent resident
2. Need of Housing- Housing is inadequate, unaffordable, unsafe, or not stable
3. Ability to Pay – Consistent income at 35-60% AMI, save \$1,000 down payment
4. Willingness to Partner - Committed to giving 250-500 hours of "sweat equity" building homes or through other volunteer activities, including working at the ReStore. Sweat equity activities can be modified based on ability.

Meeting these minimum criteria helps ensure the success of families.

Fort Collins Habitat for Humanity (FCHF) provides families the necessary resources to be successful homeowners. The Homeowner Services Manager facilitates family selection and then, after selection, provides case management, ongoing support services and education, and consultation throughout the term of the home loan. With a total of 60 homes in Fort Collins, there has only been 1 foreclosure or less than 2% of loans.

Prior to closing on their homes, partner families participate in a series of 6 homeowner education classes including the following: Homebuyer Education through Neighbor to Neighbor, Legal Aspects of Homeownership, and Financial Management. They also are required to participate in the 9-week Financial Peace University program

Green, Energy Efficient Homes

Each home is carefully designed to be aesthetically pleasing as well as energy efficient. We have built single-family homes, duplexes, and multi-family developments throughout Fort Collins.

Fort Collins Habitat for Humanity has built multiple LEED Gold certified homes and continues to build to these standards although not every home is certified. LEED standards have been incorporated into the design and construction, with energy efficiency components of Energy Star and much more.

Our homes include the following:

- * Low VOCV paints, finishes, carpet
- * Upgraded Low-E Windows
- * Programmable Thermostats with Limits
- * Energy Star Rated appliances
- * CFL bulbs
- * Insulated Foundation
- * Upgraded HVAC
- * Upgraded building shell with spray foam insulation
- * Low flow shower heads and toilets

Another component of green building we are committed to is providing homeowner education about efficiency usage. This is included in the walk-through upon completion of the home.

How the Program Works

Fort Collins Habitat for Humanity builds homes in partnership with selected and qualified, modest-income households.

Habitat homeowners:

- Contribute a minimum of 250-500 hours of "sweat-equity" building their homes, the homes of others, and preparing to be successful homeowners.
- Consent to a criminal background check, sex offender registry check, credit check, and the Specially Designated Nationals and Blocked Persons check via the US Treasury.
- Complete homeowner education classes including:
 - Homebuyer Education Class provided by Neighbor to Neighbor
 - Financial Peace University, a nine week study on personal financial fitness and management
 - How to be a Good Neighbor
 - Home Maintenance
 - Legal Aspects of Homeownership
 - Media and PR Training
- Pay back a no-interest mortgage through affordable payments based on 28% of a household's gross monthly income.



Program Qualifications

Homeowner applicants must meet the following criteria:

1. **Residency:**
 - Live or work in Fort Collins or the surrounding rural areas.
 - Are a US citizen or a lawful permanent resident.
2. **Have a need for housing:**
 - Unable to qualify for a conventional or government assisted loan, or
 - Live in overcrowded conditions, or
 - Live in unsafe housing, or
 - Housing is temporary or transitional, or
 - Rent is more than 30% of gross income.
3. **Willingness to partner with Habitat:**
 - Complete classes once selected.
 - Complete "sweat-equity" volunteer hours prior to closing on home.
 - Save \$1,500 toward closing costs.
4. **Ability to pay for the home:**
 - Meet the income qualifications.
 - Currently able to pay bills on time.
 - Have had no bankruptcy in past 2 years.
 - Have had no foreclosure in past 3 years.
 - Have no outstanding liens or judgments.
 - Complete mortgage application and fulfill all underwriting requirements. *



Income Qualifications

Applicants must have a steady income history. This can include income from reliable sources other than employment, such as social security. Current income guidelines are shown below.

household size	annual income	household size	annual income
1	\$19,075-32,700	4	\$29,435-50,460
2	\$21,805-37,380	5	\$31,005-54,180
3	\$24,535-42,060	6	\$33,775-57,900
4	\$27,230-46,680	7	\$35,945-61,620

household size	monthly income	household size	monthly income
1	\$1,590 - 2,725	4	\$2,453 - 4,205
2	\$1,817 - 3,115	5	\$2,634 - 4,515
3	\$2,045 - 3,505	6	\$2,815 - 4,825
4	\$2,269 - 3,890	7	\$2,995 - 5,135

* Fort Collins Habitat for Humanity operates in accordance with the Fair Housing Act, the Equal Credit Opportunity Act, and the Americans with Disabilities Act as well as ensuring compliance with all SAFE Act, Anti Money Laundering and TILA Loan Originator qualification requirements.



Please direct questions to Theres Bain, Homeowner Services Manager at 970-488-2605