

Conceptual Review Agenda

Schedule for 4/04/19
281 Conference Room A

Thursday, April 4, 2019

Time	Project Name	Applicant Info	Project Description	
9:30	The Tramp About CDR190026	Brandon Spain 541-326-2487 thetrampabout@gmail.com	This is a request to convert an existing vehicle service and maintenance facility into a restaurant at 429 N College Ave (parcel #9711114005). Access is taken from N College Ave to the east. Twelve off-street parking spaces are proposed. The property is within the Community Commercial - Poudre River (CCR) zone district and is subject to Administrative (Type 1) Review.	Planner: Kai Kleer Engineer: Morgan Uhlman DRC: Brandy BH
10:15	6629 S College Ave CDR190027	BJ DeForge 970-669-8220 bj@hauserarchitectspc.com	This is a request to convert a portion of the building at 6629 S College Ave to marijuana cultivation (parcel #9614119002). Access is taken from S College Ave to the east. The property is within the Limited Commercial (CL) zone district and is subject to Basic Development Review (BDR).	Planner: Kai Kleer Engineer: Katie Andrews DRC: Todd Sullivan
11:00	Expanding Horizons Farm CDR190028	Emma Englesby 970-658-6281 expandinghorizonsfarm@gmail.com	This is a request to convert a horse boarding facility to a year-round agricultural education facility at 2407 W Drake Rd (parcel #9728100021). Land uses may include a private school, child care, and urban agriculture which may be considered a neighborhood center pending further review. Access is taken from W Drake Rd to the north. The property is within the Low Density Mixed-Use Neighborhood (LMN) zone district and is subject to Administrative (Type 1) Review or Planning and Zoning Board (Type 2) Review pending further review of appropriate land use designations.	Planner: Clay Frickey Engineer: Marc Virata DRC: Tenae Beane

The Tramp About Restaurant

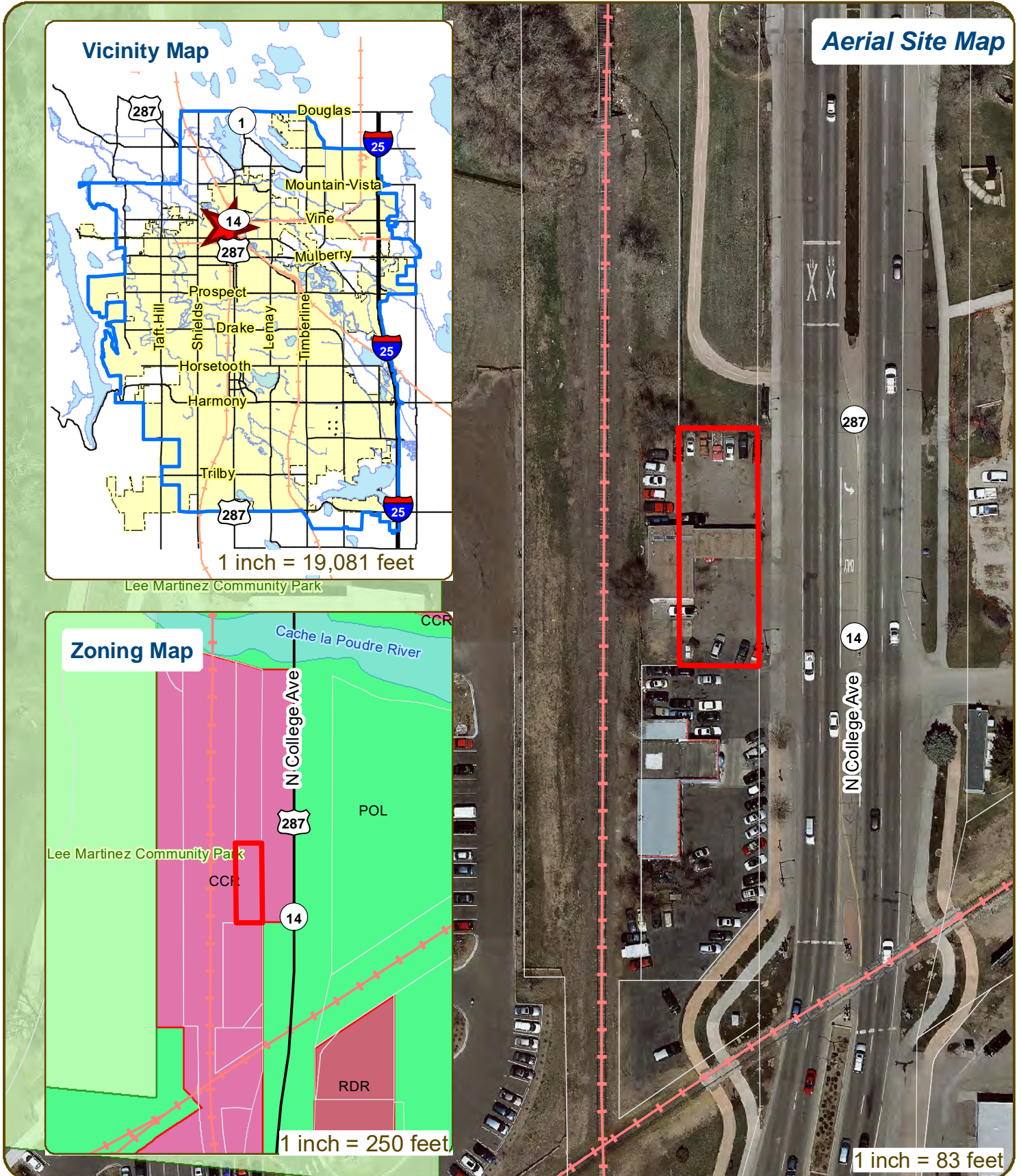

These map products and all underlying data are developed for use by the City of Fort Collins for its internal purposes only, and were not designed or intended for general use by members of the public. The City makes no representation or warranty as to its accuracy, timeliness, or completeness, and in particular, its accuracy in labeling or displaying dimensions, contours, property boundaries, or placement of location of any map features thereon. THE CITY OF FORT COLLINS MAKES NO WARRANTY OF MERCHANTABILITY OR WARRANTY FOR FITNESS OF USE FOR PARTICULAR PURPOSE, EXPRESSED OR IMPLIED, WITH RESPECT TO THESE MAP PRODUCTS OR THE UNDERLYING DATA. Any users of these map products, map applications, or data, accepts same AS IS, WITH ALL FAULTS, and assumes all responsibility of the use thereof, and further covenants and agrees to hold the City harmless from and against all damage, loss, or liability arising from any use of this map product, in consideration of the City's having made this information available. Independent verification of all data contained herein should be obtained by any users of these products, or underlying data. The City disclaims, and shall not be held liable for any and all damage, loss, or liability, whether direct, indirect, or consequential, which arises or may arise from these map products or the use thereof by any person or entity.





CONCEPTUAL REVIEW: APPLICATION

General Information

All proposed land development projects begin with Conceptual Review. Anyone with a land development idea can schedule a Conceptual Review meeting to get feedback on prospective development ideas. At this stage, the development idea does not need to be finalized or professionally presented. However, a sketch plan or site plan and this application must be submitted to City Staff prior to the Conceptual Review meeting. The more information you are able to provide, the better feedback you are likely to get from the meeting. Generally, Conceptual Review works best after a brief conversation with a representative from the Zoning or Planning Department to first establish compliance with the permitted uses under the applicable zone district. Then a sketch plan or site plan is prepared that allows staff to review and provide comments on the land development aspects of the proposal. Please be aware that any information submitted may be considered a public record, and may be made available to anyone who requests it, including the media. The applicant acknowledges that that they are acting with the owner's consent.

Conceptual Reviews are scheduled on three Thursday mornings per month on a "first come, first served" basis. One 45 meeting is allocated per applicant and only three conceptual reviews are held each Thursday morning. Conceptual Review is a free service. Complete applications and sketch plans must be submitted to City Staff no later than 5 pm, two Tuesdays prior to the meeting date. Application materials must be e-mailed to currentplanning@fcgov.com. If you do not have access to e-mail, other accommodations can be made upon request.

At Conceptual Review, you will meet with Staff from various City departments, including Community Development and Neighborhood Services (Zoning, Planning, and Development Review Engineering), Light and Power, Stormwater, Water/Waste Water, Transportation Planning and Poudre Fire Authority. Staff provides the applicant with comments to assist in preparing the detailed formal project application. There is no approval or denial of development proposals associated with Conceptual Review. The applicant will receive the comment letter at the review meeting.

BOLDED ITEMS ARE REQUIRED *The more info provided, the more detailed your comments from staff will be.*

Contact Name(s) and Role(s) (Please identify whether Consultant or Owner, etc) _____

Brandon Spain Tim Mewler

Business Name (if applicable) The Tramp About

Your Mailing Address 1609 Collins Ct Fort Collins CO 80521

Phone Number (541) 326-2487 Email Address TheTrampAbout@gmail.com

Site Address or Description (parcel # if no address) _____

429 N. College Fort Collins CO 80524

Description of Proposal (attach additional sheets if necessary) _____

Restaurant, Bar and commissary.

Proposed Use Restaurant Existing Use Service station

Total Building Square Footage 1,092 S.F. Number of Stories 1 Lot Dimensions _____

Age of any Existing Structures 61 years old.

Info available on Larimer County's Website: http://www.co.larimer.co.us/assessor/query/search.cfm

If any structures are 50+ years old, good quality, color photos of all sides of the structure are required for conceptual.

Is your property in a Flood Plain? [] Yes [] No If yes, then what risk level? _____

Info available on FC Maps: http://gisweb.fcgov.com/redirect/default.aspx?layerTheme=Floodplains.

Increase in Impervious Area _____ S.F.

(Approximate amount of additional building, pavement, or etc. that will cover existing bare ground to be added to the site)

Suggested Items for the Sketch Plan:

Property location and boundaries, surrounding land uses, proposed use(s), existing and proposed improvements (buildings, landscaping, parking/drive areas, water treatment/detention, drainage), existing natural features (water bodies, wetlands, large trees, wildlife, canals, irrigation ditches), utility line locations (if known), photographs (helpful but not required). Things to consider when making a proposal: How does the site drain now? Will it change? If so, what will change?

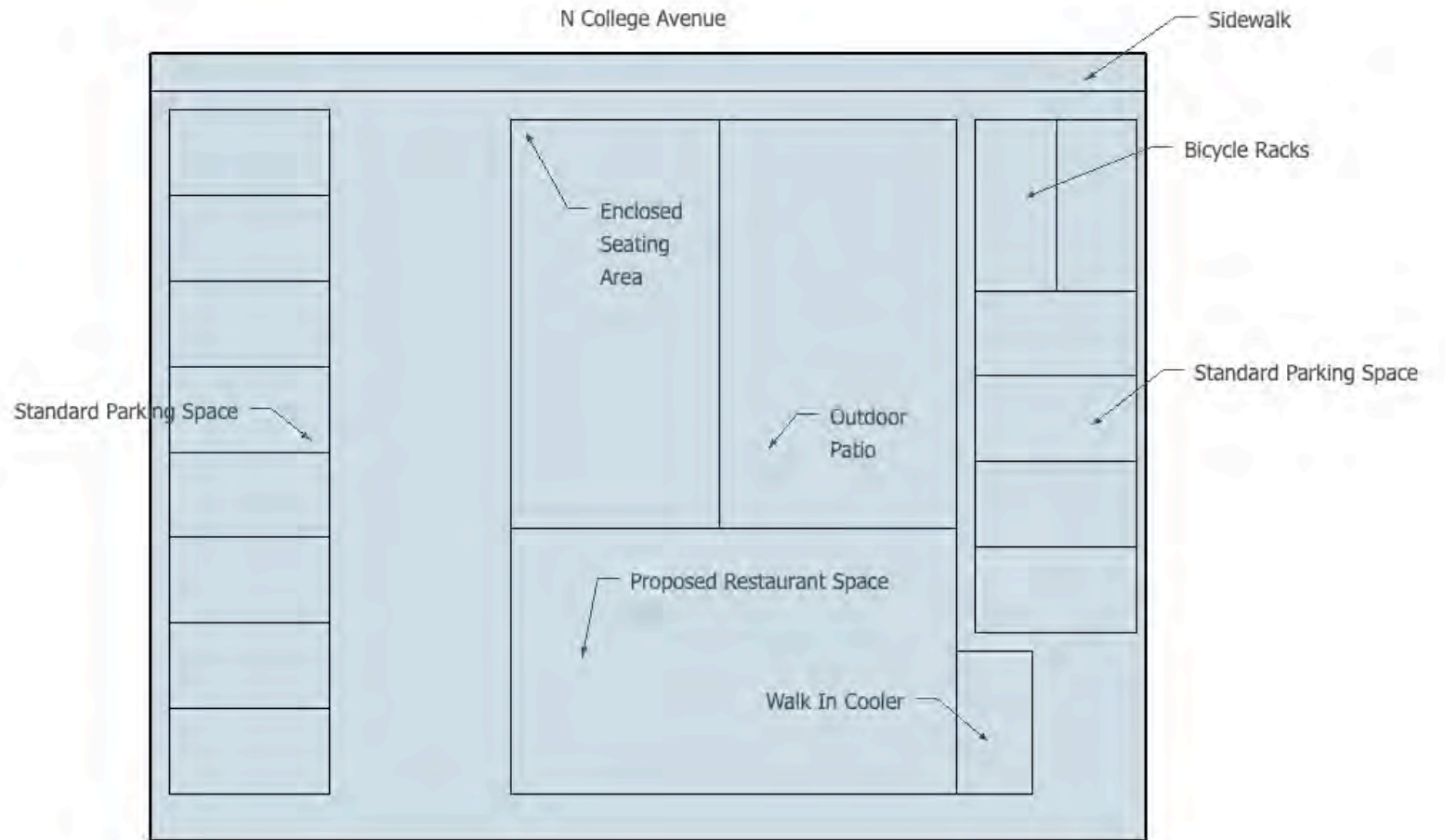



DIESEL REPAIR 484-8330

429
CHARVAT'S
AUTOMOTIVE &
DIESEL SPECIALISTS
484-8330

ELECTRICAL REPAIR & DIAGNOSTICS



The Tramp About: 429 N. College Avenue

Proposal

Tramp About is an established Fort Collins food truck that has been partnering with local breweries for four successful years. We're thankful to be apart of the Fort Collins community and appreciate the ever growing support it has shown us. In return, we too enjoy supporting our local farms by showcasing their ingredients throughout the menu.

Tramp About would like to propose building a commercial commissary kitchen at 429 N. College Avenue in order to meet the current demands of the business. It is our desire to incorporate a restaurant and bar into the build out as well in order to account for future business plans at the property. We'd like to repurpose what is now a service station into a modern and successful restaurant to provide an appealing atmosphere for River North tourists and locals to dine.

Build out Plans

- Build out inside into a functioning commissary kitchen
- On the south side of building place 8x8x15 walk-in cooler with 6x6 dry storage area
- Fence in cooler for security and esthetic reasons
- Meet with Architect to design layout of interior and outside patio
- Build out kitchen line: hood vent, six-burner, flat top, fryer and sinks
- Enclose parking awing for addition restaurant seating
- Meet parking and bicycle city requirements
- Landscape design to incorporate Colorado native and drought resistant plants
- Meet with Larimer Health Department to get approved for use of commissary

6629 S College Ave Marijuana Cultivation

Vicinity Map

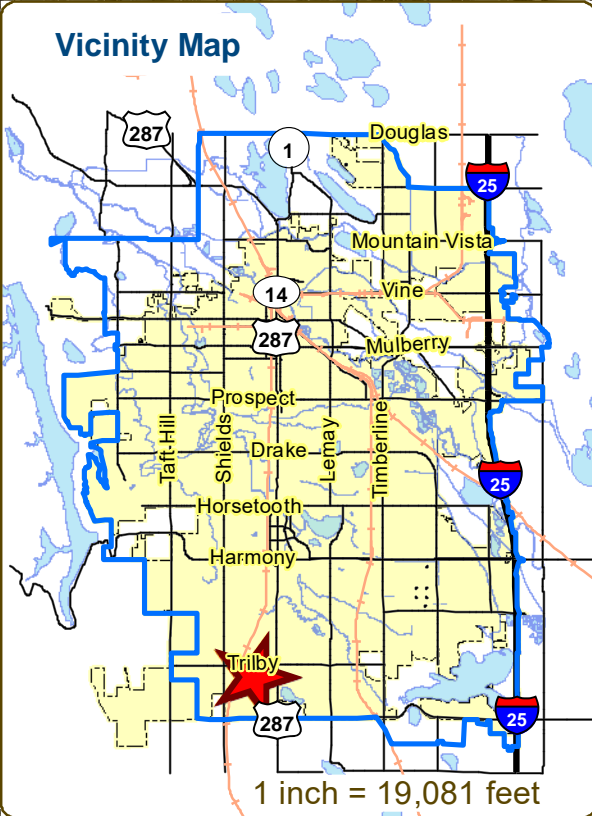

Aerial Site Map



Zoning Map

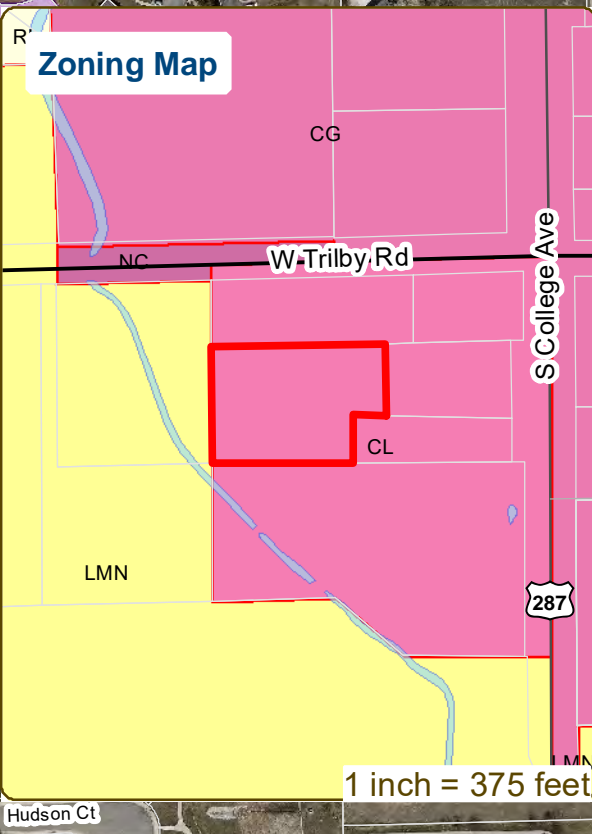

These map products and all underlying data are developed for use by the City of Fort Collins for its internal purposes only, and were not designed or intended for general use by members of the public. The City makes no representation or warranty as to its accuracy, timeliness, or completeness, and in particular, its accuracy in labeling or displaying dimensions, contours, property boundaries, or placement of location of any map features thereon. THE CITY OF FORT COLLINS MAKES NO WARRANTY OF MERCHANTABILITY OR WARRANTY FOR FITNESS OF USE FOR PARTICULAR PURPOSE, EXPRESSED OR IMPLIED, WITH RESPECT TO THESE MAP PRODUCTS OR THE UNDERLYING DATA. Any users of these map products, map applications, or data, accepts same AS IS, WITH ALL FAULTS, and assumes all responsibility of the use thereof, and further covenants and agrees to hold the City harmless from and against all damage, loss, or liability arising from any use of this map product, in consideration of the City's having made this information available. Independent verification of all data contained herein should be obtained by any users of these products, or underlying data. The City disclaims, and shall not be held liable for any and all damage, loss, or liability, whether direct, indirect, or consequential, which arises or may arise from these map products or the use thereof by any person or entity.





DEVELOPMENT REVIEW:
INQUIRY FORM

General Information

This form is a first step to aid prospective applicants in the Fort Collins Development Review process. The more information you are able to provide, the better direction staff will be able to provide on the next steps.

Completed Inquiry Forms can be submitted to the Development Review Center at 281 N College Ave, Fort Collins, CO 80524 or e-mailed to planning@fcgov.com. If you do not have access to e-mail, other accommodations can be made upon request. Please complete this form to the best of your knowledge.

Contact Name(s) and Role(s) (Please identify whether Consultant, Owner, etc)

Business Name (if applicable)

Your Mailing Address

Phone Number Email Address

Site Address or Description

Parcel # Zone District

Proposed Use* Current Use*

*Subject to review by staff based on past approvals/Land Use Code requirements.

Description of Proposal (attach additional sheets if necessary)

Existing DU [] GdUWg Dfc j]XYX 5 XX]h]cbU DU [] GdUWg Dfc dcgYX

HcHJ '6 i]X]b ['Gei UFY: ccHJ Y 'Bi a VYf 'cZGfcf]Yg Property '8]a Ybg]cbg'

Age of any Existing Structures

Is your property in a Flood Plain? [] Yes. [] No. If yes, at what risk is it?

Information available on FC Maps: http://gisweb.fcgov.com/redirect/default.aspx?layerTheme=Floodplains.

Proposed bWYUgY]b -a dYfj]ci g'5 fYU S.F.

(Approximate amount of additional building, pavement, or etc. that will cover existing bare ground to be added to the site)

What specific information are you looking for? (attach additional sheets if necessary)



I acknowledge that any information submitted may be considered a public record, available for review by anyone who requests it, including the media. I acknowledge that all information provided is subject to review through the applicable development review processes and may be shared with other City departments for review. I acknowledge that I am acting with the owner's consent.



DEVELOPMENT REVIEW:
INQUIRY FORM

For Office Use Only:

Development Review Coordinator _____ **Planner** _____

NEXT STEPS:

- Building Permit ONLY
- Minor Amendment
- Conceptual Review
- Basic Development Review (BDR)
- Pre-Submittal Meeting
- Project Development Plan (PDP)
- Neighborhood Meeting (before submittal)

NOTES:

Sketch Area:

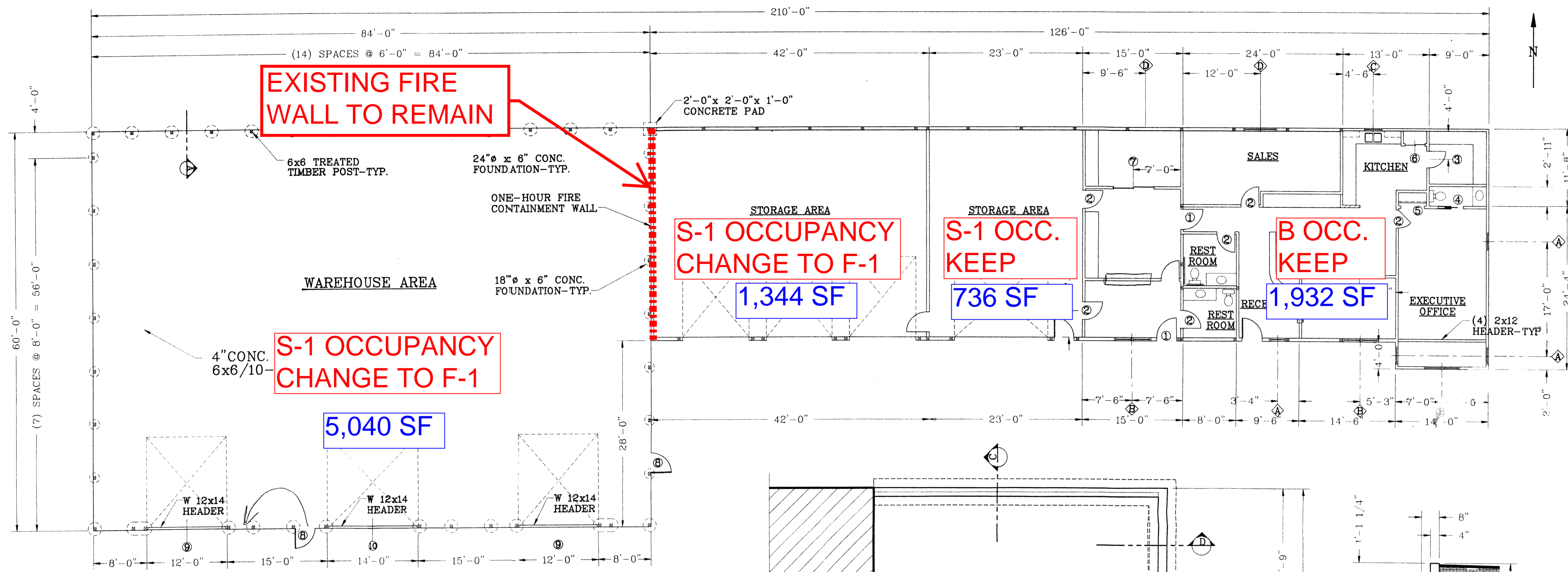

FLOOR PLAN
SCALE 1/8"=1'-0"

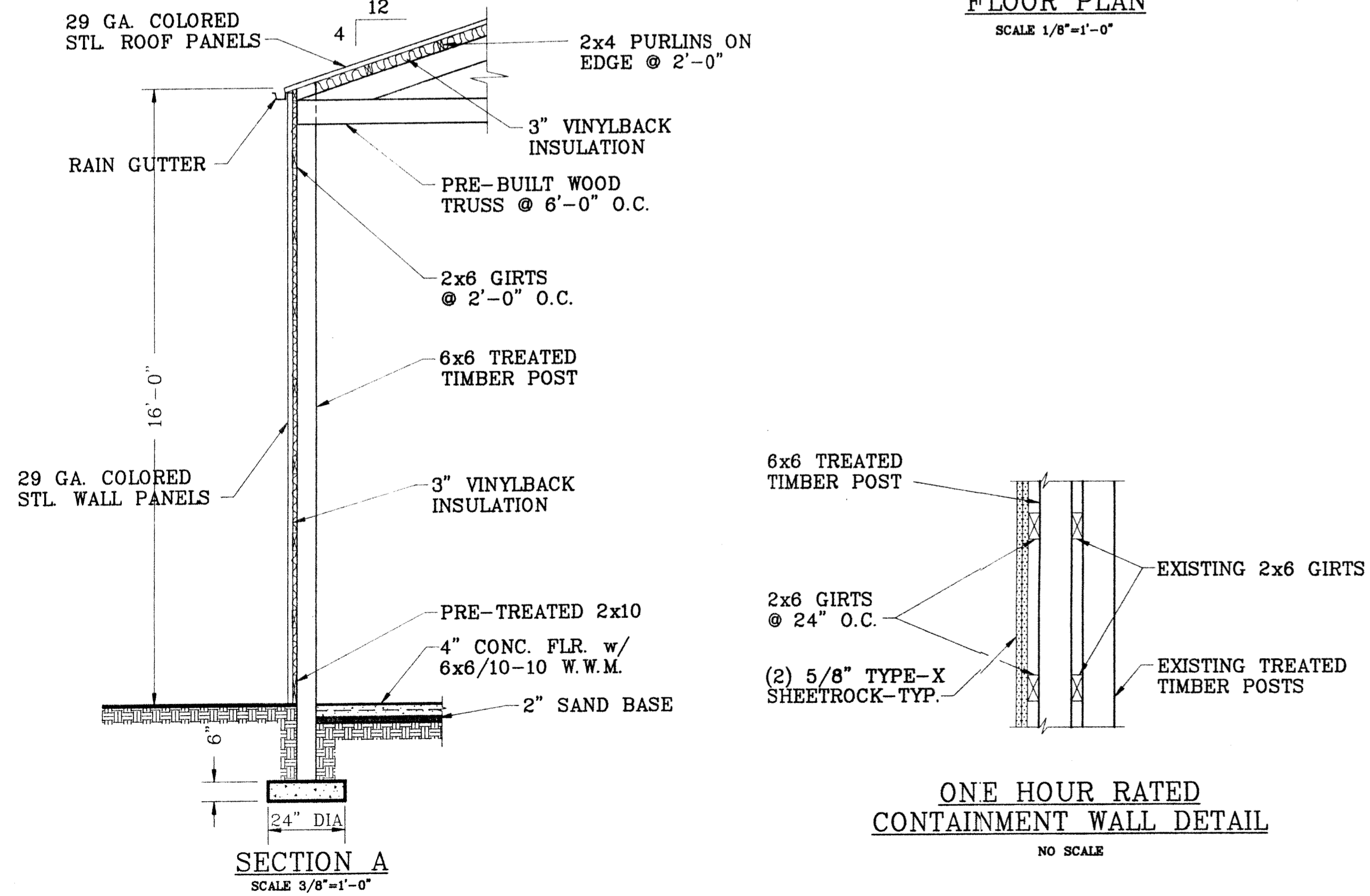

ONE HOUR RATED CONTAINMENT WALL DETAIL
NO SCALE

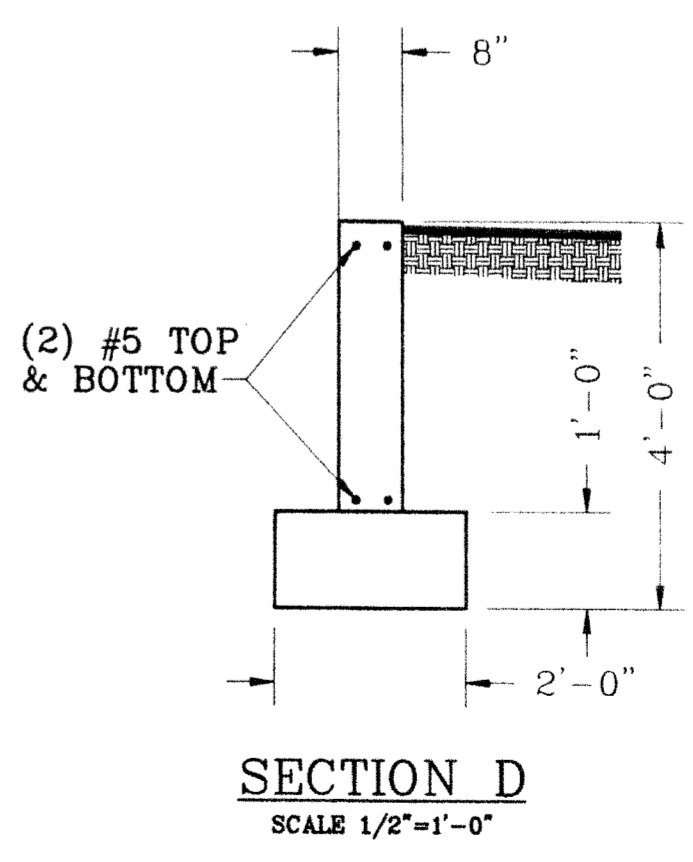
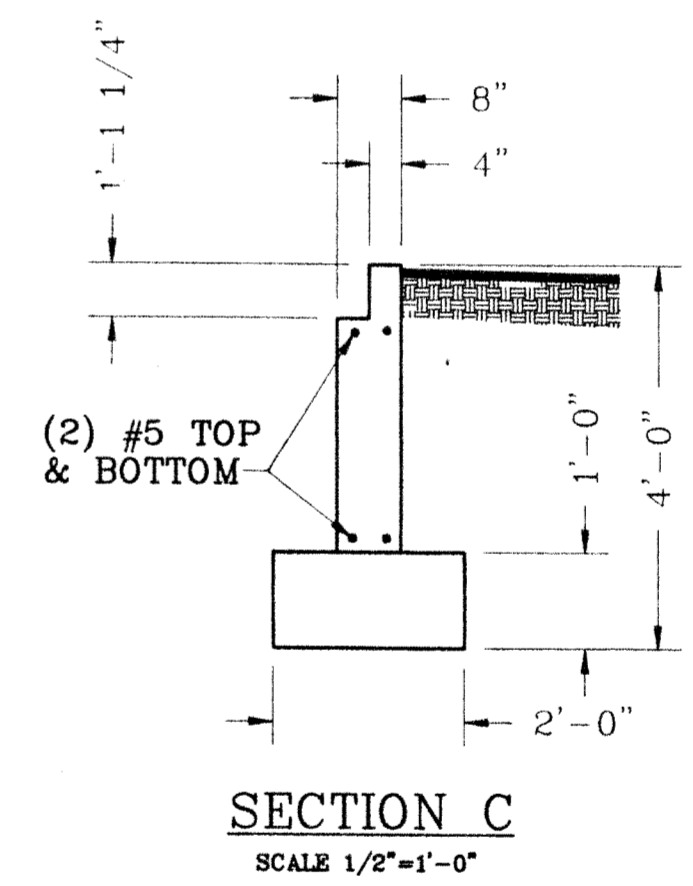
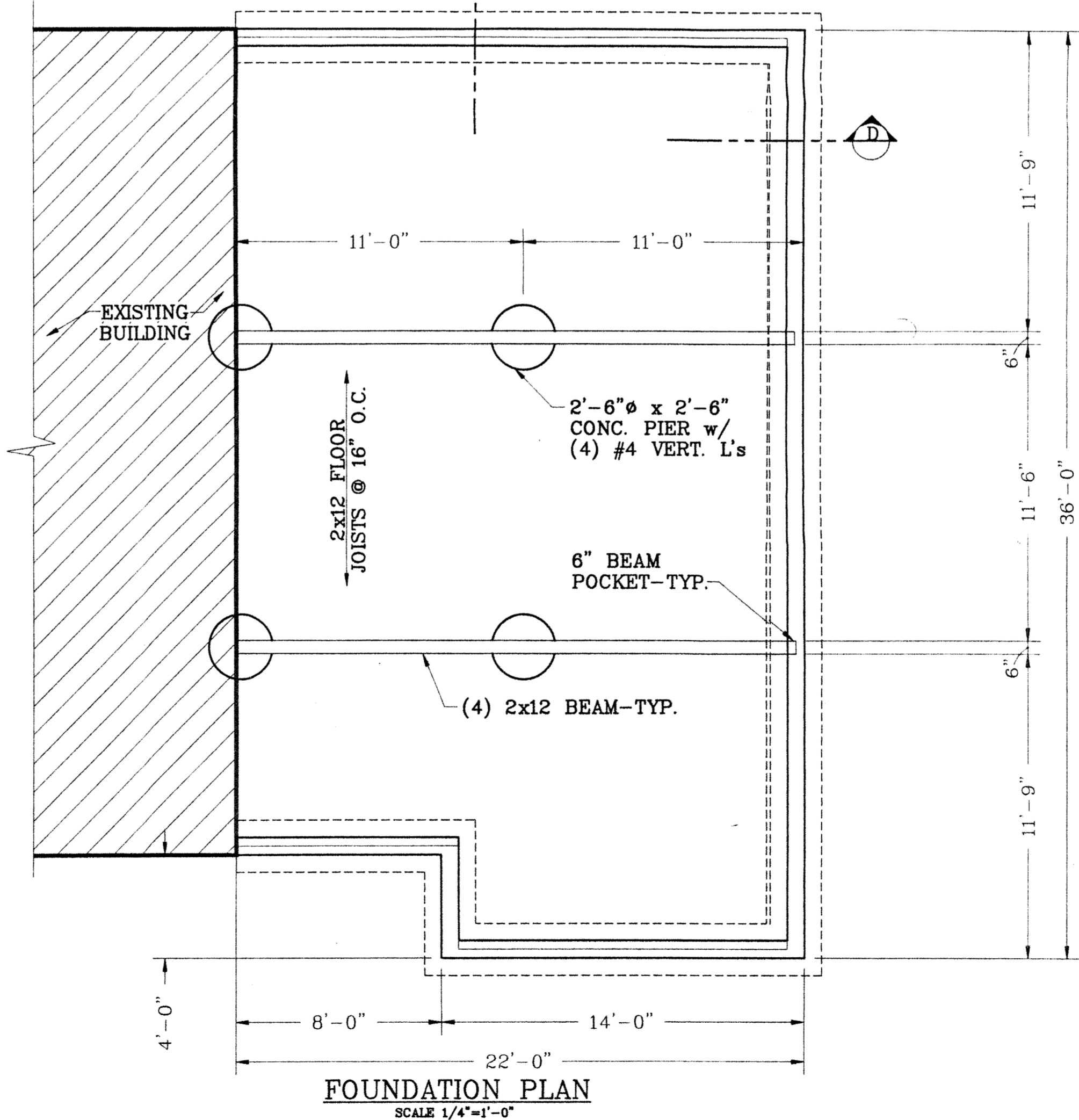

Zoyiopoulos and Associates, Inc.
Engineering Consultants
1011 46th STREET • EVANS, COLORADO 80620 • PHONE 352-6000

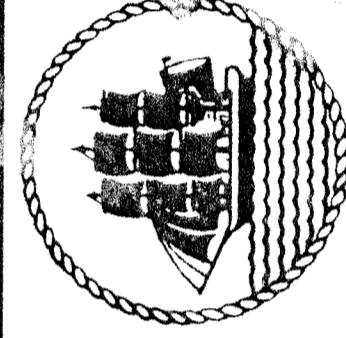

FLOOR PLANS
60'x84' POLE BARN BUILDING REMODEL

DATE	DRAWN BY	CHECKED BY	PROJECT NO.	REVISIONS
11-18-88	J.D.S.		881027-49	

MARK DINGS
THERMAL CONCEPTS INC.
6617 S. COLLEGE

MINOR AMENDMENT

BASIC DEVELOPMENT REVIEW

KIND CARE OF COLORADO - RECREATIONAL MARIJUANA SALES AND CULTIVATION FACILITY

LOT 1 OF DINGS SUBDIVISION

6617 S. COLLEGE AVENUE FORT COLLINS, COLORADO 80525

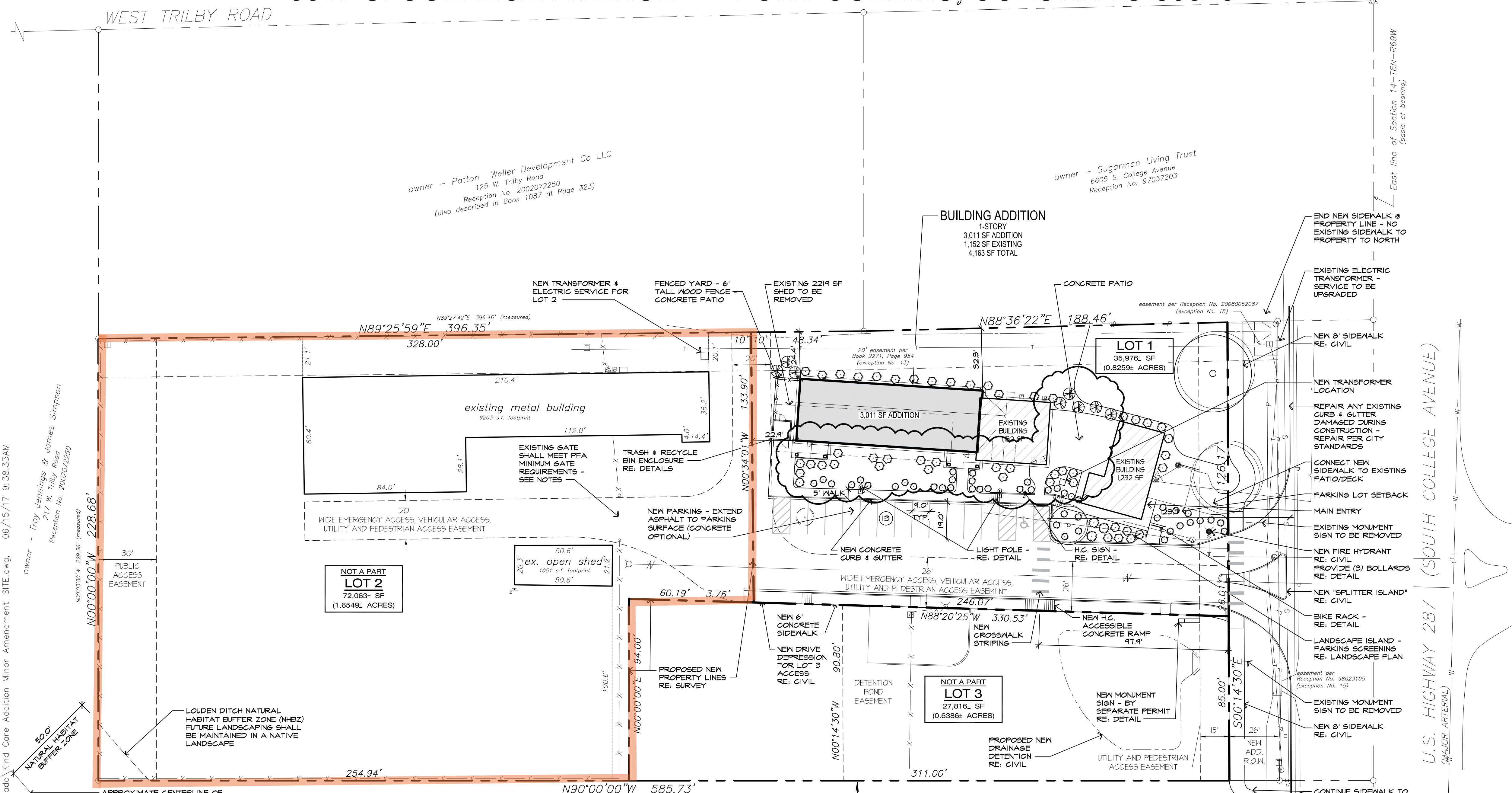

LEGAL DESCRIPTION:

LOT 1:
LOT 1 OF DINGS SUBDIVISION, CITY OF FORT COLLINS,
COUNTY OF LARIMER, STATE OF COLORADO
(35,976 SF)

LOT 2:
NOT A PART

LOT 3:
NOT A PART

STREET ADDRESS:
LOT 1:
6617 S. COLLEGE AVENUE
FORT COLLINS, CO 80525

LOT 1 - LAND USE DATA TABLE:

	TOTAL	
BUILDING FOOTPRINTS	5,395 SF	15.00%
PAVED AREAS		
(PARKING, WALKS & DRIVES)	16,300 SF	45.31%
AREA OF LANDSCAPING:	14,281 SF	39.69%
TOTAL LOT AREA:	35,976 SF	100.00%
	(0.83 ACRES)	

LOT 1 - SITE DATA:

PARCEL NUMBER:
96141-00-010

ZONING:
LIMITED COMMERCIAL (CL)

ADJACENT ZONING:
NORTH = LIMITED COMMERCIAL (CL)
SOUTH = LIMITED COMMERCIAL (CL)
EAST = GENERAL COMMERCIAL (CG)
WEST = LOW DENSITY MIXED-USE
NEIGHBORHOOD (LMN)

TOTAL SITE AREA:
35,976 SF (0.8259 ACRES)

TOTAL BUILDING AREAS:
EAST BUILDING:
1,232 SF (EXISTING 1-STORY)

WEST BUILDING:
1,152 SF (EXISTING 1-STORY)
3,011 SF 1-STORY ADDITION
4,163 SF TOTAL

OCCUPANCY:
F-1 (MARIJUANA CULTIVATION)
M (MARIJUANA SALES)
B (OFFICES)

CONSTRUCTION TYPE:
V-B (NON-SPRINKLED)

LOT 1 - PARKING SUMMARY:

TOTAL PARKING PROVIDED: = 13 SPACES
(INCLUDES 1 VAN ACCESSIBLE
HANDICAPPED SPACE)

NEW BIKE RACK LOCATED NEAR EAST BLDG. ENTRY

TRAFFIC SUMMARY:

LOT 1 - KIND CARE:

EXISTING:	
NUMBER OF EMPLOYEES ON SITE EACH DAY	7
NUMBER OF VENDORS ON SITE EACH DAY	1
NUMBER OF CUSTOMERS ON SITE EACH DAY	80
AVERAGE TRIPS PER DAY	176

PROPOSED:

NUMBER OF EMPLOYEES ON SITE EACH DAY	7
NUMBER OF VENDORS ON SITE EACH DAY	1
NUMBER OF CUSTOMERS ON SITE EACH DAY	90
AVERAGE TRIPS PER DAY	196

PREPARED BY:
HAUSER ARCHITECTS, P.C.
ALAN HAUSER, PROJECT ARCHITECT
BJ DEFORGE, PROJECT MANAGER
3780 EAST 15TH STREET, SUITE 201
LOVELAND, CO 80538
PHONE: 970.669.8220
EMAIL: AL@HAUSERARCHITECTSPC.COM
EMAIL: BJ@HAUSERARCHITECTSPC.COM

PROPERTY OWNER:
6617 SOUTH COLLEGE LLC
MARK DINGS - MANAGER
702 W. DRAKE ROAD, BUILDING D
FORT COLLINS, COLORADO 80526
PHONE: 970.222.7057
EMAIL: mwd538@gmail.com

LEGAL DESCRIPTION:

LOT 1:
LOT 1 OF DINGS SUBDIVISION, CITY OF FORT COLLINS,
COUNTY OF LARIMER, STATE OF COLORADO
(35,976 SF)

HAUSER
ARCHITECTS
3780 East 15th Street, Suite 201 • Loveland, Colorado 80538
970.669.8220
E-mail: info@hauserarchitectspc.com

MINOR AMENDMENT - BDR
KIND CARE OF COLORADO
RECREATIONAL MARIJUANA SALES AND CULTIVATION FACILITY EXPANSION
6617 S. COLLEGE AVENUE FORT COLLINS, COLORADO 80525
SITE PLAN

PROJECT NO.	DATE	BY
BDR MINOR AMENDMENT	5/22/17	BJD
BDR MINOR AMENDMENT - ROAD 2	6/15/17	BJD

Hauser Architects, P.C. C:\BUD_Current.dwg\Kind Care Addition Minor Amendment_SITE.dwg, 06/15/17 9:38:33AM
 owner - Troy Jennings & James Simpson
 217 W. Trilby Road
 Reception No. 2002072250
 800' NATURAL HABITAT BUFFER ZONE
 100' PUBLIC ACCESS EASEMENT
 owner - Patton Weller Development Co LLC
 125 W. Trilby Road
 Reception No. 2002072250
 (also described in Book 1087 at Page 323)
 owner - Sugarman Living Trust
 6605 S. College Avenue
 Reception No. 97037203
 owner - PSC Fort Collins LLC
 6705 S. College Avenue
 Reception No. 2002072250
 U.S. HIGHWAY 287 (MAJOR ARTERIAL) (SOUTH COLLEGE AVENUE)
 EAST LINE OF SECTION 14-T6N-R69W (basis of bearing)

OWNER'S CERTIFICATION

The undersigned do hereby certify that I/we are the lawful owners of real property described on this site plan and do hereby certify that I/we accept the conditions and restrictions set forth on said site plan.

Owner (signed) _____ Date _____

(State of _____)

(County of _____)

Subscribed and sworn to before me this _____ day of _____, 20____ A.D. by _____

WITNESS my hand and official seal.

Notary Public _____

Address _____

My Commission Expires _____

DIRECTOR OF COMMUNITY DEVELOPMENT AND NEIGHBORHOOD SERVICES

Approved by the Director of Planning of the City of Fort Collins, Colorado, this _____ day of _____, 20____ A.D.

Director of Community Development and Neighborhood Services _____

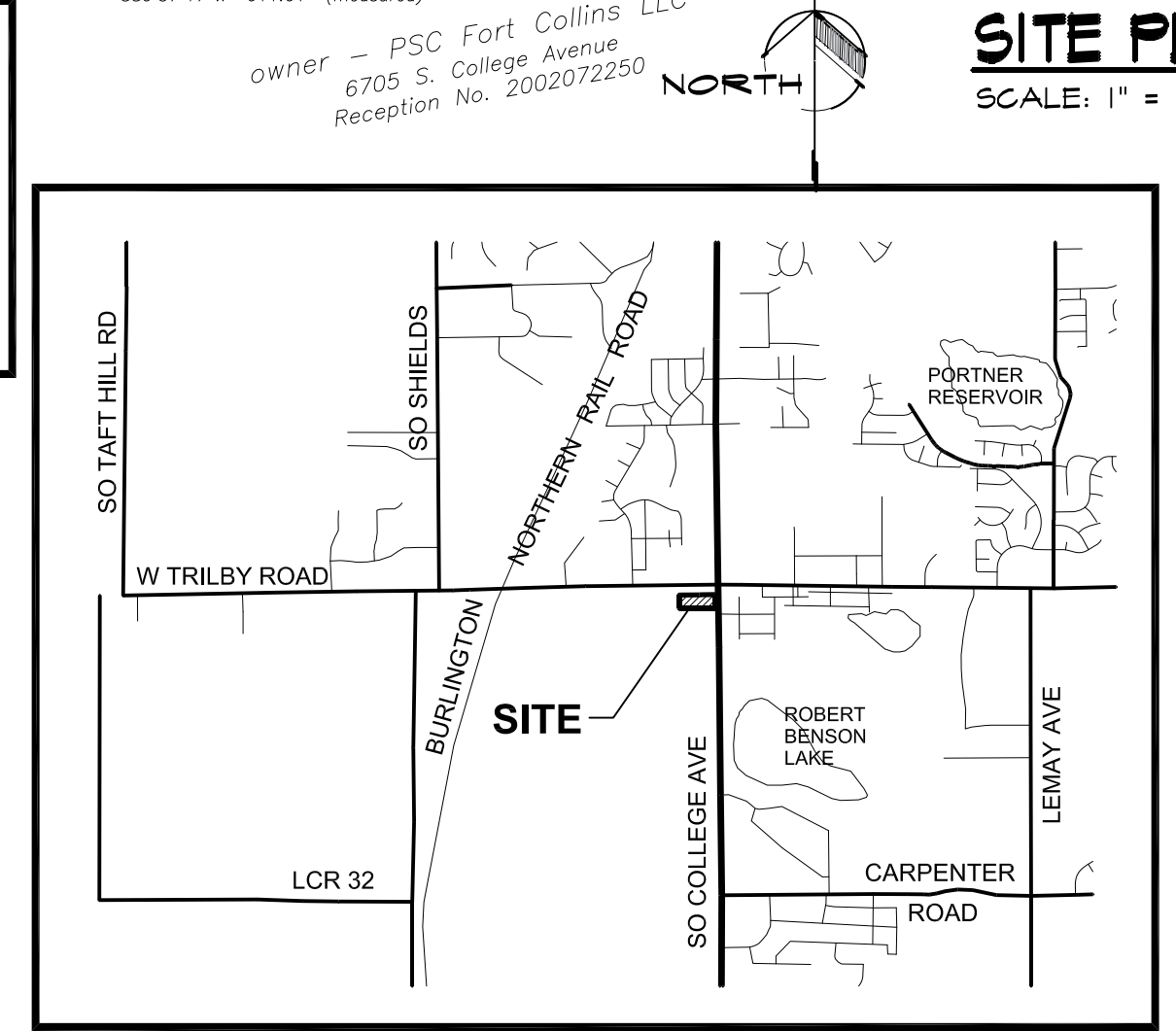

Expanding Horizon Farm

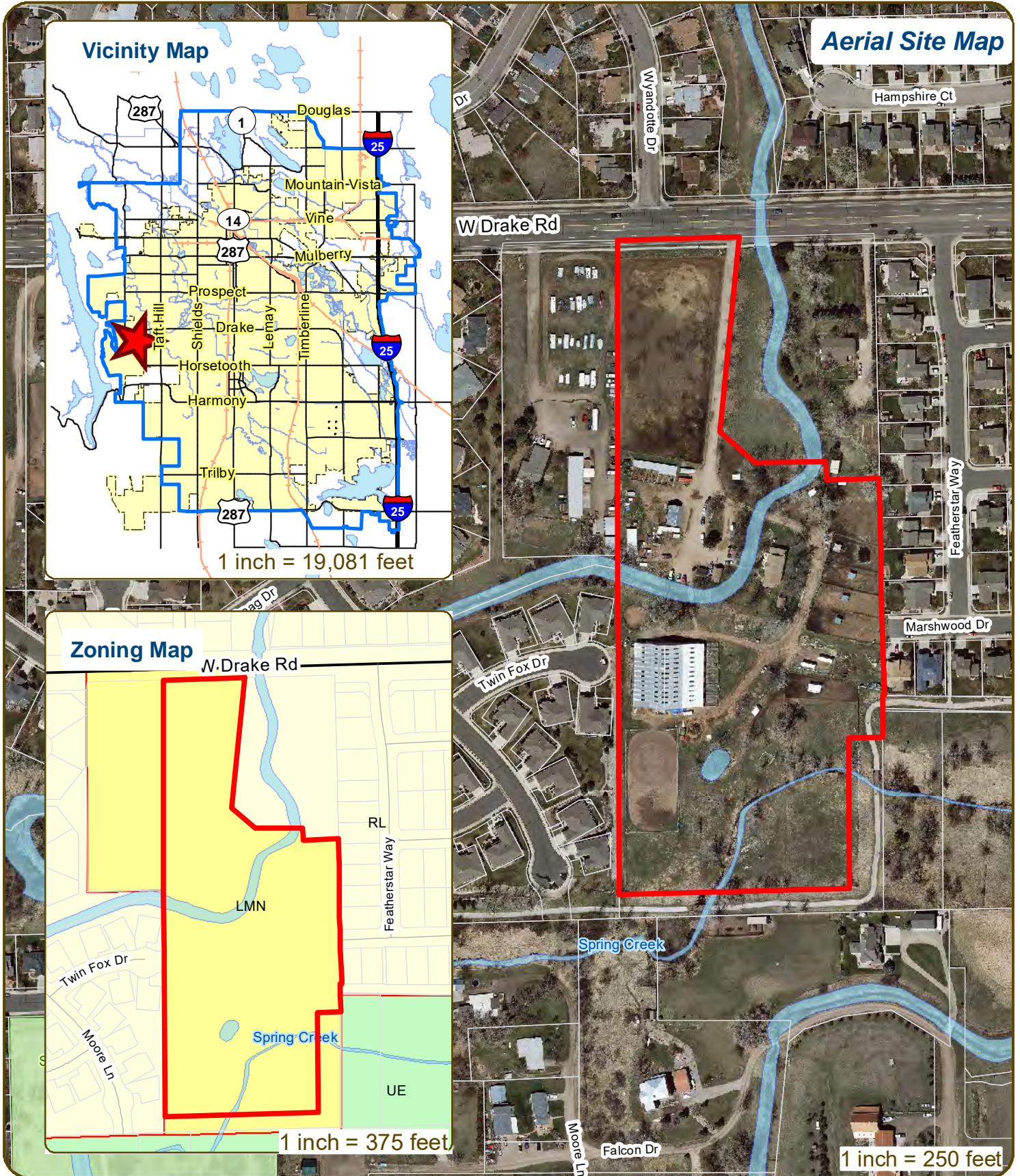

These map products and all underlying data are developed for use by the City of Fort Collins for its internal purposes only, and were not designed or intended for general use by members of the public. The City makes no representation or warranty as to its accuracy, timeliness, or completeness, and in particular, its accuracy in labeling or displaying dimensions, contours, property boundaries, or placement of location of any map features thereon. THE CITY OF FORT COLLINS MAKES NO WARRANTY OF MERCHANTABILITY OR WARRANTY FOR FITNESS OF USE FOR PARTICULAR PURPOSE, EXPRESSED OR IMPLIED, WITH RESPECT TO THESE MAP PRODUCTS OR THE UNDERLYING DATA. Any users of these map products, map applications, or data, accepts same AS IS, WITH ALL FAULTS, and assumes all responsibility of the use thereof, and further covenants and agrees to hold the City harmless from and against all damage, loss, or liability arising from any use of this map product, in consideration of the City's having made this information available. Independent verification of all data contained herein should be obtained by any users of these products, or underlying data. The City disclaims, and shall not be held liable for any and all damage, loss, or liability, whether direct, indirect, or consequential, which arises or may arise from these map products or the use thereof by any person or entity.





CONCEPTUAL REVIEW: APPLICATION

General Information

All proposed development projects begin with Conceptual Review. Anyone with a development idea can schedule a Conceptual Review meeting to get feedback on prospective development ideas. At this stage, the development idea does not need to be finalized or professionally presented. However, a sketch plan and this application must be submitted to City Staff prior to the Conceptual Review meeting. The more information you are able to provide, the better feedback you are likely to get from the meeting. Please be aware that any information submitted may be considered a public record, available for review by anyone who requests it, including the media. The applicant acknowledges that they are acting with the owner's consent.

Conceptual Reviews are scheduled on three Thursday mornings per month on a "first come, first served" basis and are a free service. One 45 meeting is allocated per applicant and only three conceptual reviews are done each Thursday morning. A completed application must be submitted to reserve a Conceptual Review time slot. Complete applications and sketch plans must be submitted to City Staff on Thursday, no later than end of day, two weeks prior to the meeting date. Application materials must be e-mailed to currentplanning@fcgov.com. If you do not have access to e-mail, other accommodations can be made upon request.

At Conceptual Review, you will meet with Staff from a number of City departments, such as Community Development and Neighborhood Services (Zoning, Current Planning, and Development Review Engineering), Light and Power, Stormwater, Water/Waste Water, Advance Planning (Long Range Planning and Transportation Planning) and Poudre Fire Authority. Comments are offered by staff to assist you in preparing the detailed components of the project application. There is no approval or denial of development proposals associated with Conceptual Review. At the meeting you will be presented with a letter from staff, summarizing comments on your proposal.

BOLDED ITEMS ARE REQUIRED *The more info provided, the more detailed your comments from staff will be.*

Contact Name(s) and Role(s) (Please identify whether Consultant or Owner, etc) _____

Emma Englesby (Purchaser)

Business Name (if applicable) Expanding Horizons Farm INC

Your Mailing Address P.O. Box 272923 Fort Collins CO 80527

Phone Number 970.658.6281 Email Address expandinghorizonsfarm@gmail.com

Site Address or Description (parcel # if no address) _____

2407 W Drake RD. Fort Collins, CO 80526

Description of Proposal (attach additional sheets if necessary) see attached

Proposed Use Year-round Agricultural Education Program Existing Use Horse boarding facility

Total Building Square Footage ? S.F. Number of Stories ? Lot Dimensions ?

Age of any Existing Structures Ranges from 1910-1980's

Info available on Larimer County's Website: http://www.co.larimer.co.us/assessor/query/search.cfm

If any structures are 50+ years old, good quality, color photos of all sides of the structure are required for conceptual.

Is your property in a Flood Plain? Yes No If yes, then at what risk is it? moderate to high for 100 year

Info available on FC Maps: http://gisweb.fcgov.com/redirect/default.aspx?layerTheme=Floodplains.

Increase in Impervious Area ? S.F.

(Approximate amount of additional building, pavement, or etc. that will cover existing bare ground to be added to the site)

Suggested items for the Sketch Plan:

Property location and boundaries, surrounding land uses, proposed use(s), existing and proposed improvements (buildings, landscaping, parking/drive areas, water treatment/detention, drainage), existing natural features (water bodies, wetlands, large trees, wildlife, canals, irrigation ditches), utility line locations (if known), photographs (helpful but not required). Things to consider when making a proposal: How does the site drain now? Will it change? If so, what will change?



W DRAKE ROAD

EXISTING DRIVEWAY
EXISTING SIGNAGE

PROPERTY LINE

OPEN CASH CROP
(RAISED PLANTING
BEDS, OPEN CROPS)

FEATHERSTAR WAY

RAISED PLANTING BEDS

NEW GREEN HOUSE

UPPER RUNS

HISTORIC MILKING BARN

PARKING

EXISTING GARAGE

CHICKEN COOP

CSA FARM STAND
(EXISTING GARAGE)

PARKING

PLEASANT VALLEY & LAKE CANAL

PEDESTRIAN BRIDGE

EXISTING ROUND PEN

EXISTING BARN

INDOOR ARENA

TWIN FOX DR.

FEED LOT

EXISTING IRRIGATION
HOLDING POND

EXISTING
OUTDOOR
ARENA

LARGE COW
PASTURE

SMALL COW
PASTURE

HORSE
PASTURE

PATH CONNECTION TO
SPRING CREEK TRAIL

PROPERTY LINE

SPRING CREEK

SPRING CREEK TRAIL

FRUIT ORCHARD

ORCHARD STORAGE

VEHICULAR BRIDGE
OVER CANAL

EXISTING RESIDENCE
GARDEN SHED

EXISTING PADDOCKS

MARSHWOOD DR.

EXISTING
EQUIPMENT STORAGE

PROPERTY LINE

EXISTING PADDOCKS

100 YEAR
FLOODWAY

FLOODWAY

100 YEAR

TANGLEWOOD
NATURAL AREA

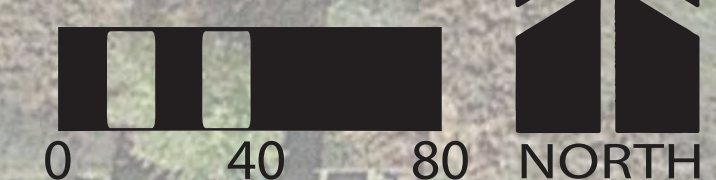

2019

Conceptual Review 2407 West Drake Road



Emma Englesby

Expanding Horizons Farm

3/10/2019

Table of Contents

- Introduction to Expanding Horizons Farm
- Property location and boundaries
- Surrounding land uses
- Proposed use(s)
- Existing and proposed improvements
- Existing natural features
- Utility line locations (if known)
- Closing remarks

Expanding Horizons Farm

An Introduction

○ **Mission**

The mission of Expanding Horizons Farm is to teach children about sustainable living and finding their sustenance in God through biblical and agricultural education.

○ **Vision Statement**

We aim to provide a life-giving, purpose-filled experience to children in and around the Fort Collins area. Expanding Horizons Farm introduces participants to different aspects of cultivating sustainable living practices while providing a safe, clean, exciting environment where kids can engage in respectful and interactive relationships that encourage spiritual and intellectual growth. This program is for families of any socioeconomic class. We reach the community by being a part of the community.

BUSINESS SUMMARY

Expanding Horizons Farm currently operates as a week-long summer camp experience focusing on biblical and agricultural education. Currently, we host 5 sessions of the week-long program during the summer months from June to August. Expanding Horizons Farm prides itself in offering hands-on applied bible study. The experiences gained through participation in Expanding Horizons Farm help children to make deep spiritual connections in their day-to-day life. As program participants engage in fulfilling experiences on the farm, we are assured that they will expand their horizons and live in a way that reflects healthy stewardship of this world, themselves, and others.

Expanding Horizons Farm began in May of 2015 on a private property that allowed us access to many different aspects of a sustainable farm. This type of facility granted us the freedom to experience the lessons in a tangible way as we invested time in all the different areas of the farm. After a barn fire in 2017 precluded us from continuing camp at the property, we pioneered the idea of partnering with different locations for each day of the week. Each location was carefully chosen to fit the theme of the daily lesson. We partnered with 5 different locations in 2017 and currently, we have the same structure. This was never a permanent solution as it has always been the goal to be on one property. Our current style of operation is not the most conducive way to make the impact we hope for within the community and among our participants. Acquiring a property like that of Town and Country Stables would allow us to reach our full potential and offer more than just 5 weeks of summer camp. The property would allow us to intentionally invest in the surrounding community.

○ **Services:**

Featured Activities:

- Gardening
- Horseback riding
- Lesson-based crafts and sustainable projects
- Lessons centered on creation and sustainable living
- Interacting with and caring for multiple species of animals
- Discovering healthy nutrition for animals and ourselves

Each session has a similar lesson plan which builds upon itself.

The themes covered are primarily focused on:

- Cultivating healthy relationships
- Living intentionally and with eyes for details
- Exploring sustenance and sustainable living
- Life-giving communication practices
- Experiencing restoration and hope

Through each week we are attentive to what the group needs to grow in, as well as specific questions that may arise as we dig through biblical and scientific facts. The interactive nature of the lessons encourages participants to ask questions and discover truths through constructive conversation pertaining to each of our topics and other points that are brought to light through the week.

Expanding Horizons Farm offers a unique service to the City of Fort Collins, in that no other farm or camp program integrates faith and agriculture. Children are introduced to new skills and ideas while strengthening their relationships with God. Science and Scripture are wonderful tools to awaken awe and wonder in us all, and at EHF we feel that it is important to invest in children and allow them to “Expand their Horizons”.

Parents of participants can expect to see their child:

- Gain a stronger sense of responsibility and stewardship
- Deepen their understanding of their innate value and purpose
- Explore the intricacies of gardening and animal care through hands-on experience

Property Location and Boundaries

Location: 2407 West Drake Rd. Fort Collins, CO 80526

The property is nestled in the subdivisions on West Drake road, between Taft Hill and Overland. The central location of this property is optimal for participant and community access. The location also enables us to participate in events around town, such as farmers markets, town and area clean up, and art festivals. Upon acquiring the property, a massive cleanup of the property, irrigation ditch and the surrounding Spring Creek Trail is one of my priorities. It is my heart to create a radiating environment of health and well-being, inviting other to take ownership in the delightful process of restoration and stewardship.

The property is 10.89 acres with two potential easements on the property. There seems to be a section that is covering the spring creek trail to the east, and a section that is fenced in that is not technically the property. The legalities of this are to be discussed. Access to the spring creek trail and Pineridge Natural area are wonderful attributes of the property and would allow for Expanding Horizons Farm to enjoy “field trips” off the property.



Surrounding Land Uses

The land surrounding Town and Country Stables has many uses, from housing and horse properties, to condominiums and shopping centers, and most importantly natural areas and community parks. The subdivisions around the property include Fox Creek, Quail Hollow, Hampshire Pond, and Hampshire square. Small lot subdivision homes are located to the west, north, and east of the property. To the southeast there resides Tanglewood Natural Area and larger housing lots, with acreage used for horse properties. The spring creek trail runs along the east and south-east edge of the property and leads to the spring canyon park and Pine Ridge Natural area.

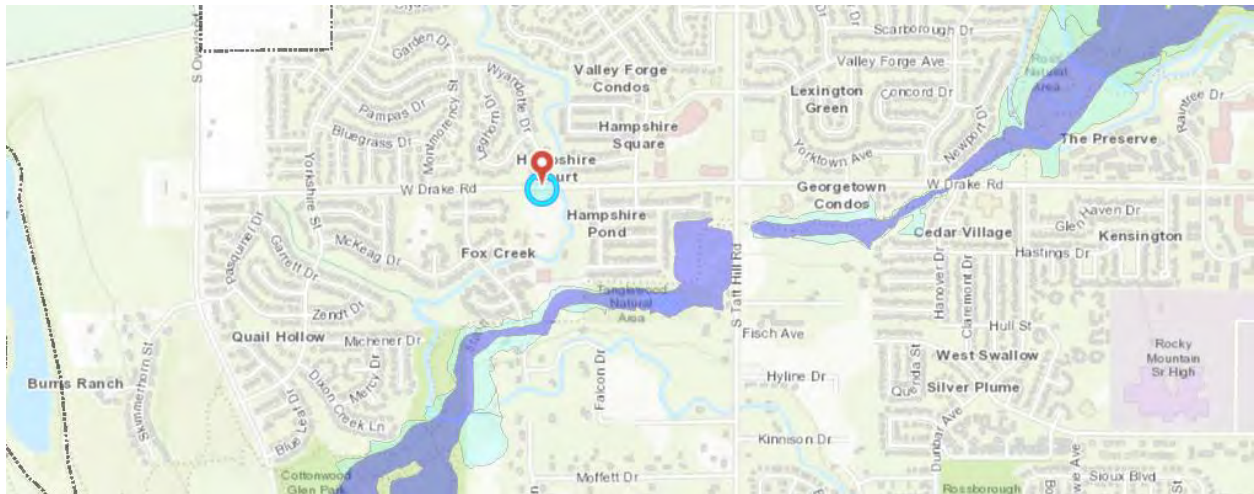

Proposed Use(s)

To maximize this property, Expanding Horizons Farm will be operational year-round as an educational facility that includes gardening, horseback riding and sustainability projects. Our operations will include:

Children's Biblical and Agricultural Education Program

Expanding Horizons Farm will operate as an after-school program during the school year and continue as a camp during the summer months. We will also continue as a riding facility while offering weekend open houses for the garden and animal care clinics. Our programs will be integrative for individuals with special needs and from marginalized populations. It has always been the heart of Expanding Horizons Farm to have a set location as a place of sustained ownership and investment. As we expand, Expanding Horizons Farm will offer internships and apprenticeship opportunities for college and high school students who are interested in agricultural operations.

CSA Production

The property will continue to support cattle, horses, goats, dogs, and cats. A large chicken coup, a garden with raised beds, a green house, hoop house, and hydroponic/aquaponic garden will be added. These additions will benefit the community by providing hands-on learning for program participants and volunteers. These structures will also create an opportunity for partnerships with local charitable organizations and businesses as we share the produce. The organizations we currently have in mind include FoCo Café, the Food Bank, Fort Collins Rescue Mission, and Fort Collins Food Co-Op. Partners and participants will be able to contribute and enjoy food from the garden. Upon establishing the garden, we will explore the possibility of creating a CSA with sold shares to support the Farm. Expanding Horizons Farm also envisions incorporating a hydroponic/aquaponic system. We currently own a small, 4-tower system that has the capability of housing 6-10 fish, depending on size. The herbs that will be grow in this system can also be distributed to participants and sold to the community. With cattle on the property we would also feed to market and then sell/donate the meat to participants and local organizations.

Horse Boarding

The property will continue its operation as a horse boarding facility to the maximum capacity allowed by the City of Fort Collins. As the number of allowable boarded horses will decrease with the sale of the property, we will raise boarding costs with consideration to industry averages to compensate for the variance. The horses that are on the property will be used for educational purposes as allowed by the owners. These purposes include feeding, stall care, and veterinary care clinics. This property is favorable for college students due to its location and ease of access. This will bring in the necessary boarders.

Existing and Proposed Improvements:

Legend:

- Red = Existing Structures
- Blue = Existing Structure but will need improvements
- Green = Proposed Improvements (Not necessary right away)

Round Pen: The round pen needs to have a drainage point added in the south west side



Indoor Arena: The indoor arena needs only consistent watering to be at a more optimal condition.



Outdoor Arena: The outdoor arena needs a drainage area in the southeast corner.



Garage: located to the southwest of the house.



Garden shed: located directly south of the house



Pastures:

Red line: Small cow pasture, Rainbow line: Large cow pasture, Black line: Horse paddock and pasture

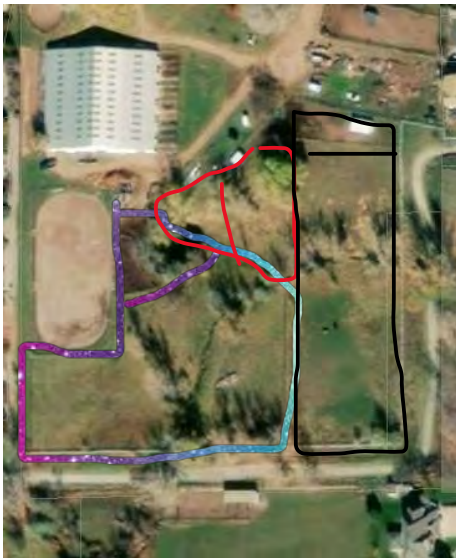

West side of barn: The west side of the barn is ideal for the smaller livestock and bottle-fed animals.



East Side of barn: This side of the barn is more ideal for horse boarding than the west side of the barn. There are improvements and renovations that are needed for safety and maintenance. The aisle needs to be leveled, some doors need to be rebuilt, and the mats in the outside runs need to be removed.

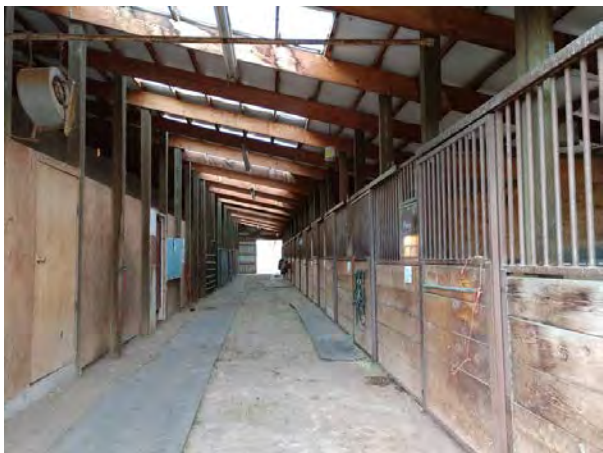

Paddocks and upper runs: Expanding Horizons Farm would keep the 4 paddocks that lie to the east of the property. There would be one horse per paddock with the price increased to \$400-\$450/paddock. The runs to the north of the historic barn would also be available for boarding. The only improvement for the north runs would be access to an electrical outlet during the winter for water heaters. The nearest electrical line I am aware of is within the historic barn.



Historic Milking Barn: If possible, I would like to register the historic portions of the farm (including, but not limited to, the house and the original milking barn) with the Historic society, so that we can maximize the care and preservation of the history on the property. After this, if the society allows, I would like to restore the barn ensuring its structurally sound, and turn it into a place of rich exploration and fun. This would look like rope and tire swings inside the barn so that it can be used year-round. I would also like to be able to build a climbing wall within the attic and allow for children to explore new heights. The dreams will unfold eventually, I just want to be sure to include all that might occur on the property.

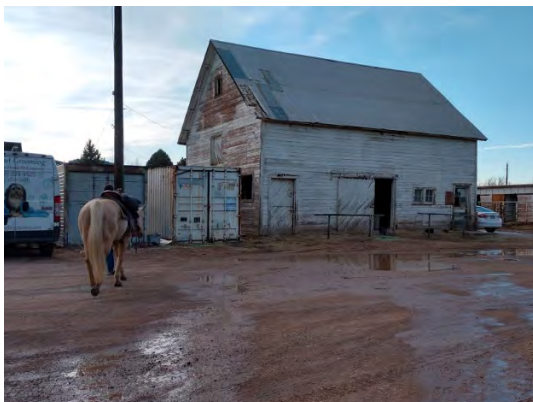

Chicken Coup: The chicken coup would be established in the old tool shed. There would need to be added one or two lockable doors to the back that allow the hens out during the day into the enclosed area. The eggs could also be sold as part of the CSA



Orchard and CSA Farm stand: I would like to have multiple fruit trees including apple, cherry, peach, pear and plum. The variety of trees will provide the participants and the community with a greater understanding of how different trees grow and produce fruit and their specific care and needs. We would also have several berry varieties. The different fruits produced will be harvested and sold as part of the program in sustainable and ethical business practices. Participants will be able to design and market their own fruit stand labels and learn first-hand how to communicate with customers, market products for sale and handle money. We will convert the garage and work shed area into a farm stand. Farm stand hours will have to be determined and coincide with the times that program participants will be there to help sell their produce.



Green House: A green house on the property will allow for year-round growth and production. As of right now I envision having one large greenhouse (to start with) that is equipped with roll-up sides and enough space to fit 4 rows of various crops. The fullness of the vision will have to be planned out as we develop the space to its fullest potential. Ideally the greenhouse would be where we grow our more delicate and desired year-round crops.



Open Cash Crop: The front pasture will also hold the sun crops and any other grain we decide to produce.

Orchard: Several fruit trees will be added to the far north paddocks that are closest to the irrigation ditch. Trees to be added would come from Fort Collins Nursery, including Honeycrisp Apples, Bali cherries, peaches, pears, and plums

Raised Bed Garden/ Mini raised hoop houses: The design and location of the raised bed garden would vary but could potentially be to the south west of the upper boarding paddocks and directly to the west of the historic milking barn. I would prefer if the structure was enclosed as to reduce theft, and consumption by wildlife. Several ideas are shown below



Parking and Driveway: The driveway needs to be grated. Drive way and parking lots will remain dirt. Driveways are highlighted in yellow (including delivery/feed cart drive). Parking is in red (car and trailer).



Existing Natural Features

Water: There currently is an irrigation ditch (red line) that runs roughly from the northeast through the middle of the property to the southwest. There is also the Spring Creek that runs through (shown as the floodplain on the below map). The property also has one holding pond (purple highlighted area). I am also aware that the basement of the house floods often and there is a sump pump that brings the water out and allows the yard to be watered around the house. During storms the water also flows through the area highlighted in green into the retention pond.



Trees: There will be no tree removal, only the addition of the fruit trees in the orchard area. Currently there are Oak, Maple, and Cottonwood trees on the property.

Wildlife: In terms of wildlife, we have experienced racoons, deer, bear, coyotes, bobcats, and mountain lion (in years past). There has also been Elk (so I have been told). The property is also home to ducks and two swans that come during the summer and live in the irrigation ditch. It is one of my top priorities to restore and clear out the ditch, as it has become incredibly trashed in the last several years. Wild life is more than welcome as long as the horses are safe, and our profitability is not compromised. We will do our best to construct all garden additions with proper enclosures to avoid deer, rabbits, and racoons eating the garden.

Utility Lines

Most of the utility lines are unknown at this time, but several powerlines and light poles exist on the property.

Closing Remarks

This is my preliminary plan in attempts to keep this property operating as an agricultural space that benefits the Fort Collins community. I am happy to comply with the City and get creative with placements of proposed improvement, animal quantities and species, and any other overlooked detail. Thank you for your time and consideration in this process. I look forward to continuing to work with you.